

# Serie DMNI6

Información general de los modelos DMNI63CF, DMNI64CF, DMNI65CF y DMNI66CF.



Foto DMNI66CF

## Descripción



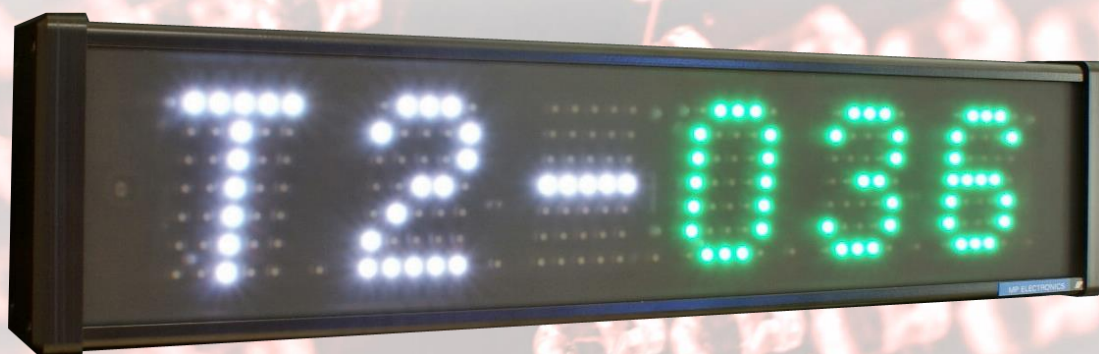

- El **DMNI6\_CF** es un producto de la serie DMNI de marcadores numéricos con tecnología RGB. Dispone de una altura de carácter de 6 cm, obteniendo una distancia máxima de legibilidad de 25 m.
- Los dígitos se representan a través de una matriz de LEDs de 5x7 píxeles para mayor estética de visualización.
- Los marcadores pueden ser de 3, 4, 5 o 6 dígitos según el modelo.
- Los LEDs RGB permiten escoger entre los colores rojo, verde, ámbar, azul, cian, magenta y blanco.
- Dispone de sensor de luminosidad para ajustar de manera automática la intensidad de los LEDs según la luminosidad.
- Diseñado para ambientes de interior y exterior.
- Comunicación nativa mini USB.
- Permite además escoger un módulo de comunicación según necesidades. En el apartado comunicaciones se detallan todas las posibilidades.
- Software MPTools para Windows. Este software nos permite establecer valores numéricos, así como modificar su configuración.
- Es posible establecer unos umbrales de colores mediante el software MPTools para que se modifique el color de forma automática según el valor que representa.
- El chasis está fabricado mediante el uso de perfil de aluminio extrusionado, garantizando la máxima robustez del equipo, así como su mínimo peso.
- Además, se utilizan materiales de altas prestaciones con el fin de otorgar al producto una gran durabilidad.



## Especificaciones técnicas

VISUALIZACIÓN	DMNI63CF	DMNI64CF	DMNI65CF	DMNI66CF
Altura de carácter (cm)	6			
Nº dígitos	3	4	5	6
Ancho del trazo (nº LEDS)	1			
Área visualización (H x V) (mm)	192 x 63	264 x 63	336 x 63	408 x 63
Diámetro del LED (mm.)	3			
Color	RGB			
Distancia legibilidad (m)	25			
ELÉCTRICAS				
Microprocesador	16 bits			
Alimentación	230V AC +/- 15 % / 50hz			
Consumo máximo (W)	9	11,5	14	16,5
Temperatura de trabajo (°C)	-10°C a +45°C			
Tipo de alimentación	Fuente de alimentación conmutada incorporada en el interior			

## Comunicaciones

Los módulos de comunicación compatibles son los siguientes:

MÓDULOS OPCIONALES	
	<b>Módulo X</b> Comunicación serie RS232 o RS485.
	<b>Módulo NE</b> Comunicación Ethernet TCP/IP.
	<b>Módulo NW</b> Comunicación inalámbrica WiFi.
	<b>Módulo AN</b> 2 entradas analógicas de 0 – 10 V ó 4 - 20 mA configurables.
	<b>Módulo K4</b> 4 entradas digitales para incrementar/disminuir un contador.

PERIFERICOS	
	<b>Mando IR</b> Mando infrarrojo con un alcance máximo de unos 8 m.
	<b>Mando RF</b> Mando radiofrecuencia con un alcance máximo de unos 50 m.
	<b>Salidas relé RE</b> Podremos gestionar alarmas en el display para que se active uno o dos relés.

## Software



MP Tools (Windows): Software gratuito diseñado para ajustar los parámetros de configuración, así como la gestión de las alarmas o cambiar los valores numéricos. Para más detalle consultar el manual del MP Tools.

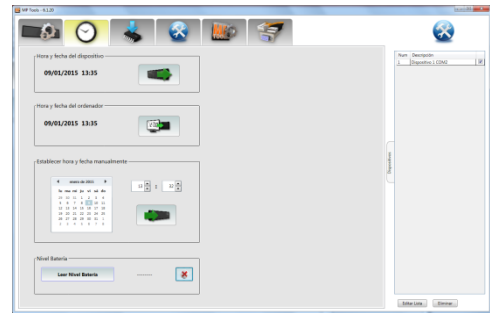

## Dimensiones

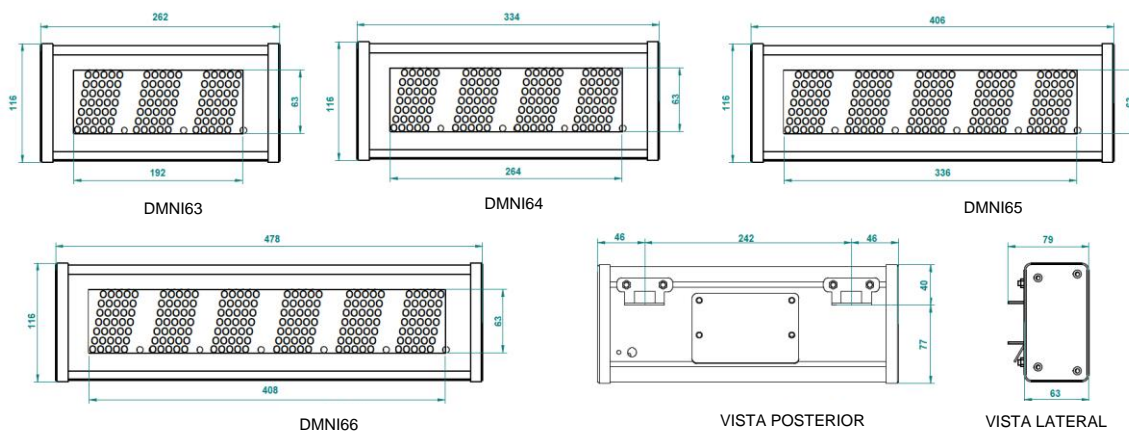

CONSTRUCTIVAS	DMNI63CF	DMNI64CF	DMNI65CF	DMNI66CF
<b>Chasis</b>				
Largo (L) x Alto (H) (mm)	262 x 116 mm	334 x 116 mm	406 x 116 mm	478 x 116 mm
Fondo (W) (mm)	63 mm. (79 mm con anclaje)			
Peso aproximado (Kg)	1,2 Kg	1,5 kg	1,8 kg	2,1 kg
Grado de protección	IP54			
Material del frontal	Metacrilato fumé			
Material del chasis	Aluminio extrusionado			
Color del chasis	Negro			
Sujeción	Mediante accesorios incluidos			

# Série DMNI6

Informations générales pour les modèles DMNI63CF, DMNI64CF, DMNI65CF et DMNI66CF.

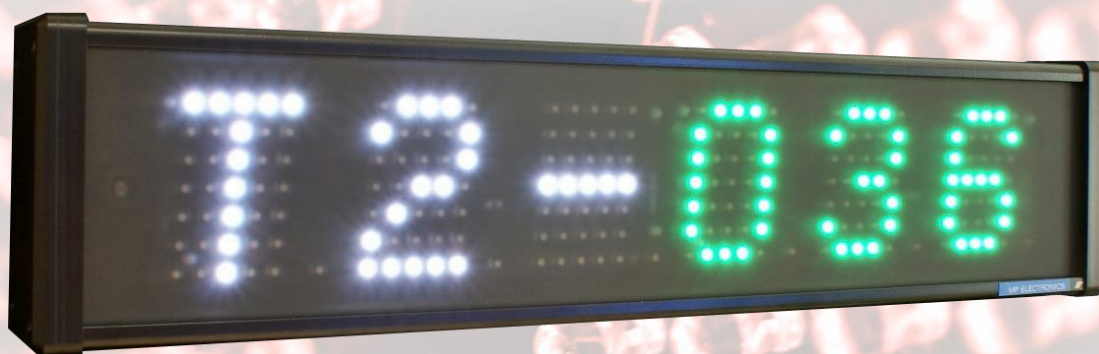

Photo DMNI66CF

## Description





- Le **DMNI6\_CF** est un produit de la série DMNI d'afficheurs numériques avec technologie RGB. Il a une hauteur de caractère de 6 cm, obtenant une distance de lisibilité maximale de 25 m.
- Les chiffres sont représentés par une matrice LED de 5 x 7 pixels pour une meilleure esthétique de visualisation.
- Les afficheurs peuvent comporter 3, 4, 5 ou 6 chiffres selon le modèle.
- Les LED RGB vous permettent de choisir entre rouge, vert, ambre, bleu, cyan, magenta et blanc.
- Il dispose d'un capteur de luminosité pour ajuster automatiquement l'intensité des LED en fonction de la luminosité.
- Conçu pour les environnements intérieurs et extérieurs.
- Communication native mini-USB.
- Il permet également de choisir un module de communication en fonction des besoins. Toutes les possibilités sont détaillées dans la section communications.
- Logiciel MPTools pour Windows. Ce logiciel nous permet d'établir des valeurs numériques, ainsi que de modifier sa configuration.
- Il est possible d'établir des seuils de couleur à l'aide du logiciel MPTools afin que la couleur soit modifiée automatiquement en fonction de la valeur qu'elle représente.
- Le châssis est fabriqué en profilé d'aluminium extrudé, garantissant une robustesse maximale de l'équipement, ainsi que son poids minimum.
- De plus, des matériaux performants sont utilisés afin de conférer au produit une grande durabilité.



## Spécifications techniques

AFFICHAGE	DMNI63CF	DMNI64CF	DMNI65CF	DMNI66CF
Hauteur des caractères (cm)	6			
N° digits	3	4	5	6
Largeur du trait (n° LEDS)	1			
Zone d'affichage (H x V) (mm)	192 x 63	264 x 63	336 x 63	408 x 63
Diamètre des LED (mm.)	3			
Couleur	RGB			
Distance de lisibilité (m)	25			
ÉLECTRIQUES				
Microprocesseur	16 bits			
Alimentation	230V AC +/- 15 % / 50hz			
Consommation maximale (W)	9	11,5	14	16,5
Température de travail (°C)	-10°C à +45°C			
Type d'alimentation	Alimentation à découpage intégrée à l'intérieur			

## Communications

Les modules de communication supportés sont les suivants:

MODULES OPTIONNELS	
	<b>Module X</b> Communication série RS232 ou RS485.
	<b>Module NE</b> Communication Ethernet TCP/IP.
	<b>Module NW</b> Communication sans fil WiFi.
	<b>Module AN</b> 2 entrées analogiques de 0 – 10 V ou 4 - 20 mA configurables.
	<b>Module K4</b> 4 entrées numériques pour incrémenter/décroître un compteur.

PÉRIPHÉRIQUES	
	<b>Commande IR</b> Commande infrarouge avec une portée maximale d'environ 8 m.
	<b>Commande RF</b> Commande radiofréquence avec une portée maximale d'environ 50 m.
	<b>Sorties relais RE</b> Nous pouvons gérer les alarmes sur l'écran afin qu'un ou deux relais soient activés.

## Logiciel



MP Tools (Windows): Logiciel gratuit conçu pour ajuster les paramètres de configuration ainsi que pour gérer les alarmes ou modifier les valeurs numériques. Pour plus de détails, consultez le manuel MP Tools.



## Dimensions

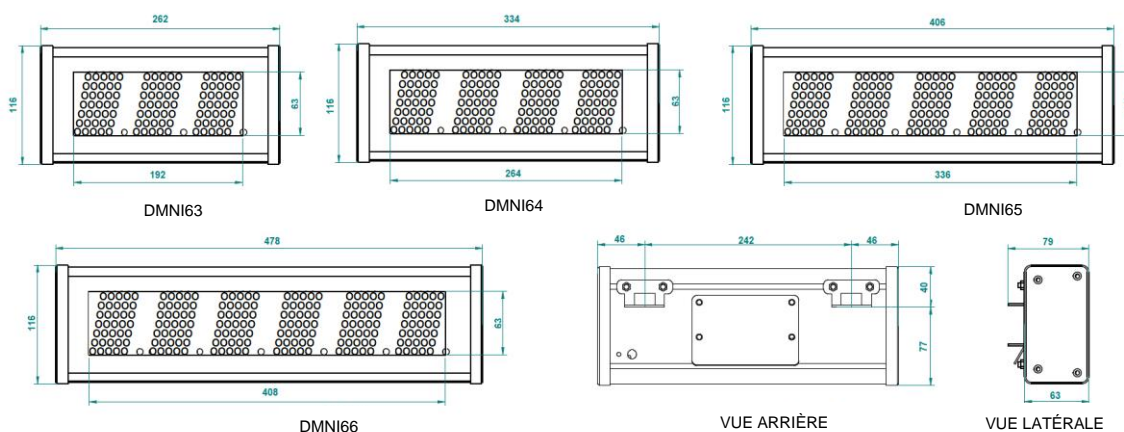

CONSTRUCTIVES	DMNI63CF	DMNI64CF	DMNI65CF	DMNI66CF
<b>Châssis</b>				
Longueur (L) x Hauteur (H)	262 x 116 mm	334 x 116 mm	406 x 116 mm	478 x 116 mm
Profondeur (W) (mm)	63 mm. (79 mm avec supports)			
Poids approx. (Kg)	1,2 Kg	1,5 kg	1,8 kg	2,1 kg
Degré de protection	IP54			
Matériau face avant	Méthacrylate fumé			
Matériau du châssis	Aluminium extrudé			
Couleur du châssis	Noir			
Fixation	Utiliser les accessoires fournis			



# DMNI6 Series

General information of the models DMNI63CF, DMNI64CF, DMNI65CF and DMNI66CF.

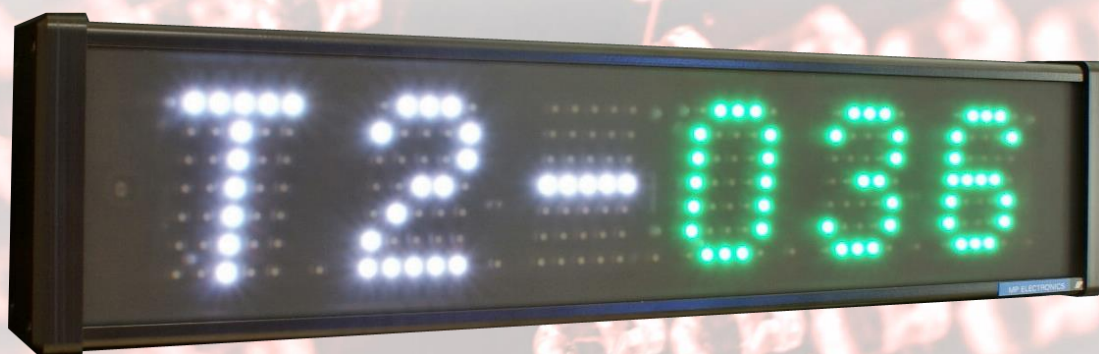

Photo DMNI66CF

## Description





- The **DMNI6\_CF** is a product of the DMNI series of numerical displays with RGB technology. It has a character height of 6 cm, obtaining a maximum readability distance of 25 m.
- The digits are represented through a 5x7 pixel LED matrix for greater viewing aesthetics.
- Displays can be 3, 4, 5 or 6 digits depending on the model.
- RGB LEDs allow you to choose between red, green, amber, blue, cyan, magenta and white.
- It has a brightness sensor to automatically adjust the intensity of the LEDs according to the brightness.
- Designed for indoor and outdoor environments.
- Native mini USB communication.
- It also allows you to choose a communication module according to needs. All the possibilities are detailed in the communications section.
- MPTools software for Windows. This software allows us to establish numerical values, as well as modify its configuration.
- It is possible to establish color thresholds using the MPTools software so that the color is modified automatically according to the value it represents.
- The chassis is manufactured using extruded aluminum profile, guaranteeing maximum robustness of the equipment, as well as its minimum weight.
- In addition, high-performance materials are used in order to give the product great durability.



## Technical specifications

DISPLAY	DMNI63CF	DMNI64CF	DMNI65CF	DMNI66CF
Character height (cm)	6			
Nº digits	3	4	5	6
Segment width (nº of LEDS)	1			
Display area (L x H) (mm)	192 x 63	264 x 63	336 x 63	408 x 63
LED diameter (mm.)	3			
Color	RGB			
Readability distance (m)	25			
ELECTRICAL				
Microprocessor	16 bits			
Power Supply	230V AC +/- 15 % / 50hz			
Maximum consumption (W)	9	11,5	14	16,5
Operating temperature (°C)	-10°C to +45°C			
Power supply type	Switching power supply built inside			

## Communications

The supported communication modules are the following:

OPTIONAL MODULES	
	<b>Module X</b> RS232 or RS485 serial communication.
	<b>Module NE</b> Ethernet TCP/IP communication.
	<b>Module NW</b> WiFi wireless communication.
	<b>Module AN</b> 2 configurable 0 – 10 V or 4 – 20 mA analog inputs.
	<b>Module K4</b> 4 digital inputs to increment/decrement a counter.

PERIPHERALS	
	<b>IR command</b> Infrared control with a maximum range of about 8 m.
	<b>RF command</b> Radio frequency control with a maximum range of about 50 m.
	<b>RE relay outputs</b> We can manage alarms on the display so that one or two relays are activated.

## Software



MP Tools (Windows): Free software designed to adjust configuration parameters, as well as manage alarms or change numerical values. For more details consult the MP Tools manual.



## Dimensions

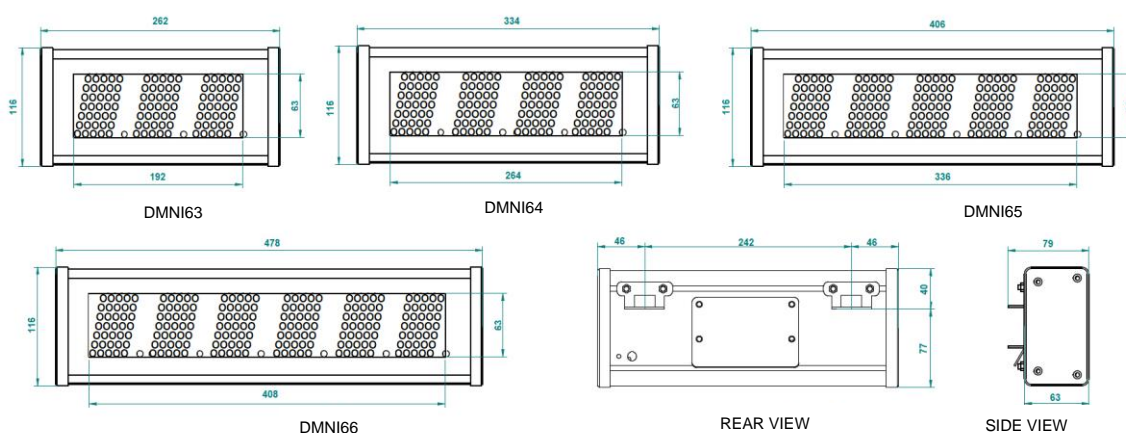

CONSTRUCTIVES	DMNI63CF	DMNI64CF	DMNI65CF	DMNI66CF
<b>Chassis</b>				
Length (L) x Height (H) (mm)	262 x 116 mm	334 x 116 mm	406 x 116 mm	478 x 116 mm
Width (W) (mm)	63 mm. (79 mm with supports)			
Approximate weight (Kg)	1,2 Kg	1,5 kg	1,8 kg	2,1 kg
Degree of protection	IP54			
Front material	Smoke methacrylate			
Chassis material	Extruded aluminum			
Chassis color	Black			
Fixation	Using included accessories			