



DISEÑOS Y TECNOLOGIA S.A.

Xarol, 6B P.I. Les Guixeres

08915 BADALONA

ESPAÑA

T: +34 933 394 758 F: +34 934 903 145 mail: dtl@ditel.es

www.ditel.es

SW series Digital Temperature Controller

SW49/SW96

TENCHNICAL MANUAL MT-SW49_SW96_EN_191007

30727592

Thank you for purchasing the DITEL module type temperature controller. Once you have confirmed that this is the product you ordered, please use it in accordance with the following instructions.

For detailed information on operating this equipment, please refer to the separate user's manual. In addition, please keep this instruction manual within easy reach of the actual person using this equipment.

CAUTION

The contents of this manual are subject to change without notice. This manual is compiled with possible care for the purpose of accuracy, however, DITEL shall not be held liable for any damages, including indirect damage, caused by typographical errors, absence of information or use of information in this manual.

Confirming Specifications and Accessories

Before using the product, confirm that it matches the type ordered. (For model code, please refer to pages 22 - 23.) Confirm that all of the following accessories are included.

Temperature Controller	1 unit
Instruction Manual	1 copy
Panel mounting adapter	2 pc
Waterproof packing	1 pc

Option	Name	Quantity	Order No.
Terminal cover*		1 pc	14000216
PC loader communication cable		1 cable	ZZP*TD501923C3
Shunt resistor (250Ω ± 0.1%)		1 pc	40800032

*For SW96, two terminal covers are necessary for one unit.

Related Information

Refer to the following reference materials for details about the items described in this manual.

Document	Reference No.
Data sheet	DS-SW49_EN DS-SW96_EN
Micro Controller (Model: SW) Operation Manual	MT-SW49_SW96_EN
Micro Controller (Model: SW) Communication Functions Manual (MODBUS)	MT-SW_COM

The latest manuals can also be downloaded at the following URL: <http://www.ditel.es>

Please Read First (Safety Warnings)

Please read this section thoroughly before using and observe the mentioned safety warnings fully. Safety warnings are categorized as "Warning" or "Caution". Failure to follow the instructions may result in a safety hazard.

Warning	mishandling may lead to minor or serious personal injury, fire, and/or property damage.
Caution	Mishandling may cause injury to the user or property damage.

If the equipment is used in a manner not specified by the manufacturer, the protection provided by the equipment may be impaired.

1. Warning

1-1. Limitations in Use

This product is a temperature controller which was developed, designed and manufactured on the premise that it would be used for general machinery. In particular, if this product is to be used for applications that require the utmost safety as described below, please take into consideration of the safety of the entire system and the machine by adopting such means as a fail-safe design, a redundancy design as well as the conducting of periodical inspections.

- Safety devices for the purpose of protecting the human body
- Direct control of transportation equipment
- Airplanes
- Space equipment
- Atomic equipment, etc.

Please do not use this product for applications which directly involve human lives.

1-2. Installation and Wiring

This equipment is intended to be used under the following conditions.

Ambient temperature	-10 °C to 50 °C	
Ambient humidity	90% RH or below (with no condensation)	
Overvoltage category	II	by IEC 61010-1
Pollution degree	2	
Recommended fuse	250VAC, 0.1A T(Time-Lag) for 100 to 240V AC Power supply, 400V DC/400V AC, 1A T(Time-Lag) for 24V DC/24V AC Power supply	
Usage environment	Indoor use	

- ▶ If accessible Safety Extra Low Voltage (SELV) circuits are to be connected to Signal input terminal, SSR Drive output terminal, Current output terminal or Communication (RS485) terminal, ensure to provide a basic insulation between the SELV circuits and these terminals (For example, use transformer which has a basic insulation or higher degree of insulation). The basic insulation requires a clearance at least 1.5 mm and a creepage of at least 3.0 mm. If such insulation is not provided, the UL61010 and EN61010 safety compliance may become invalid.
- ▶ For 24V DC/AC power supply model, if the equipment is connected to the Safety Extra Low Voltage (SELV) circuit, a basic insulation must be provided between the SELV circuit and the power input terminals. Otherwise, the power input terminals must be connect to Extra Low Voltage (ELV) circuit so as to prevent the electric shock.
- ▶ For CT input, use Current Transfer which has specification as shown below in order to prevent the electric shock and spread of fire.

1) Over Voltage Category	II
2) Pollution Degree	2
3) Required level of Insulating	BASIC INSULATION, SUPPLYMENTARY INSULATION, or REINFORCED INSULATION
4) Maximum Voltage line to neutral	300Vac rms or 300Vdc

About safety standard

Please observe the following instructions to meet the requirements of safety standard. Failure to observe these instructions violates safety standards. (This product is not a safety equipment.)

- Install a recommended fuse, which is specified in the instruction manual, between the external main power (mains circuit) and this equipment.
- If accessible Safety Extra Low Voltage (SELV) circuits are to be connected to Signal input terminal, SSR Drive output terminal, Current output terminal or Communication (RS485) terminal, ensure to provide a basic insulation between the SELV circuits and these terminals (For example, use transformer which has a basic insulation or higher degree of insulation). The basic insulation requires a clearance at least 1.5 mm and a creepage of at least 3.0 mm. If such insulation is not provided, the UL61010 and EN61010 safety compliance may become invalid.
- Whole this equipment must be mounted in an enclosure in order to prevent the electric shock and spread of fire.
- Be sure to install an appropriate external protective circuit to prevent excessive temperature rise etc.
- When performing wiring work, be sure to turn the power off and to wear protection gloves or safety glasses, to prevent an electric shock.
- Set proper parameter input signals which correspond to each input to be connected. Be careful not to confuse voltage input with current input, or vice versa.
- Do not use this equipment for the measurement of circuits which falls under measurement categories II, III, or IV.
- Do not use this equipment for measurement of signals to which a voltage over 30 VRMS or over 60 V DC is applied.
- If there is a risk that anyone may come into contact with the terminal while the instrument is being energized, attach the terminal cover (optional) to prevent an electric shock. Before removing a terminal cover, turn off all the power.

Note that the insulation class for this equipment is as follows. Before installing, please confirm that the insulation class for equipment meets usage requirements.

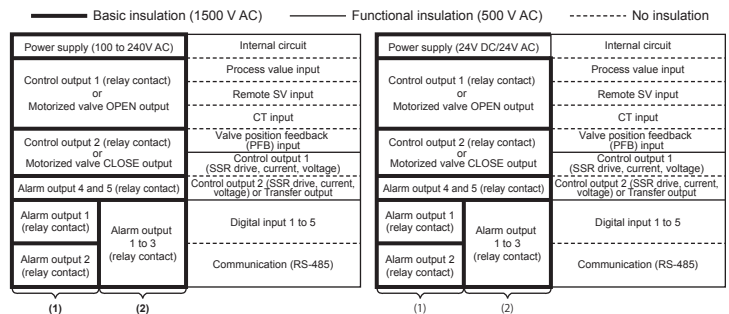

- (1): When the C code is "4" AL 1 and 2: independent common
- (2): When the C code is other than "4" AL 1 to 3: shared common

- A power switch or a circuit breaker should be installed within the power supply facility.
 - A power switch or a circuit breaker should be properly installed within easy reach of an operator.
 - A power switch or a circuit breaker should be identified as the one for this product.
 - Electrical wiring must be made by the qualified personnel only and in accordance with your local and national standards.
 - For power supply wiring, use wire equal to 600V vinyl insulated wire or above.
 - To prevent damage and failure of the equipment, provide the rated power voltage.
 - To prevent shock and equipment failure, do not turn the power ON until all wiring is complete.
 - Before turning on power, confirm that clearance space has been secured to prevent shock or fire.
 - Do not touch the terminal while the machine is on. Doing so risks shock or equipment errors.
 - Never disassemble, convert, modify or repair this equipment. Doing so risks abnormal operation, shock or fire.
 - If any failure occurs, please contact the manufacturer and return the product.
 - Output relay is the part has a limited life. When output relay contact comes to the end of its life, it might remain on-state, or off-state. For safety, use a protective circuit outside.
 - The factory default setting of this equipment is as follows. Change the setting as necessary so as the equipment to meet your application. Please note that the improper settings may result in overheat or unexpected damage.
- For the details of operation, refer to the separate volume, "Operation Manual (MG-SW49_SW96_EN)".
- Control output 1: heating control
 - Control output 2 (optional): cooling control
 - Alarm output 1 (optional): no alarm
 - Alarm output 2 (optional): no alarm
 - Alarm output 3 (optional): no alarm
 - Alarm output 4 (optional): no alarm
 - Alarm output 5 (optional): no alarm
- Symbols on the instrument
 - Read this instruction manual thoroughly before using the product, and use the product safely.

1-3. Maintenance

- When installing or removing the equipment, turn the power OFF. Otherwise, shock, operational errors or failures may be caused.
- Periodic maintenance is recommended for continuous and safe use of this equipment.
- Some parts installed on this equipment have a limited life and/or may deteriorate with age.
- The warranty period for this unit (including accessories) is three years after the date of manufacture, if the product is used properly.

2. ⚠ Caution

2-1. Cautions when Installing

Please avoid installing in the following locations.

- Locations in which the ambient temperature falls outside the range of -10 to 50°C when equipment is in use. (If the power supply is 200V AC, the recommended maximum ambient temperature is 45°C.)
- Locations with rapid temperature changes, leading to dew condensation
- Locations with corrosive gases (especially sulfide gas, ammonia, etc.) or flammable gases.
- Locations with vibration or shock directly. (Vibration and shock may cause output relay malfunction.)
- Locations in contact with water, oil, chemicals, steam or hot water.
(If the equipment gets wet, there is a risk of electric shock or fire, so have it inspected by Fuji distributor.)
- Locations with high concentrations of atmospheric dust, salt or iron particles.
- Locations with large inductive interference, resulting in static electricity, magnetic fields or noise
- Locations in direct sunlight.
- Locations that build up heat from radiant heat sources, etc.

Recommended site conditions

- A place where the ambient humidity during operation is between 45 to 85%RH.

⚠ About EMC standard

- This equipment is a class A, for industrial locations, equipment. Do not use this equipment in domestic establishments, such as residential areas, or it may cause radio interference. If you use this equipment in domestic locations, take adequate measures on the outside of the equipment to reduce radio interference.
- Under the requirement of EMC standard, the maximum length of external cable including a sensor to be connected to this equipment is 30 m. Do not connect the sensor longer than 30 m.

2-2. Cautions when Attaching to the Panels

- Please attach the SW49/SW96 with the included fixtures (2 pieces) to the top and bottom, and tighten with a screwdriver.
- The clamp torque is approximately 0.15 N/m (1.5 kg/cm)
It is designed such that overtightening will cause left/right cracking to the central area of the Fixtures and hence reduce the torque.
Cracking to the central area will not cause any problems in terms of usability of the equipment.
(However, do exercise caution in not applying too much torque because the casing is made of plastic.)
- The front of this equipment is waterproof in compliance with NEMA-4X standards (IP66- equivalent). To effect waterproof, the included packing is shall be attached between the controller and the panel according to the guidelines below. (Incorrect attachment may cause the equipment to lose its waterproof capabilities.)
(1) As shown in Fig. 1, insert to the panel after attaching the packing to the equipment case.
(2) As shown in Fig. 2, tighten the fixture screws so that no gaps can remain between the equipment face, the packing and the panels. Once finished, confirm that there are no changes in shape such as displaced or improperly-fitted packing, etc. as shown in Fig. 3.
- If the panel does not have enough strength, gaps may develop between the packing and the panel to lose waterproofing capabilities.

Fig. 1

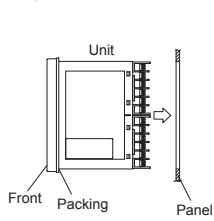

Fig. 2

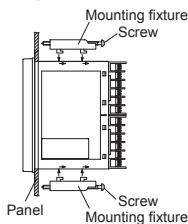
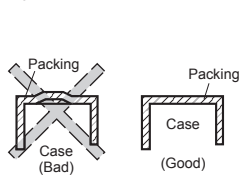

Fig. 3



Attachment on vertical surface
(Horizontal attachment)

Caution

- In order to aid heat dissipation, do not block the sides of the equipment.
- Do not block the air vents on the top and bottom of the case.

2-3. Cautions for Wiring

- For thermocouple input, use the designated compensation lead; for resistance bulb input, use wires with small lead wire resistance and without any resistance difference among the three wires.
- To avoid noise conductor effects, input signal wires should be separated from electric power lines or load lines.
- Input signal wire and output signal wire should be separated each other. And both should be shield wire.
- If there is a lot of noise from the power source, adding an insulation transducer and using a noise filter is recommended.
(Example: ZMB22R5-11, noise filter, Manufacturer: TDK)
Always attach a noise filter to a panel that is grounded securely, and keep the wiring between the noise filter output side and the measuring equipment power terminal wiring to a minimum length. Please do not attach fuses and switches, etc. to the noise filter output wiring; otherwise the filter's effectiveness will be decreased.
- Twisting the power wires is effective when connecting the wires. (The shorter the pitch of the twist, the more effective the connection is against noise.)
- Operation preparation time is required for the contact output when power is turned on. If using it as a signal to an external interlock circuit, please couple it with a delayed relay.
- Concerning the output relay, connecting the maximum rated load will shorten the product's life; so please attach an auxiliary relay. If the output operation frequency is high, selecting a SSR/SSC drive output type is recommended. [Proportionate cycles] Relay output: 30 seconds or more, SSR/SSC drive output: 1 second or more
- If you selected the version with the heater break alarm, use a common power line for the heater and the controller.
- When inductive loads such as magnetic opening/closing equipment, etc. as relay output equipment are connected, use of a surge absorber is recommended in order to protect the contacts against opening/closing surges and to ensure long-term use.

(Example)

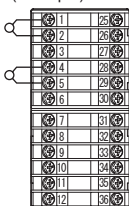

Recommended specification for the surge absorber

Voltage	Nominal varistor voltage
100 V	240 V
200 V	470 V

Attachment position: between the relay control output contacts.

2-4. Key Operation Cautions/Error Operations

- The alarm function does not work properly when an error takes place unless the settings are made correctly. Always verify its setting before operation.
- If the input wiring breaks, the display will read "UUUU". When replacing the sensor, always turn the power OFF.

2-5. Others

- Please do not wipe the equipment with organic solvents such as alcohol or benzene, etc. If wiping is necessary, use a neutral cleaning agent.
- Do not use mobile phones near this equipment (within 50 cm). Otherwise a malfunction may result.
- Trouble may occur if the equipment is used near a radio, TV, or wireless device.
- This equipment should be treated as an industrial waste when it is disposed of.

For Proper Usage

Confirmation of model code

Please confirm that the model delivered matches your order.
 "15 Model Specifications" (page 22)

1 Installation and Mounting

External dimensions
• Panel cut dimensions
• Mounting the panel
 "3 Installation and Mounting" (page 3)

2 Wiring Connection

Terminal connections diagram
 "4 Wiring" (page 4)

Turn Power On

3 Display and Operations

4 Parameter List

5 Functions of the Temperature Controller

Changing set value
 "5 Display and Operations" (page 6)
Basic Operation Methods
 "5 Display and Operations" (page 6)
Parameter List
 "6 Parameter List" (page 8 to 13)
Input/Output/Control
 "7 Functions" (page 14)

6 Advanced Usage

Setting of input sensor and input range
 "8-1 Input Setting" (page 18)
Selecting control method
 "8-3 Control Setting" (page 18)
Controlling through auto-tuning
 "7-7 Auto-tuning" (page 15)
Automatic setting parameters
 "7-3 Fuzzy PID Control", "7-4 Self-tuning Control" (page 14)

Operation

7 Error Indications

Display during equipment error
 "9 Error Indications" (page 18)

Caution

Wait 30 minutes for the controller to be stabilized thermally. Operations such as measurements should be taken after the equipment has been on for 30 minutes or more.

3. Installation and Mounting

3-1. External/Panel Cut Dimensions

SW49

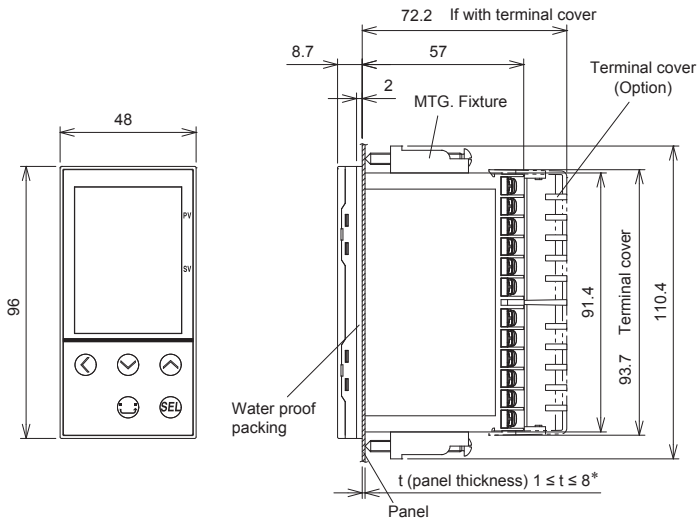

* When using the parameter loader with SW being mounted on a panel: t (panel thickness) $1 \leq t \leq 4$

SW96

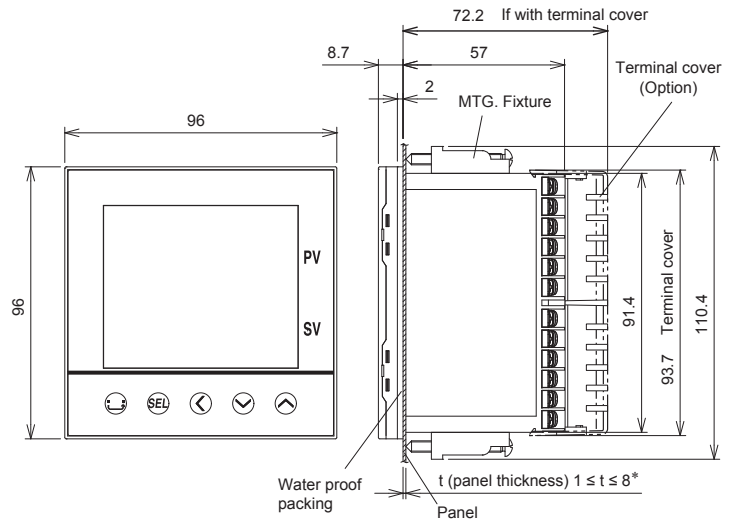

* When using the parameter loader with SW being mounted on a panel: t (panel thickness) $1 \leq t \leq 4$

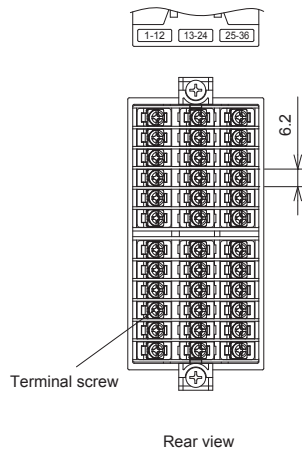

Terminal block is not attached to unused terminals (from terminal 13 to 24) depending on model.

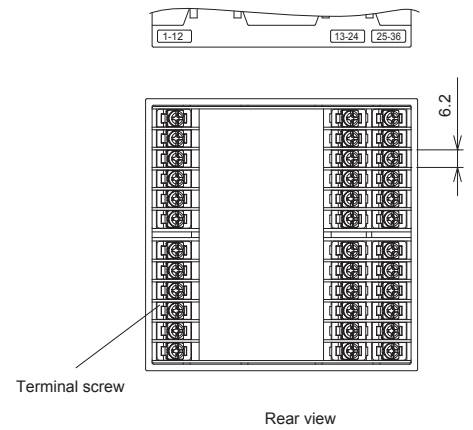

Terminal block is not attached to unused terminals (from terminal 13 to 24) depending on model.

Installing multiple controllers

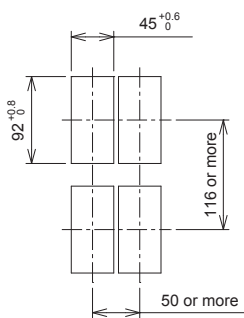

Close mounting in horizontal direction (n units)

Horizontally close mounting does not meet NEMA4X/IP66 (front waterproof specification), because packing cannot be used in this mounting.

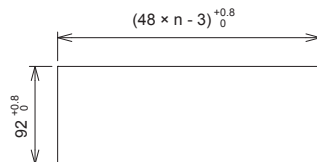

Installing multiple controllers

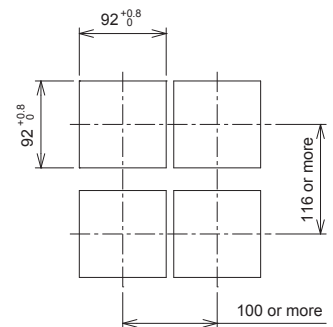

Caution

- Panel cut dimensions should also meet the above dimensions after the panel is coated.
- Cautions when Close Fit Mounting:
- When the power supply is AC 200V, keep the maximum ambient temperature at 45°C.
 - If any equipment or walls which have a depth of 70 mm exist around this instrument, keep a clearance of at least: 30 mm on the both sides, 50 mm below, 30 mm above.
- Cautions when wiring:
- Start by wiring from the left-hand terminals (terminals 1 to 12).
 - Use a screw that is the right size on terminals and tighten them with a torque of about 0.8 N/m.
 - Do not attach anything to unused terminals. (Do not use relay terminals.)

4. Wiring

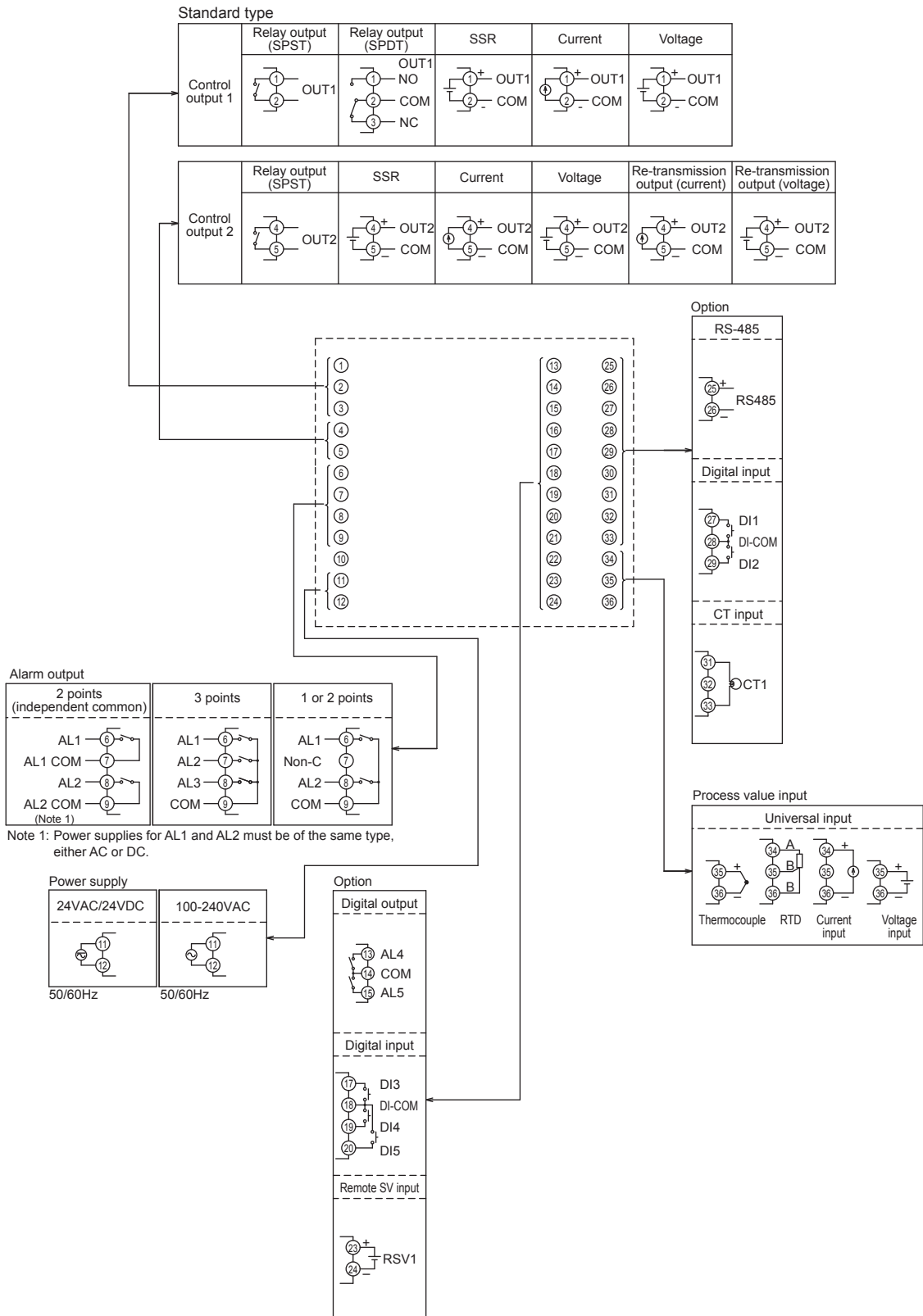

Control output 1

- Relay output (SPST)
250 V AC, 3 A (resistive load)
- Relay output (SPDT)
250 V AC, 5 A (resistive load)
- SSR output
12 V DC, 20 mA
- Current output
4 to 20 mA/0 to 20 mA (up to 500 Ω)
- Voltage output
0 to 5 V/1 to 5 V/0 to 10 V/2 to 10 V (MIN. 10 kΩ)

Control output 2

- Relay output
250 V AC, 3 A (resistive load)
- SSR output
12 V DC, 20 mA
- Current output
4 to 20 mA/0 to 20 mA (up to 500 Ω)
- Voltage output
0 to 5 V/1 to 5 V/0 to 10 V/2 to 10 V (MIN. 10 kΩ)

Alarm output 1 to 5

- Relay output
250 V DC, 1 A (resistive load)

Note) If you use SW as a substitute for SY or SZ which was used with SSR output, be careful about the control voltage of SSR, for it is different among SY, SZ, and SW.

Model	Output voltage range [V]	
	min	max
SW	10.7	13.2
SY	17.0	25.0
SZ	18.0	24.0

Note) It is not necessary to make a mistake in the wiring for the measurements input terminal. There is a possibility that the input circuit breaks when it makes a mistake in wiring.

4-1. Terminal Connection Diagram (Standard type)

4-2. Terminal Connection Diagram (Motorized valve control type)

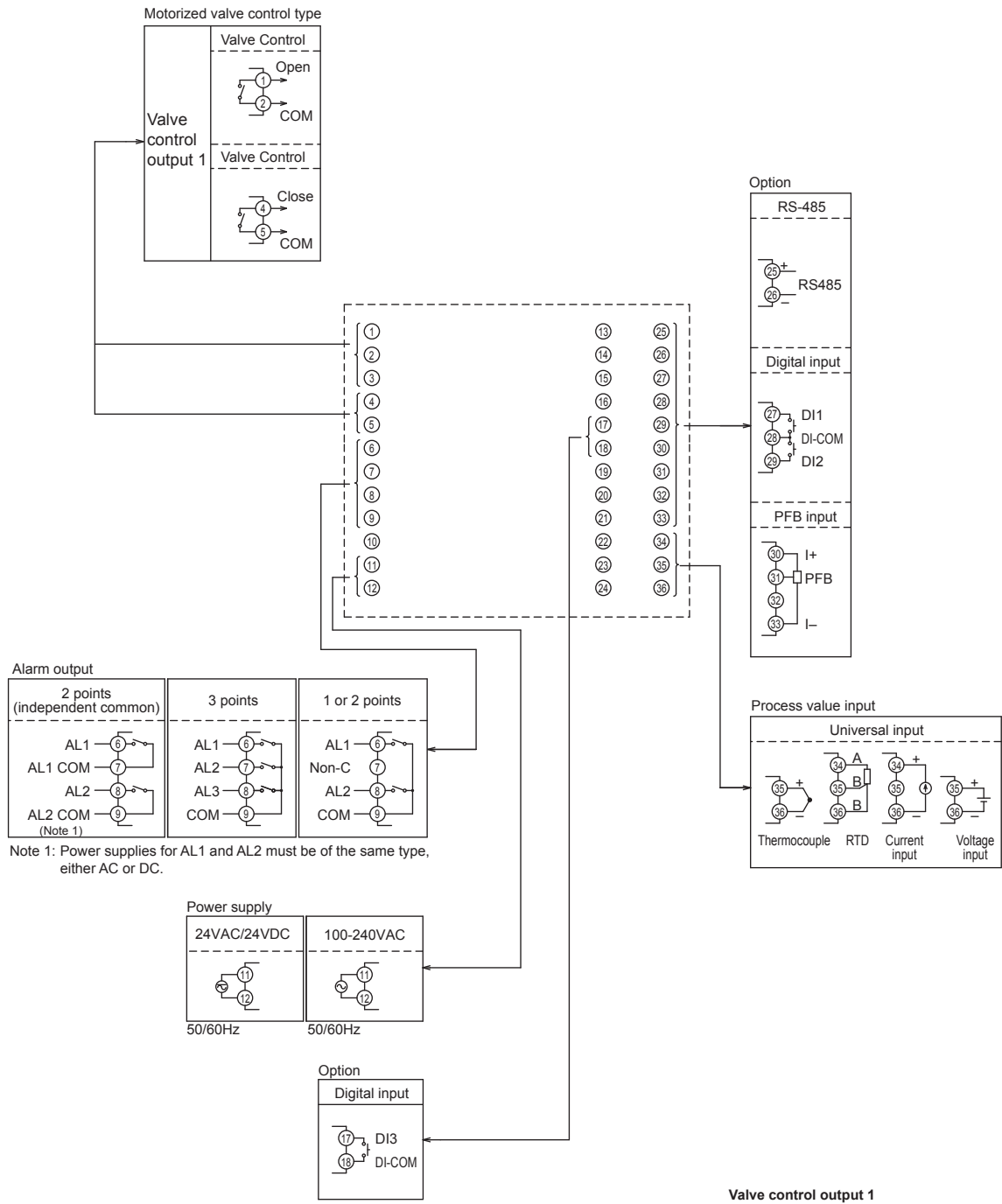

Note 1: Power supplies for AL1 and AL2 must be of the same type, either AC or DC.

- Valve control output 1**
- Relay output
 - 250 V AC, 3 A (resistive load)
- Alarm output 1 to 3**
- Relay output
 - 250 V DC, 1 A (resistive load)

5. Display and Operations

5-1. Part names and functions

Operation parts

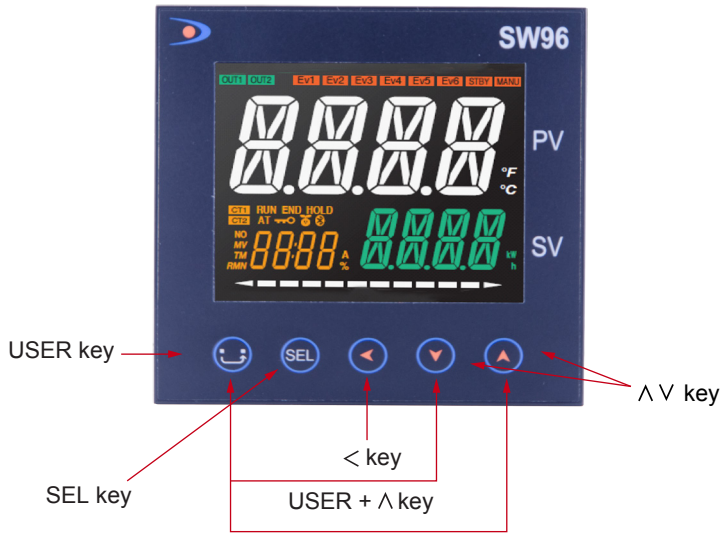

Display

SW49

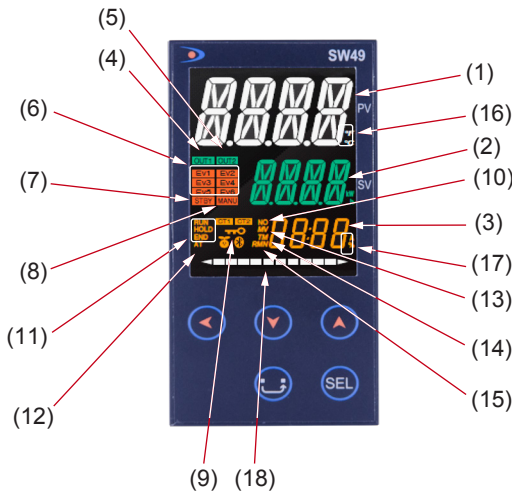

SW96

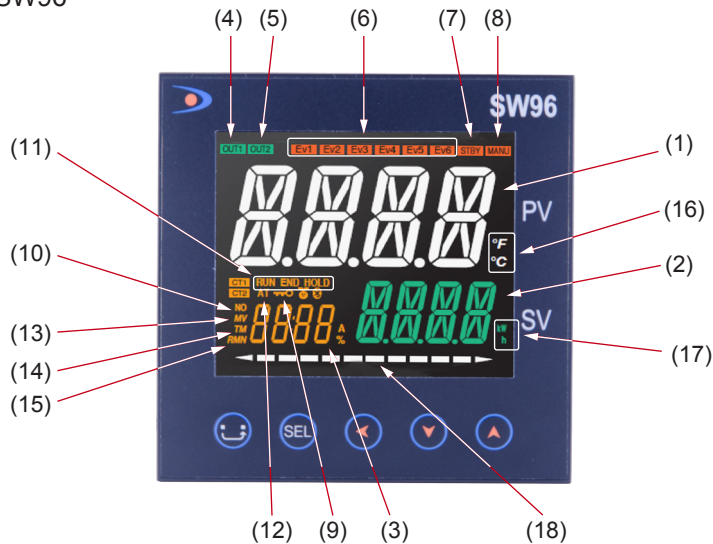

USER Key

Press this key once in PV/SV display to switch between SV display and MV display.
Press and hold this key in PV/SV display to start the assigned function.
Press this key once in operation control mode, channel-selection mode, or setup mode to return to PV/SV display.

SEL key

Press this key once in operation mode to move to operation control mode.
Press and hold this key in operation mode to move to channel selection mode.
Press this key once in channel selection mode to move to setup mode.
Press and hold this key in setup mode to move to channel selection mode.
Press this key once in parameter selection submode of setup mode to enter parameter editing submode.
Press this key once in parameter editing submode to save the change and return to parameter selection submode.

< key

Use this key to select the digit when changing values.

Δ V keys

Use this key to change SV value when in PV/SV screen.
Press this key in operation control mode, channel selection mode, or setup mode, to change parameters to be displayed.
Use this key to edit parameter when in parameter setting submode.

USER+Δ key

Press and hold this key in PV/SV display to start the assigned function.
(The factory set function for this key is switching between RUN and standby.)

USER+V key

Press and hold this key in PV/SV display to start the assigned function.
(The factory set function for this key is switching between start/stop of auto-tuning.)

(1) Process value (PV)

Indicates process value. Shows parameter name when in parameter setting.

(2) Set point (SV)

Shows set point. Shows parameter set value when in parameter setting.

(3) Screen No.

Shows screen No. when in parameter setting.

(4) OUT 1 indicator

Lights during control output 1 is ON.

(5) OUT 2 indicator

Lights during control output 2 is ON.

(6) EV 1, EV 2, EV 3 indicators

Lights during digital output 1 to 3 are ON.

(7) STBY indicator

Lights during standby.

(8) MANU indicator

Lights during manual mode.

(9) Lock indicator

Lights during key lock.

(10) No. indicator

Lights during indicating screen No.

(11) RUN/HOLD/END indicators

Lights during ramp/soak operation.

(12) AT indicator

Lights during auto tuning.

(13) MV indicator

Lights during MV is indicated on SV display.

(14) TM indicator

Lights during the time is indicated on SV display.

(15) RMN indicator

Lights during remaining time is indicated on SV display.

(16) °C/°F indicator

Shows the temperature unit under use.

(17) A%/kW/h indicator

Shows the unit under use for the values indicated on SV display.

(18) Bar graph display

Displays a bar graph of control output (MV) during operation.

5-2. Basic Operations

The below figure illustrates the mode transition and the key operations.

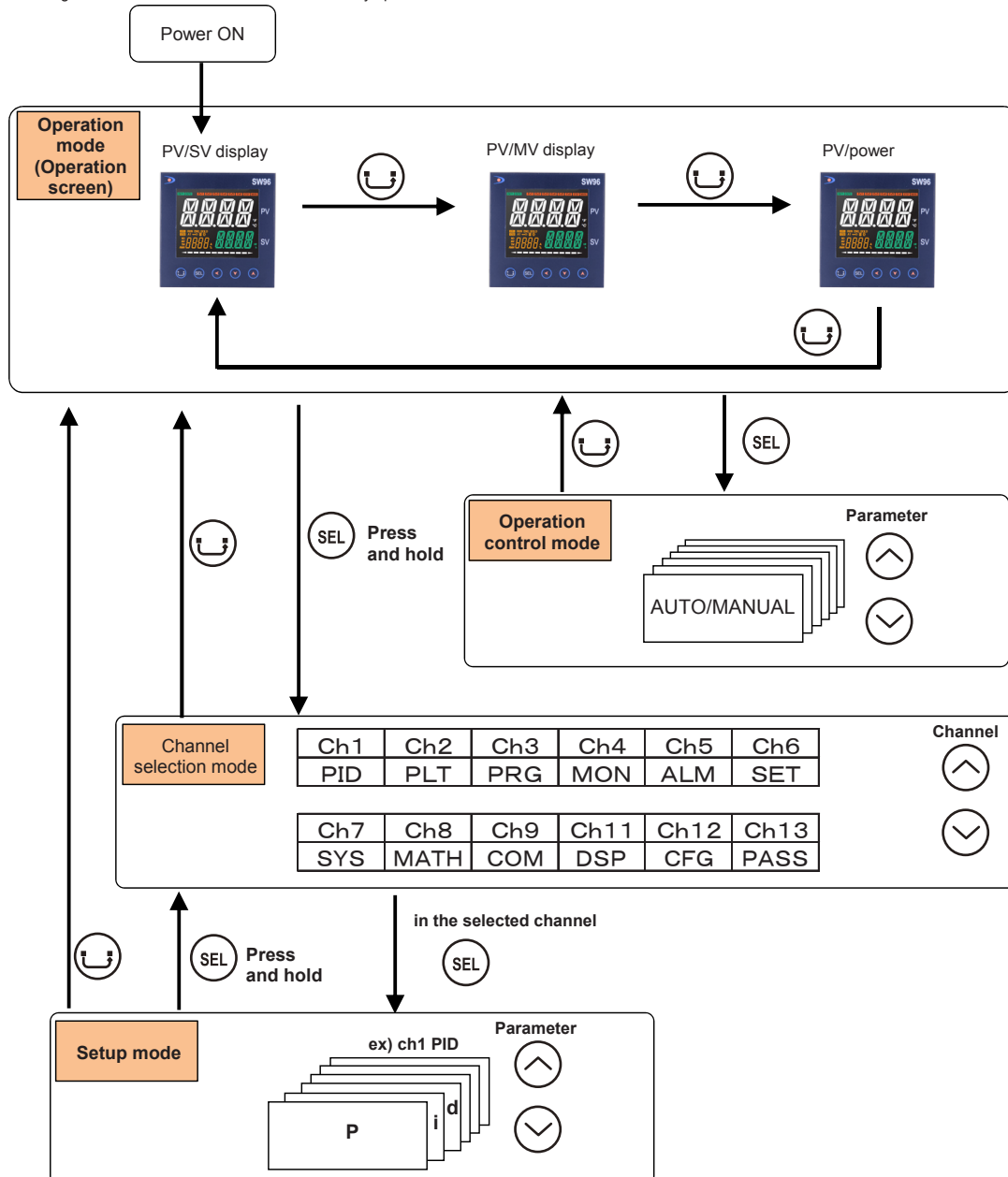

Operation mode

In this mode the normal operation is performed. The process value (PV) and the set value (SV) are displayed. The device starts in this mode when you turn on the power. You can change the set value (SV) in this mode. You can check the output value (MV) and the amount of electric power by switching in the screen.

Operation control mode

In this mode you can put the device to standby or change the alarm set value.

Channel selection mode

In this mode you can select the parameter channel to be displayed.

Setup mode

In this mode you can setup each parameter. This mode includes the parameter selection submode and the parameter editing submode, which can be switched by SEL key. In the parameter selection submode, you can switch between parameters by using Δ V keys. In the parameter editing submode, you can change parameter values by using Δ V keys.

5-3. Changing values on operation screen

- Changing SV (set values)

- 1 Change the display to PV/SV display (shown when you turn on the power and the SV lamp is lit).
- 2 Change the SV with the Δ keys.
- 3 Press the SEL key to save the values.
(The value will be automatically saved after 3 seconds even if a key is not pressed.)

- Changing MV (control output values)

- 1 Switch to manual mode.
- 2 Change the display to PV/MV display (MAN/AT/SELF lamp is lit).
(Pressing the SEL key in manual mode toggles between PV/SV display and PV/MV display.)
- 3 Change the MV with the Δ keys.

(Changes are reflected to the MV as it is changed.)

See "7-8 Manual Output" (page 15) for more about changing to manual mode.

6. Parameter List

The following explains each channel parameter.

- The list also shows the operational range of set values for parameters that are limited.
- When the PV input lower limit (PvB), PV input upper limit (PvF), or decimal place position (Pvd) is changed, reconfigure all the initial parameter setting values.
- When the parameter that has [RESET] on its Remarks column is changed, turn off the power once, and then re-start the controller.

Operation control parameter

№	Display	Parameter		Function	Setting range	Initial value	Remarks
		Name					
1	MAN	Switchover between auto and manual mode		Switchover between auto and manual modes	oFF (auto) / on(manual)	oFF	This parameter is not displayed in default setting. If you need to change this parameter, change the setting of "Ch11 dSP" so that it appears.
2	SLBY	Switchover between RUN and standby		Switchover the operation mode between RUN and standby	oFF(RUN) / on(standby)	oFF	
3	REM	Local/remote switchover		Switches the operation between local/remote SV.	LoCL (local)/ REM (remote)	LoCL	
4	PRoG	Ramp soak control command		Changes ramp soak run states	oFF (stop)/Un (run)/hLd (hold)	oFF	Displays End (when ending) or GS (during guaranty soak).
5	AL	Auto-tuning run command		Runs auto-tuning.	oFF (stop/finish) on (normal type) L-oN (low PV type)	oFF	
6	LRELH	Alarm output latch release command		Cancels the alarm output latch state	oFF / rST (latch resets)	oFF	
7	SvH	SV selection		Chooses the SV No. used for control	LoCL Sv1 Sv2 Sv3 Sv4 Sv5 Sv6 Sv7 di (depending on DI)	LoCL	"When changing the SV with the front key, do not change the "Svn" parameter via communication. Otherwise, the changed SV may not be stored correctly."
8	PLIM	PID selection		Chooses the PID No. used for control	LoCL Pid 1 (PID group No. 1) Pid 2 (PID group No. 2) Pid 3 (PID group No. 3) Pid 4 (PID group No. 4) Pid 5 (PID group No. 5) Pid 6 (PID group No. 6) Pid 7 (PID group No. 7) di (depending on DI)	LoCL	
9	AL1	ALM1 set value		Sets the alarm value for ALM1.	Absolute value alarm: 0 to 100% FS Deviation alarm: -100 to 100% FS	2.50%FS	
10	A1-L						
11	A1-H						
12	AL2	ALM2 set value		Sets the alarm value for ALM2.	Absolute value alarm: 0 to 100% FS Deviation alarm: -100 to 100% FS	2.50%FS	
13	A2-L						
14	A2-H						
15	AL3	ALM3 set value		Sets the alarm value for ALM3.	Absolute value alarm: 0 to 100% FS Deviation alarm: -100 to 100% FS	2.50%FS	
16	A3-L						
17	A3-H						
18	AL4	ALM4 set value		Sets the alarm value for ALM4.	Absolute value alarm: 0 to 100% FS Deviation alarm: -100 to 100% FS	2.50%FS	
19	A4-L						
20	A4-H						
21	AL5	ALM5 set value		Sets the alarm value for ALM5.	Absolute value alarm: 0 to 100% FS Deviation alarm: -100 to 100% FS	2.50%FS	
22	A5-L						
23	A5-H						
27	WELd	Electric power calculation command		Switches among on/off/hold of electric power calculation.	oFF (stop calculation) rUn (run calculation) hLd (suspend calculation)	oFF	
28	LoC	Key lock		Sets the key lock to prevent wrong operation	oFF (no lock) ALL (all lock) PArA (All but SV locked)	oFF	

Ch1 PID (control parameters)

№	Display	Parameter		Function	Setting range	Initial value	Remarks
		Name					
50	P	Proportional band (%)		Sets the proportional band of the PID parameter.	0.1 to 999.9%	5.0%	
51	I	Integration time		"Sets the integration time of the PID parameter. Setting "0" will turn off integration."	0 to 3200 sec	240 sec	
52	d	Differential time		"Sets the differential band of the PID parameter. Setting "0" will turn off differentiation."	0.0 to 999.9 sec	60.0 sec	
53	HYS	ON/OFF control hysteresis		Sets the hysteresis width for the ON/OFF control.	0 to 50%FS	0.25%FS	
54	CoL	Cooling proportional band coefficient		"Sets the proportional band coefficient for cooling. Setting "0.0" will turn the cooling into an ON/OFF control."	0.0 to 100.0	1.0	
55	db	Dead band (%)		Shifts the cooling proportional band from the set value	-50.0 to 50.0%	0.0%	
56	bRL	Output convergence value (%)		Offset value which is added to the MV output value	-100.0 to 100.0%	0/50 (single/dual)	
57	RR	Anti-reset windup		Sets the range of integration control	0 to 100%FS	100%FS	
58	REv	Normal/reverse operations		"Selects single control or dual control. Sets the control action (normal or reverse)."	rv- (heat (reverse)/cool (none)) no- (heat (normal)/cool (none)) rvno (heat (reverse)/cool (normal)) norv (heat (normal)/cool (reverse)) rvrv (heat (reverse)/cool (reverse)) nono (heat (normal)/cool (normal))	rv- /rvno (single/dual)	[RESET]
59	SvL	SV limit (lower)		Sets the lower limit of SV	0 to 100%FS	0.00%FS	Note 1)
60	SvH	SV limit (upper)		Sets the upper limit of SV	0 to 100%FS	100.00%FS	Note 1)
61	EL1	OUT1 proportion cycle		"Sets the proportion cycle of the control output (OUT1) (contacts, SSR drive)"	1 to 150 sec	30 (relay) 2 (SSR) 1 (current)	
62	EL2	OUT2 proportion cycle		"Sets the proportion cycle of the control output (OUT2) (contacts, SSR drive)"	1 to 150 sec	30 (relay) 2 (SSR) 1 (current)	
63	PLL1	OUT1 lower limit		Sets the lower limit of the control output(OUT1)	-5.0 to 105.0%	-5.0%	
64	PUL1	OUT1 upper limit		Sets the upper limit of the control output(OUT1)	-5.0 to 105.0%	105.0%	
65	PLL2	OUT2 lower limit		Sets the lower limit of the control output(OUT2)	-5.0 to 105.0%	-5.0%	
66	PUL2	OUT2 upper limit		Sets the upper limit of the control output(OUT2)	-5.0 to 105.0%	105.0%	
67	PUL	Type of output limiter		Sets the type of output limiter	0 to 15	0	
73	ALPA	Alpha		Sets 2-degrees-of-freedom coefficient α	-199.9 to 300.0%	40.0%	
74	BELR	Beta		Sets 2-degrees-of-freedom coefficient β	0.0 to 999.9%	100.0%	

Note 1: "SvL" and "SvH" must be set so that SvL < SvH. When you change the values for "SvL" and "SvH", check SV 1 ("Sv1 Ch2") through SV 7 ("Sv7 Ch2").

Ch2 PLT (PID palette parameters)

Parameter		Function	Setting range	Initial value	Remarks
No	Display Name				
100	SV1	Sets the SV (set value)	SV limit (lower)(SVL) to SV limit (upper)(SVH) %FS	0%FS	Note 1)
101	P1	Proportional band 1 (%)	0.1 to 999.9%	5.0%	
102	I1	Integration time 1	0 to 3200 sec	240 sec	
103	D1	Differential time 1	0.0 to 999.9 sec	60.0 sec	
104	HY51	ON/OFF control hysteresis 1	0 to 50%FS	0.25%FS	
105	CoL1	Cooling proportional band 1 (%)	0.0 to 100.0	1.0	
106	db1	Dead band 1 (%)	-50.0 to 50.0%	0.0%	
107	bRL1	Output convergence value 1 (%)	-100.0 to 100.0%	0/50 (single/dual)	
108	RR1	Anti-reset windup 1	0 to 100%FS	100%FS	
109	REV1	Normal/reverse 1	Selects single control or dual control. Sets the control action (normal or reverse).	rv-- (heat (reverse)/cool (none)) no-- (heat (normal)/cool (none)) rvno (heat (reverse)/cool (normal)) norv (heat (normal)/cool (reverse)) rvrv (heat (reverse)/cool (reverse)) nono (heat (normal)/cool (normal))	rv--/rvno (single/dual) Note 2) [RESET]
⋮	⋮	⋮	⋮	⋮	⋮
160	SV7	Sets the SV (set value)	SV limit (lower)(SVL) to SV limit (upper)(SVH) %FS	0%FS	Note 1)
161	P7	Proportional band 7 (%)	0.1 to 999.9%	5.0%	
162	I7	Integration time 7	0 to 3200 sec	240 sec	
163	D7	Differential time 7	0.0 to 999.9 sec	60.0 sec	
164	HY57	ON/OFF control hysteresis 7	0 to 50%FS	0.25%FS	
165	CoL7	Cooling proportional band 7 (%)	0.0 to 100.0	1.0	
166	db7	Dead band 7 (%)	-50.0 to 50.0%	0.0%	
167	bRL7	Output convergence value 7 (%)	-100.0 to 100.0%	0/50 (single/dual)	
168	RR7	Anti-reset windup 7	0 to 100%FS	100%FS	
169	REV7	Normal/reverse 7	Selects single control or dual control. Sets the control action (normal or reverse).	rv-- (heat (reverse)/cool (none)) no-- (heat (normal)/cool (none)) rvno (heat (reverse)/cool (normal)) norv (heat (normal)/cool (reverse)) rvrv (heat (reverse)/cool (reverse)) nono (heat (normal)/cool (normal))	rv--/rvno (single/dual) Note 2) [RESET]
170	REF1	PID switching point 1	Sets the PID switching point for palette 1.	0 to 100%FS	0%FS
⋮	⋮	⋮	⋮	⋮	⋮
176	REF7	PID switching point 7	Sets the PID switching point for palette 7.	0 to 100%FS	0%FS
177	SVMx	Max SV selection number	Choosing SV with the user key sets it to the maximum possible number.	LoCL Sv1 Sv2 Sv3 Sv4 Sv5 Sv6 Sv7 di (depending on DI)	Sv7
178	PLIM	Max PID selection number	Choosing PID with the user key sets it to the maximum possible number.	LoCL Pid1 Pid2 Pid3 Pid4 Pid5 Pid6 Pid7 di (depending on DI)	Pid7

Note 1: "SvL" and "Svh" must be set so that SvL < SvH. When you change the values for "SvL" and "Svh", check SV 1 ("Sv1 Ch2") through SV 7 ("Sv7 Ch2").
 Note 2: Set the same value as the one for the Normal/Reverse setting ("rEv Ch1").

Ch 3 PRG (ramp soak parameters)

Parameter		Function	Setting range	Initial value	Remarks	
No	Display Name					
200	REN	Ramp soak operation pattern (Step No.)	Sets which steps to use in the ramp soak operation pattern	0 (uses steps 1 to 8) 1 (uses steps 9 to 16) 2 (uses steps 17 to 24) 3 (uses steps 25 to 32) 4 (uses steps 33 to 40) 5 (uses steps 41 to 48) 6 (uses steps 49 to 56) 7 (uses steps 57 to 64) 8 (uses steps 1 to 16) 9 (uses steps 17 to 32) 10 (uses steps 33 to 48) 11 (uses steps 49 to 64) 12 (uses steps 1 to 32) 13 (uses steps 33 to 64) 14 (uses steps 1 to 64) di (depending on DI)	14	Note 1)
201	ELMU	Ramp soak time units	Sets the units of the ramp soak time	hh MM (hour:min) MM SS (min:sec)	hh.MM	
202	SV-1	Ramp soak 1 seg/SV 1	Sets the SV	0 to 100%FS	0%FS	
203	EM1R	Ramp soak 1 seg ramp time	Sets the ramp time.	00:00 to 99:59 (hour:min:min:sec)	00:00	
204	EM1S	Ramp soak 1 seg soak time	Sets the soak time.	00:00 to 99:59 (hour:min:min:sec)	00:00	
205	SV-2	Ramp soak 2 seg/SV 2	Sets the SV	0 to 100%FS	0%FS	
206	EM2R	Ramp soak 2 seg ramp time	Sets the ramp time.	00:00 to 99:59 (hour:min:min:sec)	00:00	
⋮	⋮	⋮	⋮	⋮	⋮	⋮
389	EB3R	Ramp soak 63 seg ramp time	Sets the ramp time.	00:00 to 99:59 (hour:min:min:sec)	00:00	
390	EB3S	Ramp soak 63 seg soak time	Sets the soak time.	00:00 to 99:59 (hour:min:min:sec)	00:00	
391	SV64	Ramp soak 64 seg/SV 64	Sets the SV	0 to 100%FS	0%FS	
392	EB4R	Ramp soak 64 seg ramp time	Sets the ramp time.	00:00 to 99:59 (hour:min:min:sec)	00:00	
393	EB4S	Ramp soak 64 seg soak time	Sets the soak time.	00:00 to 99:59 (hour:min:min:sec)	00:00	
394	Mod	Ramp soak mode	Sets the program operation method	0 to 15	0	
395	GSOH	Guaranty soak ON/OFF	Sets the guaranty soak ON or OFF	oFF (guaranty soak off) on (guaranty soak on)	oFF	
396	GS-L	Guaranty soak band (Lower)	Sets the lower limit of guaranty soak	0 to 50%FS	1.25%FS	
397	GS-H	Guaranty soak band (Upper)	Sets the upper limit of guaranty soak	0 to 50%FS	1.25%FS	
398	PVSt	PV start	Sets whether or not to start ramp soak with PV.	oFF (PV start off) on (PV start on)	oFF	
399	CoNL	Restore mode	Sets how to restart when the controller is restored after a power loss.	rES (Reset) Con (Continue) ini (Restart)	rES	
400	PLMH	Max pattern selection	Sets the maximum pattern number selectable by using the user key.	0 to 14	14	
401	PLMH	Min pattern selection	Sets the minimum pattern number selectable by using the user key.	0 to 14	0	

Note 1: Do not change this parameter during the ramp soak operation. Be sure to set "PrG" = "oFF" before changing the parameter.

Ch 4 MON (monitor parameters)

Parameter		Function	Setting range	Initial value	Remarks	
No	Display Name					
420	SLRL	Ramp soak progress	Displays the progress of the ramp soak	oFF (ramp soak stopped) 1-P (ramp in step 1) 1-Sk (soak in step 1) 64rP (ramp in step 64) 64Sk (soak in step 64) End (ramp soak finished)	—	
421	MV1	MV1(%)	Displays the output value of the control output (OUT1)	-5.0 to 105.0%	—	
422	MV2	MV2(%)	Displays the output value of the control output (OUT2)	-5.0 to 105.0%	—	
424	RSV	Remote SV	Shows a remote SV.	-5% to 105%FS	—	
425	IL1	Heater current (A)	Shows a heater current value. (A current value when OUT1 is ON.)	0 to 110.0 A	—	
427	LL1	SSR leak current (A)	Shows a leak current value. (A current value when OUT1 is OFF.)	0 to 110.0 A	—	
429	EM1	Remaining time on timer 1	Displays the remaining time on timer 1	0 to 9999 sec/ 0 to 9999 min	—	
430	EM2	Remaining time on timer 2	Displays the remaining time on timer 2	0 to 9999 sec/ 0 to 9999 min	—	
431	EM3	Remaining time on timer 3	Displays the remaining time on timer 3	0 to 9999 s/0 to 9999 min	—	
435	COMM	Communication status	Displays the communication status.	0 to 9999 times (number of communication times)	—	
436	CUR1	Current (A)	Shows a value measured by CT.	0 to 110.0 A	—	
438	POH	Electric power	Shows a calculated value for electric power.	0.0 to 9999 KW	—	
439	WHH	Power	Displays the calculated amount of electric power.	0.0 to 999.9 Wh	—	
440	RCH1	Number of operating times (control relay 1)	Displays the number of times that control relay 1 has operated.	0 to 9999k times	—	
441	RCH2	Number of operating times (control relay 2)	Displays the number of times that control relay 2 has operated.	0 to 9999k times	—	
442	RUNT	Operating days	Displays the number of days operated, converted from total operating time.	0 to 5000 days	—	
443	FRLT	Error source	Displays the source of an error	0 bit: PV input underflow (LLLL) 1 bit: PV input overflow (UUUU) 2 bit: PV underrange 3 bit: PV overrange 4 bit: R-SV underrange 5 bit: R-SV overrange 6 bit: Range setting error 8 bit: PV input circuit error 9 bit: R-SV input circuit error 10 bit: CT input circuit error	—	
444	DL	DI input state	Displays the state of DI.	0 bit: DI1 1 bit: DI2 2 bit: DI3	—	
445	EPSL	Communication error station number	Shows the station number under a cooperative communication error or a programless communication error.	1 to 31	—	
446	PLNO	Current palette No.	Displays the PID palette No. currently selected.	0-7	—	
447	PLNO	Current pattern No.	Displays the pattern No. of the ramp soak currently selected.	0-15	—	

Ch 5 ALM (alarm parameters)

Parameter		Function	Setting range	Initial value	Remarks	
No	Display Name					
470	ALP	ALM1 alarm type	Set the alarm type for ALM1.	0 to 58	0	Refer to section 11 for the detail.
471	AHY	ALM1 hysteresis	Sets the hysteresis for alarm output 1 ON/OFF	0 to 50%FS	0.25%FS	
472	ALY1	ALM1 delay	Sets the delay before detecting alarm output 1	0 to 9999 [sec/min]	0	
473	ALU1	ALM1 delay time units	Sets the delay time units for alarm output 1	sec (second) Min (minute)	sec	
474	AOP1	ALM1 option	Assigns the optional functions to ALM1 Ones digit: alarm output latch Tens digit: error alarm Hundreds digit: inverted output Thousands digit: hold reset	0000 to 1111	0000	
⋮	⋮	⋮	⋮	⋮	⋮	⋮
490	AL5P	ALM5 hysteresis	Sets the hysteresis for alarm output 5 ON/OFF.	0 to 50%FS	0.25%FS	Refer to Section 11 for the detail.
491	AHY5	ALM5 delay	Sets the delay before detecting alarm output 5.	0 to 9999 [sec/min]	0	
492	ALY5	ALM5 delay time unit	Sets the delay time unit for alarm output 5.	sec (second) Min (minute)	sec	
493	ALU5	ALM5 option	Assigns the optional functions to ALM5. Ones digit: alarm output latch Tens digit: error alarm Hundreds digit: inverted output Thousands digit: hold reset	0000 to 1111	0000	
494	AOP5	ALM5 option	Assigns the optional functions to ALM5 Ones digit: alarm output latch Tens digit: error alarm Hundreds digit: inverted output Thousands digit: hold reset	0000 to 1111	0000	
500	HB1	HB alarm set value	Sets the value to activate the heater burnout alarm.	0.0 to 100.0 (A)	0.0A	
501	HBH	HB alarm hysteresis	Sets an ON/OFF hysteresis for the heater burnout alarm.	0.0 to 100.0 (A)	0.5A	
502	HS1	Shorted-load alarm set value	Sets the alarm value for heater shorted load.	0.0 to 100.0 (A)	0.0A	
503	HSH	Shorted-load alarm hysteresis	Sets an ON/OFF hysteresis for the heater shorted-load alarm.	0.0 to 100.0 (A)	0.5A	
508	LBTM	Loop break detection time	Sets the time before detecting a broken loop	0 to 9999 sec	0 (Off)	
509	LBRB	Loop break detection range (°C)	Sets the temperature range before detecting a broken loop	0.0 to 100.0%FS	2.50%FS	
511	WHAL	Electricity alarm	Sets the value for electricity alarm.	0-9999KWh	0	

CH 6 SET (setup parameters)

Parameter		Function	Setting range	Initial value	Remarks	
No	Display Name					
530	PV \bar{L}	PV input type	Sets the type of input sensor	JPT1: 0.0 to 150.0°C JPT2: 0.0 to 300.0°C JPT3: 0.0 to 500.0°C JPT4: 0.0 to 600.0°C JPT5: -50.0 to 100.0°C JPT6: -100.0 to 200.0°C JPT7: -199.9 to 600.0°C PT1: 0.0 to 150.0°C PT2: 0.0 to 300.0°C PT3: 0.0 to 500.0°C PT4: 0.0 to 600.0°C PT5: -50.0 to 100.0°C PT6: -100.0 to 200.0°C PT7: -199.9 to 600.0°C PT8: -200 to 850°C J1: 0.0 to 400.0°C J2: -20.0 to 400.0°C J3: 0.0 to 800.0°C J4: -100 to 1000°C K1: 0 to 400°C K2: -20.0 to 500.0°C K3: 0.0 to 800.0°C K4: -200 to 1300°C R: 0 to 1700°C B: 0 to 1800°C S: 0 to 1700°C T1: -199.9 to 200.0°C PT2: -199.9 to 400.0°C E1: 0.0 to 740.0°C E2: -150.0 to 740.0°C E3: -200 to 740°C L: -100 to 850°C U1: -199.9 to 400.0°C U2: -200 to 400°C N: -200 to 1300°C W: 0 to 2300°C PL-2: 0 to 1300°C 0-5 V: 0 to 5 V 1-5 V: 1 to 5 V 0-10: 0 to 10 V 2-10: 2 to 10 V MV: 0 to 100 mV 0-20: 0 to 20 mA 4-20: 4 to 20 mA	K1	[RESET] Refer to section 10 for the detail.
531	PV \bar{b}	PV input lower limit	Sets the lower limit of PV input	-1999 to 9999	0	[RESET]
532	PV \bar{F}	PV input upper limit	Sets the upper limit of PV input	-1999 to 9999	400	[RESET]
533	PV \bar{d}	Decimal point position	Sets the decimal point position for the PV/SV	0: No digit after decimal point 1: 1 digit after decimal point 2: 2 digit after decimal point 3: 3 digit after decimal point	0	[RESET]
535	$\bar{L}\bar{U}\bar{L}$	Square-root extractor cut point	Sets the cut point for square root calculation.	-0.1 to 105.0(%)	-0.1%	
536	PV $\bar{o}\bar{F}$	PV input shift	Sets the amount of shift for PV input	-10 to 10%FS	0.00%FS	
538	$\bar{L}\bar{F}$	PV input filter	Sets the time constant for the PV input filter	0.0 to 120.0 sec	5.0 sec	
543	RE $\bar{M}\bar{o}$	Remote SV zero adjustment	Adjusts the zero side of remote SV.	-50 to 50%FS	0.00%FS	
544	RE $\bar{M}\bar{s}$	Remote SV span adjustment	Adjusts the span side of remote SV.	-50 to 50%FS	0.00%FS	
545	RE $\bar{M}\bar{R}$	Remote SV input range	Sets the range for remote SV input.	0-5v: 0 to 5 V 1-5v: 1 to 5 V 0-10: 0 to 10 V 2-10: 2 to 10 V	1-5V	
546	R $\bar{L}\bar{F}$	Remote SV input filter	Sets the time constant for the RSV input filter	0.0 to 120.0 s	0.0 s	
547	$\bar{L}\bar{I}\bar{R}$	OUT1 range	Sets the range of the control output 1(OUT1)	0-5v: 0 to 5 V 1-5v: 1 to 5 V 0-10: 0 to 10 V 2-10: 2 to 10 V 0-20: 0 to 20 mA 4-20: 4 to 20 mA	0-10 (voltage) 4-20 (current)	Displayed when OUT1 is current or voltage output.
548	$\bar{L}\bar{I}\bar{R}$	OUT2 range	Sets the range of the control output 2(OUT2)	0-5v: 0 to 5 V 1-5v: 1 to 5 V 0-10: 0 to 10 V 2-10: 2 to 10 V 0-20: 0 to 20 mA 4-20: 4 to 20 mA	0-10 (voltage) 4-20 (current)	Displayed when OUT2 is current or voltage output.
549	F $\bar{L}\bar{o}\bar{I}$	MV1 during FALT	Sets the output value for the control output (MV1) during FALT	-5.0 to 105.0%	-5.0%	
550	F $\bar{L}\bar{o}\bar{O}$	MV2 during FALT	Sets the output value for the control output (MV2) during FALT	-5.0 to 105.0%	-5.0%	
551	S $\bar{F}\bar{o}\bar{I}$	MV1 during Soft Start	Sets the value for the control output (MV1) during soft start	-5.0 to 105.0%	105.0%	
553	S $\bar{F}\bar{L}\bar{M}$	Soft Start set time	Sets the time from startup to the finish of soft start	00:00 to 99:59 (hour:min)	00:00	Be sure to set 0.00 during dual control.
554	S $\bar{b}\bar{o}\bar{I}$	MV1 during standby	Sets the value for the control output (MV1) during standby	-5.0 to 105.0%	-5.0%	
555	S $\bar{b}\bar{o}\bar{O}$	MV2 during standby	Sets the value for the control output (MV2) during standby	-5.0 to 105.0%	-5.0%	
556	S $\bar{b}\bar{M}\bar{d}$	Standby mode	Sets on/off of the alarm output during standby	0: ALM=OFF, AO=ON 1: ALM=ON, AO=ON 2: ALM=OFF, AO=OFF 3: ALM=ON, AO=OFF	0	[RESET]
557	R $\bar{o}\bar{L}$	AO	Selects what to transfer to the analog output.	PV SV MV DV PFb	PV	
558	R $\bar{o}\bar{L}$	AO lower scaling	Sets the AO lower scaling	-100.0 to 100.0%	0.0%	
559	R $\bar{o}\bar{H}$	AO upper scaling	Sets the AO upper scaling	-100.0 to 100.0%	100.0%	
561	V $\bar{o}\bar{L}\bar{L}$	Fixed voltage value	Sets the voltage for calculating electric power	1 to 500V	100 (100 V)	
562	$\bar{L}\bar{I}\bar{R}$	Current value for simple power calculation	Sets the current value for simple power calculation	0.0 to 100.0A	0 (0.0A)	
564	W $\bar{d}\bar{P}$	Decial point position for electric power	Sets the position of decimal point for calculated power consumption.	0 : 0 1 : 0.1 2 : 0.01 3 : 0.001	1 : 0.1	Do not change it during calculation.
565	P $\bar{H}\bar{Y}$	Power factor for simple calculation	Sets the power factor for simple calculation	0.00 to 1.00	1.00	
566	R $\bar{Y}\bar{L}\bar{N}$	Upper limit of relay contact operation	Sets the upper limit on the number of times a relay contact can operate. If you set it to 0, no alarm will be generated.	0 to 9999	100 (100K times)	
567	O $\bar{P}\bar{L}\bar{M}$	Upper limit of operating days	Sets the upper limit on the number of days the device operates. If you set it to 0, no alarm will be generated.	0 to 5000	3650 (3650 days)	

Ch 7 SYS (system parameters)

Parameter		Function	Setting range	Initial value	Remarks	
No	Display Name					
590	USER 1	USER key	Assigns the function to the [USER] key	0 to 29	0	Refer to section 12 for the detail.
591	USER 2	USER + UP key	Assigns the function to the [USER]+ Λ key	0 to 29	1	
592	USER 3	USER + DOWN key	Assigns the function to the [USER]+ V key	0 to 29	5	
593	DI 1	DI-1 function select	Allocates a function to DI-1.	0-48	0	Refer to Section 14 for the detail.
594	DI 2	DI-2 function select	Allocates a function to DI-2.	0-48	0	
595	DI 3	DI-3 function select	Allocates a function to DI-3.	0-48	0	
599	OUT 1	OUT1 output type	Selects the content to be output from OUT1	0 to 427	1	Refer to section 13 for the detail.
600	OUT 2	OUT2 output type	Selects the content to be output from OUT2	0 to 427	2	
601	DO 1	DO1 output type	Selects the content to be output from DO1.	0 to 427	3	
602	DO 2	DO2 output type	Selects the content to be output from DO2.	0 to 427	4	
603	DO 3	DO3 output type	Selects the content to be output from DO3.	0 to 427	5	
604	DO 4	DO4 output type	Selects the content to be output from DO4.	0 to 427	6	
605	DO 5	DO5 output type	Selects the content to be output from DO5.	0 to 427	7	
607	LED 1	LED indicator assignment (OUT1)	Selects the content for OUT1 to indicate.	0 to 427	1	
608	LED 2	LED indicator assignment (OUT2)	Selects the content for OUT2 to indicate.	0 to 427	2	
609	LED 1	LED indicator assignment (Ev1)	Selects the content for EV1 lamp to indicate.	0 to 427	3	
610	LED 2	LED indicator assignment (Ev2)	Selects the content for EV2 lamp to indicate.	0 to 427	4	
611	LED 3	LED indicator assignment (Ev3)	Selects the content for EV3 lamp to indicate.	0 to 427	5	
612	LED 4	LED indicator assignment (Ev4)	Selects the content for EV4 lamp to indicate.	0 to 427	6	
613	LED 5	LED indicator assignment (Ev5)	Selects the content for EV5 lamp to indicate.	0 to 427	7	
614	LED 6	LED indicator assignment (Ev6)	Selects the content for EV6 lamp to indicate.	0 to 427	0	
615	LED 6	LED indicator assignment (STBY)	Selects the content for STBY lamp to indicate.	0 to 427	12	
616	LED 6	LED indicator assignment (MANU)	Selects the content for MAN lamp to indicate.	0 to 427	13	
617	RMP	Ramp SV ON/OFF	Sets the ramp SV ON/OFF	oFF oN	ON	
618	RMP L	Ramp SV-Decline	Sets the slope for a falling SV during ramp SV operations	0 to 100%FS	0.00%FS	
619	RMP H	Ramp SV-Incline	Sets the slope for a rising SV during ramp SV operations	0 to 100%FS	0.00%FS	
620	RMP U	Ramp SV-slope time unit	Sets the unit of time for the slope during ramp SV operations	hoUr: slope temperature/hour Min: slope temperature/min	hoUr	
621	SV L	Ramp SV - display mode	Displays the SV during ramp operations or the SV goal value on the SV display	rMP: ramping SV TrG: target SV	rMP	
622	CTR L	Control method	Selects the control method.	oNoF: ON/OFF control Pid: PID control FUZY: Fuzzy control SELF: Self-tuning control Pid2: PID2 control 2FRE: 2-degrees-of-freedom PID	Pid	
623	PRCS	Valve control mechanism	Selects a valve control mechanism.	SRV1: Servo control 1 SRV2: Servo control 2 PFb: Position feedback control	SRV1 (SrV1: without PFB) PFB (PFB: with PFB)	
626	StMd	Start mode	Sets the operation mode during startup	AUTO: starts in AUTO mode MAN: starts in manual mode REM: starts in remote mode STbY: starts in standby mode	AUTO	
627	dL	Control operation cycle	Sets the control operation cycle.	0.1 to 0.9S, 1 to 99S	0.1S	
628	PL L5	PID pallette switching method	Sets the method for switching among PID pallette.	0: selected PID № 1: selected SV № 2: PV	0	

Ch 8 MATH (calculation parameters)

Parameter		Function	Setting range	Initial value	Remarks
No	Display Name				
650	MATH	Simple calculation ON/OFF	Sets ON/OFF of simple calculation	OFF ON	OFF Note 1)

Note 1: Refer to the operation manual for the detail of calculation functions.

Ch 9 COM (communication parameters)

Parameter		Function	Setting range	Initial value	Remarks
No	Display Name				
760	CTYP	Communication type	Selects a type of communication.	0: MODBUS RTU 1: Cooperative operation 2: Programless communication	0 [RESET] Note 1)
761	STNo	Station No.	Sets the station number.	0 to 255 (0: unresponsive communication)	1 [RESET]
762	SPEd	RS-485 baud rate	Sets the baud rate	96: 9600 bps 192: 19200 bps 384: 38400 bps 115K: 115 Kbps	96 [RESET]
763	PRLY	RS-485 parity	Sets the parity check	none odd even	odd [RESET]
764	CNtV	RS-485 response interval	Widen the time interval of receiving response. (Set value × 20 ms)	0 to 100	1 (20 ms) [RESET]
767	SEL	Communication permissions	Sets whether or not overwriting is possible from the master side (PC, etc.)	r: Read only rW: Read/overwrite permitted	rW [RESET]
769	UAD 1	MODBUS user address setting 1	Sets the MODBUS user address		30001 [RESET]
•	•	•	•	•	•
•	•	•	•	•	•
800	UAD 32	MODBUS user address setting 32			30001 [RESET]

Note 1: Refer to the communication instruction manual (MODBUS) for the detail of communication functions.

Ch 10 PFB (PFB parameters)

Parameter		Function	Setting range	Initial value	Remarks
No	Display Name				
870	PFB	PFB dead band	Sets the dead band for PFB.	0.0% to 100.0%	5.0%
871	VAL	Valve stroke time	Sets the full-stroke time for the motorized valve.	5 s to 180 s	30 s
873	CAL	PFB input adjustment command	Adjusts the zero/span for PFB input.	0 (none/forcibly terminate) 1 (zero adjustment) 2 (span adjustment) 3 (automatic adjustment)	—

Ch 11 DSP (parameter mask)

№	Display	Parameter		Function	Setting range	Initial value	Remarks
		Name					
—	—	Parameter mask		Sets the parameters to be displayed/not displayed.	OFF/diSP	Values differ depending on the model.	

Ch 12 CFG (configuration parameters)

№	Display	Parameter		Function	Setting range	Initial value	Remarks
		Name					
940	<i>tOUT</i>	Operation timeout (return to PV/SV display)		Sets the time until the display returns to PV/SV screen from setting screen.	15S: 15 sec 30S: 30 sec 60S: 60 sec 5M: 5 min 10M: 10 min non	60S	
942	<i>SOFF</i>	Blinking SV during Soft Start		Sets whether or not to blink SV during Soft Start.	oFF: OFF oN: ON	ON	
943	<i>ALMF</i>	Blinking PV/SV at ALM		Sets whether or not to blink PV/SV when alarm becomes ON.	0: PV display (no change) 1: PV and alarm status, alternately 2: blinking PV 3: alarm status	0	
944	<i>LOFF</i>	Display timeout		Sets the time until the display automatically turns off.	oFF: Not use 15s: Auto-off after 15 sec. 30s: Auto-off after 30 sec. 1M: Auto-off after 1 min. 5M: Auto off after 5 min.	oFF	
945	<i>dSPt</i>	PV/SV Display off		Sets ON/OFF of PV and SV display	0: PV and SV ON 1: SV OFF 2: PV OFF 3: PV and SV OFF 4: PV, SV, and indicators OFF (all OFF) 5: SV OFF (relights for 5 sec. by pressing any key) 6: PV OFF (relights for 5 sec. by pressing any key) 7: PV and SV OFF (relights for 5 sec. by pressing any key) 8: PV, SV, and indicators OFF (relights for 5 sec. by pressing any key)	0	
946	<i>FRLt</i>	Blinking PV at input error		Sets whether or not to blink PV at an input error	0: PV blinks at an input error 1: No blink	0	
947	<i>bLcL</i>	Brightness		Sets the brightness of LED backlight	0 to 3	3	(3 is the brightest)
948	<i>bLoH</i>	Control at burnout		Sets whether to continue or to stop control when the device detects a burnout of PV input	oFF: stops control oN: continues control	oFF	
950	<i>PL01</i>	Model code		Shows model code	-	P	
951	<i>PL02</i>					X	
952	<i>PL03</i>					F	
	•	•	•	•	•	•	•
	•	•	•	•	•	•	•
962	<i>PL13</i>					*	
963	<i>RSr</i>	Reset		Resets the controller	oFF: No reset rST: Performs reset	oFF	
965	<i>VER1</i>	Software version		Shows the software version	—	—	
966	<i>VER2</i>						
967	<i>VER3</i>						
968	<i>VER4</i>						

Ch 13 PASS (password parameters)

№	Display	Parameter		Function	Setting range	Initial value	Remarks
		Name					
990	<i>PAS1</i>	Password1 setup		Sets password 1.	0000 to FFFF	0000	
991	<i>PAS2</i>	Password2 setup		Sets password 2.	0000 to FFFF	0000	
992	<i>PAS3</i>	Password3 setup		Sets password 3.	0000 to FFFF	0000	

7. Functions

This controller has six types of temperature control function. Select according to type and use.

Caution The ramp soak function (□ page 15), and SV selection function (□ page 17) cannot be combined.

• Temperature Control Functions

ON/OFF (2-position) control	Turns the control output ON/OFF according to the size relationship of PV and SV. Can build a control system out of simple elements such as SSR. Suitable when accuracy is not requested.	7-1 (page 14)
PID Controls	PID calculation and controls proceed according to the previously set PID parameters. PID parameters can be set manually or through auto-tuning (AT). It is the most basic control in this equipment.	7-2 (page 14)
Fuzzy PID Control	PID control with function that reduces the amount of overshoot during control. It is effective when you want to suppress overshoot when SV is changed, even if you may take a long time to reach the target value.	7-3 (page 14)
Self-tuning Control	Automatically calculating PID control according to the control target or SV change. It is effective when the control conditions change frequently.	7-4 (page 14)
PID2 Control	In case which the power supply of the control target goes ON → OFF → ON, this PID2 control can suppress the amount of overshoot during control target turns OFF → ON.	7-5 (page 15)
2-degrees-of-freedom control	Suppresses the amount of overshoot during PID control. It uses SV filter which is effective in reducing overshoot after a SV change or at startup.	7-6 (page 15)

7-1. ON/OFF (2-position) Control

Acts as an ON/OFF control when "CLRL" = oNoF ("5Y5 [h 7]"). ON/OFF control switches the control output to ON (100%) or OFF (0%) according to the size relationship of PV and SV. The output hysteresis can be set under the parameter "HYS" ("Pcd [h 7]").

Reverse Operation (heat control)

Method used to control the electrical heating furnace. Set the "hYS" to an appropriate value according to the control target.

Parameter	Set value
"CLRL"	oNoF
"PEL"	rv--
"HYS"	arbitrary (factory setting: 1 °C)

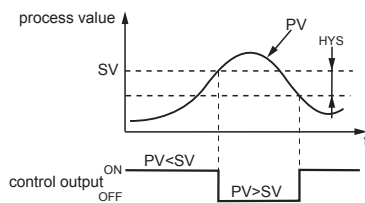

Normal Operation (cooling control)

Method used to control the cooling machine

Parameter	Set value
"CLRL"	oNoF
"PEL"	no--
"HYS"	arbitrary (factory setting: 1 °C)

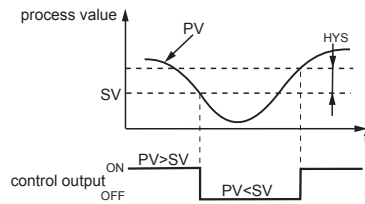

Point ■■■■

- During ON/OFF control, the P, I and D settings do not affect control.
- The manual operation during ON/OFF control will become MV=100% when the ⊙ key is pressed, and MV=0% when the ⊖ key is pressed.
- If the hysteresis width is narrow, and PV and SV are nearly equal, the output may frequently switch ON and OFF. Note that it may affect the operation life of the contact output.

7-2. PID Controls

PID controls run as long as the parameter is set to "CLRL" = Pcd ("5Y5 [h 7]"). The PID controls calculate PID based on the set values for parameters "P", "I", "d", and "RRP", and output the calculated result (-5% to 105%).

Each parameter can be set either by manually tuning the values or by running auto-tuning (AT) to automatically set the values.

Refer to For more details on auto-tuning, see "7-7 Auto-tuning" (page 15)

- 1 Display the system menu ("5Y5 [h 7]").
- 2 Display the control parameter ("CLRL") and choose PID controls ("Pcd").
- 3 Press the key to set the value.

7-3. Fuzzy PID Control

Related to normal PID controls, fuzzy PID control acts with small overshoot. You will need to run auto-tuning to set the PID parameter when using fuzzy control.

Setting fuzzy PID control

- 1 Display the system menu ("5Y5 [h 7]").
- 2 Display the control parameter ("CLRL") and choose fuzzy ("FUZY").
- 3 Press the key to set the value.

Refer to For more details on auto-tuning, see "7-7 Auto-tuning" (page 15)

7-4. Self-tuning Control

Self-tuning Control is a control which automatically calculates the value of PID, under the condition that the control target or set value (SV) changes.

Self-tuning is especially effective for situations when a high level of control is not needed, but auto-tuning cannot be run due to frequent changes in the control target conditions.

Point ■■■■ When a high level of control is required, choose PID control, fuzzy PID control, or PID2 control.

Conditions where self-tuning can be used

Self-tuning is used in the following situations:

- When temperature rises when the power is turned on
- When temperature rises when SV changes (or when the controller decides it is necessary)
- When the controller decides it is necessary because the controls have become unstable

Conditions where self-tuning cannot be used

Self-tuning cannot be used in the following situations:

- During control standby
- During auto-tuning
- During ramp soak progress
- When there is error input
- When set for dual output
- When any of the P, I, D, Ar parameters are set to manual
- During manual mode
- During soft start progress

Conditions to halt self-tuning

Halt self-tuning in the following situations:

- When there is a change in SV (This includes the case where SV changes because of the ramp soak function, remote SV function, or ramp SV.)
- When self-tuning has not finished after running for nine or more hours

Setting self-tuning

Turn on power of the controller and set the SV.

- 1 Display the system menu ("5Y5 [h 7]").
- 2 Display the controller parameter ("CLRL") and choose self-tuning ("SELF").
- 3 Press the key to set the value.
- 4 Turn off power of the controller.
- 5 Turn on power of the control target equipment and the controller. Turn on power of the control equipment first. Self-tuning will begin.
- 6

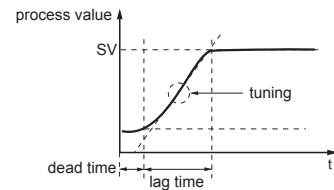

Point ■■■■

- The equipment will not tune correctly if power of the controller is turned on first.
- To reset self-tuning, set the control method to PID ("Pcd") once before changing back to self-tuning.

7-5. PID2 Control

In the case which the power supply of the control target goes ON → OFF → ON, this PID2 control can suppress the amount of overshoot. This control introduces an algorithm to prevent the calculated PID result from becoming a miscalculation, even when the control loop is open. You will need to run auto-tuning to set the PID parameter when using PID2 control.

- Features of PID2 Control

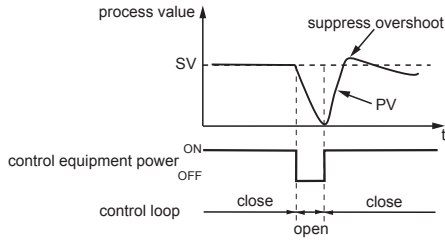

Setting PID2 control

- 1 Display the system menu ("595 [h 7]).
- 2 Display the control parameter ("LRL") and choose PID2 ("P2d").
- 3 Press the (SEL) key to set the value.

7-6. 2-Degrees-of-Freedom PID Control

Suppresses the amount of overshoot during PID control. It uses the SV filter which is effective in reducing overshoot after a SV change or at startup. Controllability in 2-degrees-of-freedom PID control is different depending on the setting of the coefficient α and β . When the coefficient $\alpha = 100.0\%$ and coefficient $\beta = 0.0\%$, the system performs the normal PID control.

You can adjust the coefficient α and β as follows:

- 1) Set the coefficient α to 40.0% and β to 100.0%. (factory default setting)
- 2) Perform a control to check the response (small overshoot).

If overshoot is not reduced by this measure, adjust the coefficient α and β in accordance with the following table.

We recommend you to fix the coefficient α to 40.0% because it usually requires no adjustment.

Control result	Coefficient β	coefficient α
Large overshoot	Raise coefficient β by 20%	Lower coefficient α by 10%
Small overshoot	Lower coefficient β by 20%	Raise coefficient α by 10%

Setting 2-degrees-of-freedom PID control

- 1 Display the system menu ("595 [h 7]).
- 2 Display the control parameter ("LRL") and choose 2-degrees-of-freedom PID ("2FRE").
- 3 Press the (SEL) key to set the value.

7-7. Auto-tuning

Run auto-tuning to set the PID parameter automatically.

"RL" set value	Behavior	Function
"OFF"	Stop/Finish	Stops or finishes auto-tuning.
"H"	Normal type	The standard auto-tuning for SV reference. Choose this auto-tuning in most situations.
"L-H"	Low PV type	Auto-tuning for SV-10% reference. Choose this when you want to suppress the overshoot when tuning.

- Normal type

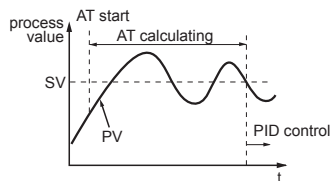

- Low PV type

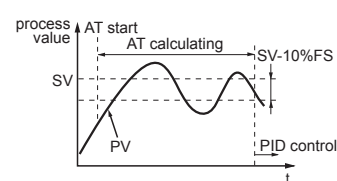

Point

- Set the following parameters before running auto-tuning.
 - PV input type / PV input upper limit / PV input lower limit / Decimal position / PV input filter in the setup channel menu ("SEt [h 6])
 - OUT1 proportion cycle (OUT2 proportion cycle) in the PID channel menu ("P2d [h 8]).

Running auto-tuning

- 1 Display auto-tuning ("RL") and choose the tuning type. Choose the standard type ("H") or low PV type ("L-H") according to the control target.
- 2 Press the (SEL) key to start auto-tuning. AT lamp point will blink at the bottom of the display during auto-tuning. When auto-tuning has successfully completed, blinking AT lamp will turn off and overwrites the PID.

Point

- PID parameter which is set after auto tuning has finished normally will be maintained even when the power is turned off. However, the PID value will not be changed if the power is turned off during auto-tuning. In this case, rerun auto-tuning.
- The equipment will use ON/OFF (2 position) control during auto-tuning, so there may be a large change in PV according to the process. Do not use auto-tuning for processes that do not permit a large change in PV. Do not use auto-tuning for processes such as pressure control and flow control that have a fast response.
- Auto-tuning is not behaving normally if it has not finished after four or more hours have passed. In these cases, recheck parameters such as input/output wiring, control output behavior (normal/reverse), and input sensor type.
- Rerun auto-tuning if there is a large change in SV, a change in the PV input type, or a change in the control target conditions that reduces the effectiveness of the controls.
- You can run auto-tuning when the control type is set to "fuzzy" or "PID2".
- You cannot run auto-tuning in manual mode.
- When using the PID selection function, the auto-tuning result for the selected PID group is stored.
- Auto tuning is forcibly terminated when SV changes because of the ramp soak function, remote SV function, or ramp SV.

7-8. Manual Output

Allows the control output to be manually set at an arbitrary value.

- Manual Mode Display
 - MV indicator lights during manual mode and during parameter setting.
- Switchover between Auto and Manual
 - Modes can be changed by three methods: the front key (user key), communication function, or the parameter "MAN".
- MV output flow diagram (MV output priority processing)

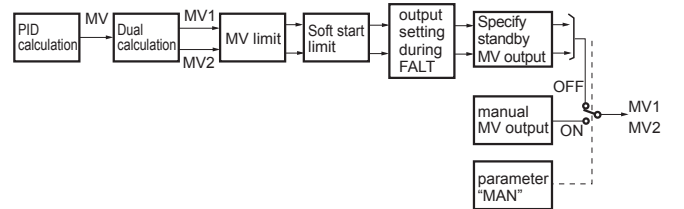

Caution

- MV limit does not apply to the MV output during manual operation, FALT, or standby. (Take extra caution when MV performs flash protection during combustion control by using the overlimit function.)

7-9. Ramp Soak Function

Automatically runs after setting the times for the SV changes.

You can choose up to 64 steps for the SV setting and 15 types of ramp soak operation patterns.

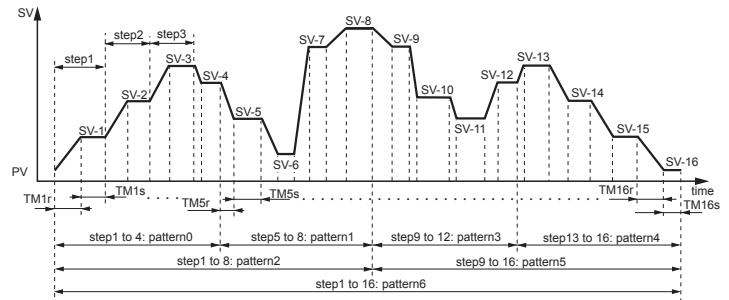

Caution

- When using the system in the restore mode ("L-H") = continue ("L-H") in the ramp/soak menu ("PRG [h 3]), do not set the ramp/soak control command ("PRG") of the operation menu to hold ("H") during the ramp period at the beginning of the pattern.
- When PV start ("PV5") of the ramp/soak menu ("PRG [h 3]) is on ("H"), set the pattern parameter ("PL") of ramp/soak ("PRG [h 3]) to "PL" = 0, 2, 6 (setting that starts with 1 seg ramp).
- Do not set the Startup mode ("StM") = standby mode ("StB") of the system menu ("595 [h 7]) and the restore mode ("L-H") = continue ("L-H") of the ramp/soak menu ("PRG [h 3]) at the same time.

Creating a ramp soak operation pattern

Set the following items to create a pattern.

Pattern	Sets which steps to use from the following 15 types. Steps 1 to 8 / Steps 9 to 16 / Steps 17 to 24 / Steps 25 to 32 / Steps 33 to 40 / Steps 41 to 48 / Steps 49 to 56 / Steps 57 to 64 / Steps 1 to 16 / Steps 17 to 32 / Steps 33 to 48 / Steps 49 to 64 / Steps 1 to 32 / Steps 33 to 64 / Steps 1 to 64
Target SV	Sets the controlled temperature.
Ramp time	Sets the time to reach the target SV from the current SV.
Soak time	Sets the time to maintain the specified SV.

The following steps will explain how to run the specified pattern 0 in SV-1 to SV-8.

- 1 Display the ramp soak menu ("PRG [h3]").
- 2 Display pattern parameter ("PLN") and choose pattern 0 ("0").
Run SV-1 through SV-8.
- 3 Display the time parameter ("LMLU") and choose minute:second ("MMSS").
Sets the units of time. Besides minute:second ("MMSS"), you can also choose hour:minute ("HHMM").
- 4 Display the target value ("SV - I") and set the target temperature.
- 5 Display the ramp time parameter ("LMI") and set the ramp time.
- 6 Display the soak time parameter ("LMS") and set the soak time.
- 7 Repeat steps 4 through 7 and set the remaining parameters.

Running ramp soak

The following steps explain how to run ramp soak.

- 1 Display program parameter ("PRG") and choose RUN ("RUN").
- 2 Ramp soak starts running from the current PV.

Point	<ul style="list-style-type: none"> To interrupt the ramp soak operation, choose HOLD ("HLD") in step 2. To cancel the interruption, choose RUN ("RUN") again. "End" will display when ramp soak has completed.
--------------	--

Guaranty soak

This function guarantees the soak time. Only soak time within the specified range of temperature for SV is counted towards soak time.

As seen in the figure below, only the sum of the shaded areas is counted as soak time. The operation moves onto the next step when the total soak time equals the specified soak time.

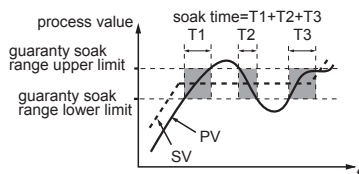

The following steps will explain how to set an example guaranty soak range with an upper limit of 5°C and a lower limit of 3°C.

- 1 Display the ramp soak menu ("PRG H3").
- 2 Display guaranty ON/OFF parameter ("GSOH") and choose on ("OH").
- 3 Display the guaranty soak lower limit parameter ("GS-L") and set the lower limit (in this example, set it to 3°C).
- 4 Display the guaranty soak upper limit parameter ("GS-H") and set the upper limit (in this example, set it to 5°C).
- 5 Press the (SEL) key to set the value.

Mode setting

Sets how you want to run ramp soak.

The following items can be set.

Power On Start	Ramp Soak starts running from the current PV.
Ending Output	Shows the ending output after ramp soak has been completed.
OFF Output	Shows the output during OFF after ramp soak has been completed.
Repeat Behavior	After finishing the last step in ramp soak, the process starts again from 1st step.

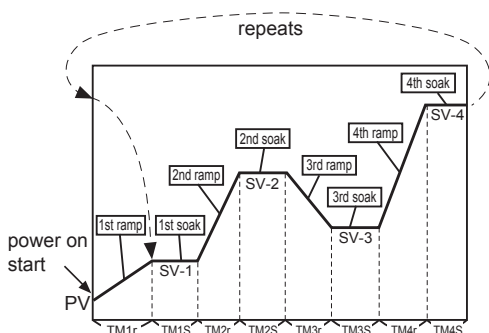

You can choose from the following 16 types of modes according to the combination of run method options.

Setting	Power On Start	Ending Output	OFF Output	Repeat Behavior
"0"	Off	Continuous control	Continuous control	Off
"1"	Off	Continuous control	Continuous control	On
"2"	Off	Continuous control	Standby	Off
"3"	Off	Continuous control	Standby	On
"4"	Off	Standby	Continuous control	Off
"5"	Off	Standby	Continuous control	On
"6"	Off	Standby	Standby	Off
"7"	Off	Standby	Standby	On
"8"	On	Continuous control	Continuous control	Off
"9"	On	Continuous control	Continuous control	On
"10"	On	Continuous control	Standby	Off
"11"	On	Continuous control	Standby	On
"12"	On	Standby	Continuous control	Off
"13"	On	Standby	Continuous control	On
"14"	On	Standby	Standby	Off
"15"	On	Standby	Standby	On

PV start

When the ramp soak starts (RUN), this function searches the first point where the measurement value (PV) and the program pattern match, and starts operation at that point.

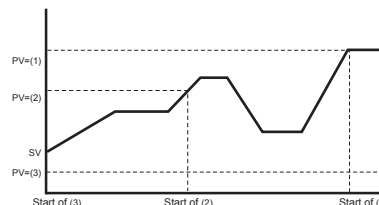

If the measurement value does not match the pattern as with PV = (3), the normal operation starts.

7-10. Other Functions

1. Soft start function

When turning on the equipment (including the temperature controller), the soft start function suppresses the MV to become maximum output. It places an upper limit on MV output for a specified amount of time after power is turned on.

This function is useful for effects such as suppressing the heater output during equipment startup, and makes load lightened.

After the specified time has passed after switching on the equipment (or if SFTM = 0), the soft start function ends and normal controls begin.

Display	Parameter	Function
"SFoI" (SFoI)	MV1 soft start output set value	Places a limit on MV1 output after power is turned on for a time period set in SFTM.
"SFTM" (SFTM)	Soft start set time	Sets the time for soft start to function after turning power on. Setting "0" will turn off soft start.

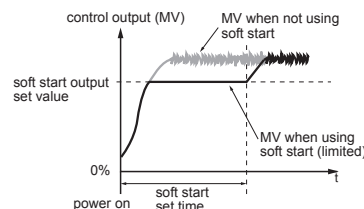

Caution

The soft start function cannot be used simultaneously with the dual control

Point

During manual mode, the manual output value has priority, but soft start will continue to keep track of the set time period.

Use the following steps to set soft start output set value and set time.

- 1 Display the setup menu ("SEt [h3]).
- 2 Display the setup menu ("SFoI").
- 3 Display soft start set time ("SFTM") and set the time.
- 4 Press the (SEL) key to set the value.
- 5 Turn off the power once, and then re-start the controller to begin soft start. (When the soft start function is turned on, the lower display will alternate showing SoFT and SV.)
Note: Do not use auto-tuning at the same time.

2. Error output function

When the error output specification function has concluded that the equipment has an error, it halts the temperature controls and maintains the control output at a previously specified value. There is an error in PV if any of the following conditions occur:

Burnout upper limit / burnout lower limit / underage (PV < -5% FS) / overage (105% < PV)

Use the following steps to set this function.

- 1 Display the setup menu ("SEt [h6]").
- 2 Display FALT output 1 set value ("FLd") and set the output value. For dual control, set "FLd" the same way.
- 3 Press the (SEL) key to set the value.

3. Standby output function

Sets the control output value and the alarm output for standby mode.

Use the following steps to set this function.

- 1 Display the setup menu ("SEt [h6]").
- 2 Display the standby mode setting ("Sbd") and set the alarm output for standby mode.



For the combinations of ON/OFF settings, see "CH6 Setup parameters" (page 11).

- 3 Display the standby control output 1 set value ("Sbd") and set the output value. For dual control, set "Sbd2" the same way.
- 4 Press the (SEL) key to set the value.

4. Ramp SV function

The ramp SV function suppresses a sudden change in SV (step change) when changing SV. It allows SV to change smoothly according to the set slope of temperature per unit of time. This smooth SV change allows you to minimize the effect of the change on controls.

You can set both inclining temperature and declining temperature slopes, and choose from "minutes" or "hours" for the time units.

You can also choose for the SV display to show the current value or the target value during ramp SV.

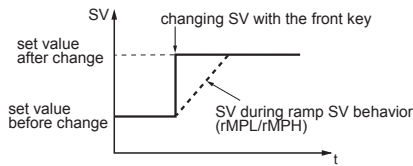

The SV lamp will blink while ramp SV is running. (When not displaying parameters or Ch.) When you turn on the power while ramp SV is in effect, ramp SV will begin using the starting value of PV (PV start)

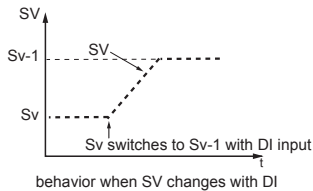
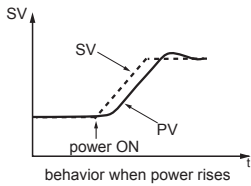

Use the following steps to set this function.

- 1 Display the system menu ("SYs [h7]").
- 2 Set both ramp SV decline ("rMPL") and incline ("rMPH").
- 3 Set the unit of time for the slope ("rMPL") during ramp SV.
- 4 Press the (SEL) key to set the value.

Point

- Ramp SV can be used with remote SV or SV selection functions.
- Ramp SV cannot be used at the same time with ramp soak.
- Coming out of a standby state will begin PV start.
- Make sure to check the controller's parameters after changing PV scale.

Caution

If the power is turned on during the input error, or released standby, the ramp SV operates differently from the normal PV start.

State at PV start	Operation
Standby	PV tracking (Maintains the state where SV=PV. The SV ramp function does not operate.)
Auto or manual	Starts the ramp SV from the current SV (PV start is off)

5. SV selection function

The SV selection function can record and switch up to eight sets of SV information to the palette menu settings. It is effective when the SV used during a process are numerous and the set values have been previously decided.

Use the following steps to save SV information.

- 1 Display the palette menu ("PLt [h2]").
- 2 Display SV setting 1 ("Sv") and set SV1.
- 3 Set SV setting 2 through SV setting 7 in the same way as necessary.
- 4 Press the (SEL) key to set the value.

The following four methods can switch SV.

- Parameter "Sv" / press the user key / DI function / overwrite parameter "Sv" via the communication function

- Switch Using Parameter "Sv"

- 1 Display the operation control mode.
- 2 Display the selected SV number ("Sv") and choose the SV No.
- 3 Press the (SEL) key to set the value.

- Switch Using the User Key

- 1 Display the palette menu ("PLt [h2]").
- 2 Display max selected SV number ("Sv") and set the SV number by choosing it with the user key.
- 3 Display the user key function setting ("UkY") and set it to SV selection function.
- 4 On the PV/SV display, pressing the user key will switch you from the currently selected SV to the next SV.

- Switch Using Parameter "Sv" via the Communication Function
- In the communication, overwrite the set value to the selected SV number ("Sv").

6. PID selection function

Point

When switching the normal and reverse operation by using the PID selection function, be sure to turn off the system power beforehand for safety reasons (Do not switch normal and reverse operation during control).

The SV selection function can record and switch up to eight sets of PID parameters from the palette menu settings.

It is effective when the control equipment changes the target often and must frequently change the PID parameters.

Use the following steps to save PID information.

- 1 Display the palette menu ("PLt [h2]").
- 2 Display proportional bandwidth setting 1 ("P") and set P1.
- 3 Set "i" and "d" in the same way. Set the following parameters as necessary: ON/OFF control hysteresis ("HYs"), cooling proportional band ("Ld"), dead band ("db"), balance ("bAL"), anti-reset windup ("RR"), and normal/reverse setting ("REV").
- 4 Press the (SEL) key to set the value.

The PID parameter selection (P, i, d, normal and reverse settings) can be changed by the same four methods as the SV selection function.

- Switch Using Parameter "PL"

- 1 Display the operation control mode.
- 2 Display the selected PID number ("PL") and choose the PID No.
- 3 Press the (SEL) key to set the value.

- Switch Using the User Key

- 1 Display the palette menu ("PLt [h2]").
- 2 Display max selected PID number ("PL") and set the PID number by choosing it with the user key.
- 3 Display the user key function setting ("UkY") and set it to SV selection function.
- 4 On the PV/SV display, pressing the user key will switch you from the currently selected SV to the next SV.

Point ■■■■

When the user key function code is 27 (SV No.+1, PID No.+1 (send)) and the initial PID No. and SV No. are different, the first time you press the user key, PID No. will become the same as SV No. Also the SVMX parameter value becomes the maximum selectable number for PID No. and SV No.

- Switch Using Parameter "PL #M" via the Communication Channel
- In the communication, overwrite the set value to the selected SV number ("PL #M").

7. Startup mode function

The startup mode specification function sets the controller to start up in any of auto mode, manual mode, remote mode or standby mode. It is used when you want to start up in manual mode.

Use the following steps to set this function.

- 1 Display the system menu ("595 [h 7]").
- 2 Display the startup mode ("5L Md") and choose the operational mode. Choose from auto or manual.
- 3 Press the (SEL) key to set the value. After changing the above setting, restarting the controller will start it in the selected mode.

Point ■■■■

When starting up in manual, the MV becomes 0%.

8. User function key

Pressing the (C) key in the parameter screen will immediately return you to the PV/SV display, regardless of assigned function. Holding the (C) key, (C) key + (C) key, or (C) key + (C) key down for about a second in PV/SV display or PV/MV display will run the assigned function.

Refer to



For functions that can be assigned, see "12 USER key assignment" (page 21).

Use the following steps to set this function.

- 1 Display the system menu ("595 [h 7]").
- 2 Display the assign user key specification ("U#Y I") and choose the function.
- 3 Press the (SEL) key to set the value.

9. bAL and Ar functions

- The anti-reset windup function ("AR") cuts integration that falls outside of the Ar set range that is centered around SV. Running auto-tuning will set the optimum values for P, i, and d parameters, as well as Ar.

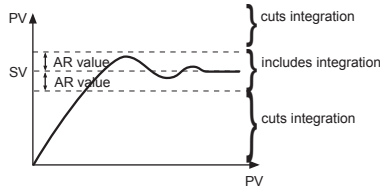

- The output convergence value function ("bAL") outputs to PV and SV a calculated result of the PID computed MV plus the bAL offset. (The factory setting of bAL is 0% for single output, 50% for dual output.)

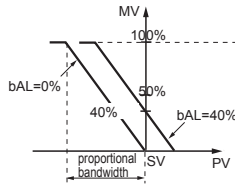

Point ■■■■

Ar1 to Ar7 and bAL1 to bAL7 have the same function as in each PID group.

10. MV limit functions

The MV limit function allows you to choose whether to limit the MV or let it pass through maximum and minimum MV.

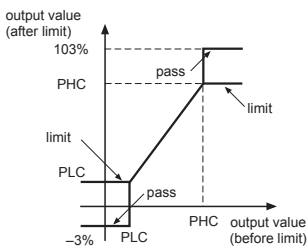

PCUT	MV1		MV2	
	PHC1	PLC1	PHC2	PLC2
"0"	103%	-3%	103%	-3%
"1"	103%	limit	103%	-3%
"2"	limit	-3%	103%	-3%
"3"	limit	limit	103%	-3%
"4"	103%	-3%	103%	limit
"5"	103%	limit	103%	limit
"6"	limit	-3%	103%	limit
"7"	limit	limit	103%	limit
"8"	103%	-3%	limit	-3%
"9"	103%	limit	limit	-3%
"10"	limit	-3%	limit	-3%
"11"	limit	limit	limit	-3%
"12"	103%	-3%	limit	limit
"13"	103%	limit	limit	limit
"14"	limit	-3%	limit	limit
"15"	limit	limit	limit	limit

8. Setting the Temperature Controller

8-1. Input Setting

Set the type and the range for input sensor. Input can be set in the setup menu ("5Et [h 6]"). For more on input types, input scaling, decimal point location, and input codes, see "10 Input Range and Codes (standard range)". (page 19)

1. **Choose an input type ("PV L")**
Check the type of the thermocouple or resistance bulb which is used.
2. **Set the PV scaling (input range) ("PV b"/"PV F")**
Set Pvb to the lower limit of the temperature range and PVF to the upper limit. It is recommended to set the values at the standard range, even though they can be set at values beyond of it. There is no standard range for DC voltage or DC current input. (-1999 to 9999, lower limit<upper limit)
3. **Set the decimal point location ("PV d")**
Sets whether or not to display digits after the decimal point. Two digits can also be displayed after the decimal point when using 1 to 5V DC, and 4 to 20mA DC.

Point ■■■■

PV scaling and decimal point location can be used with the factory settings.

8-2. Output Setting

Sets the control output. (Only when the output is current or voltage.)

1. **Set the range of the control output (OUT1, OUT2) ("I R"/"I 2R")**
Choose any of 0 to 5V, 1 to 5V, 0 to 10V, 2 to 10V, 0 to 20mA or 4 to 20mA DC.

8-3. Control Setting

Sets controls to normal operation or reverse operation.

- Reverse operation: As the process value (PV) rises, the control output (MV) becomes smaller. Used to heat the control object.
- Normal operation: As the process value (PV) rises, the control output (MV) becomes larger. Used to cool the control object.

1. Set the normal or reverse operation ("RE")
Choose any of the following combinations of heat and cool to suit your system.

rEv	Control output 1	Control output 2
rv--	Reverse	-
no--	Normal	-
rvno	Reverse	Normal
norv	Normal	Reverse
rvrv	Reverse	Reverse
nono	Normal	Normal

9. Error Indications

9-1. Display During Equipment Error

This controller has a display function to indicate several types of error code shown below. If any of the error code is displayed, please eliminate the cause of error immediately. After the cause is eliminated, turn off the power once, and then re-start the controller.

Display	Possible cause	Control output
"UUUU"	(1) Thermocouple burnout. (2) Resistance bulb sensor (A) burnout. (3) PV exceeds upper limit of the range by 5%FS.	
"LLLL"	(1) Resistance bulb sensor B or C wire burnout. (2) Resistance bulb sensor (between A & B or A & C) short. (3) PV is below lower limit of the range by 5%FS. (4) Burnout or short in the voltage input.	Output as setting value when an error occurs (set in parameter Flo1 or Flo2)
"LLLL"	(1) PV < -199.9	Control operation is continued (Note) Control operation is continued as long as the accuracy is above -5%FS. When the accuracy declines to be lower than -5%FS, the controller outputs the specified value for an error.
"ERR" (SV flickers)	Incorrect setting (Pvb/PvF)	The controller outputs the specified value for an error. (The value can be set in parameter Flo1 or Flo2)
PV is not displayed	Check the set value of DSPT.	Normal control * The controller does not have to be restarted
SV is not displayed	Check the set value of DSPT.	Normal control * The controller does not have to be restarted
Parameters may not be displayed	Check the settings of Ch11 DSP	Normal control * The controller does not have to be restarted

10. Input Range and Codes (standard range)

Input type	Input code (PVT)	Measurement range (°C) (PVb, PVF)	Minimum input increment (°C)	Measurement range (°F) (PVb, PVF)	Minimum input increment (°F)	
RTD JIS (IEC)	JPt 100	JPT1	0.0 to 150.0	0.1	32.0 to 302.0	0.1
		JPT2	0.0 to 300.0	0.1	32.0 to 572.0	0.1
		JPT3	0.0 to 500.0	0.1	32.0 to 932.0	0.1
		JPT4	0.0 to 600.0	0.1	32 to 1112	1
		JPT5	-50.0 to 100.0	0.1	-58.0 to 212.0	0.1
		JPT6	-100.0 to 200.0	0.1	-148.0 to 392.0	0.1
		JPT7	-199.9 to 600.0	0.1	-328 to 1112	1
	Pt 100	PT1	0.0 to 150.0	0.1	32.0 to 302.0	0.1
		PT2	0.0 to 300.0	0.1	32.0 to 572.0	0.1
		PT3	0.0 to 500.0	0.1	32.0 to 932.0	0.1
		PT4	0.0 to 600.0	0.1	32 to 1112	1
		PT5	-50.0 to 100.0	0.1	-58.0 to 212.0	0.1
		PT6	-100.0 to 200.0	0.1	-148.0 to 392.0	0.1
		PT7	-199.9 to 600.0	0.1	-328 to 1112	1
Thermocouple	J	J1	0.0 to 400.0	0.1	32.0 to 752.0	0.1
		J2	-20.0 to 400.0	0.1	-4.0 to 752.0	0.1
		J3	0.0 to 800.0	0.1	32 to 1472	1
		J4	-100 to 1000	1	-148 to 1832	1
	K	K1	0 to 400	0.1	32 to 752	0.1
		K2	-20.0 to 500.0	0.1	-4.0 to 932.0	0.1
		K3	0.0 to 800.0	0.1	32 to 1472	1
		K4	-200 to 1300	1	-328 to 2372	1
	R	R	0 to 1700	1	32 to 3092	1
	B	B	0 to 1800	1	32 to 3272	1
	S	S	0 to 1700	1	32 to 3092	1
	T	T1	-199.9 to 200.0	0.1	-199.9 to 392.0	0.1
		T2	-199.9 to 400.0	0.1	-199.9 to 752.0	0.1
	E	E1	0.0 to 800.0	0.1	32 to 1472	1
		E2	-150.0 to 800.0	0.1	-238 to 1472	1
		E3	-200 to 800	1	-328 to 1472	1
	L	L	-100 to 850	1	-148 to 1562	1
		U	U1	-199.9 to 400.0	0.1	-199.9 to 752.0
	U	U2	-200 to 400	1	-328 to 752	1
N		N	-200 to 1300	1	-328 to 2372	1
W	W	0 to 2300	1	32 to 4172	1	
	PL-II	PL-2	0 to 1300	1	32 to 2372	1
DC voltage	0 to 5 V DC	0-5V	-1999 to 9999 (Range where scaling is allowed)	-	-1999 to 9999 (Range where scaling is allowed)	-
	1 to 5 V DC	1-5V				
	0 to 10V DC	0-10				
	2 to 10V DC	2-10				
	0 to 100mV DC	MV				
DC current	0 to 20 mA DC	0-20	-	-	-	-
	4 to 20 mA DC	4-20				

11. Alarm Action Type Codes

Type	A1Tp to A5Tp	Alarm Type	Action diagram
Absolute value alarm	0	No alarm	
	1	High alarm	
	2	Low alarm	
	3	High alarm (with hold)	
Deviation alarm	4	Low alarm (with hold)	
	5	High alarm	
	6	Low alarm	
	7	High/Low alarm	
	8	High alarm (with hold)	
	9	Low alarm (with hold)	
	10	High/Low alarm (with hold)	
Zone alarm	11	High/Low deviation alarm	

• Dual Set Value Alarm Codes

Type	A1Tp to A5Tp	Alarm Type	Action diagram	
High/Low limit alarm	16	High/Low absolute alarm		
	17	High/Low deviation alarm		
	18	High absolute/Low deviation alarm		
	19	High deviation/Low absolute alarm		
	20	High/Low absolute alarm (with hold)		
	21	High/Low deviation alarm (with hold)		
	22	High absolute/Low deviation alarm (with hold)		
	23	High deviation/Low absolute alarm (with hold)		
	Zone alarm	24	High/Low absolute alarm	
		25	High/Low deviation alarm	
		26	High absolute/Low deviation alarm	
27		High deviation/Low absolute alarm		
28		High/Low absolute alarm (with hold)		
29		High/Low deviation alarm (with hold)		
30		High absolute/Low deviation alarm (with hold)		
31		High deviation/Low absolute alarm (with hold)		

• Timer Code, other

Type	A1Tp to A5Tp	Alarm Type	Action diagram
Timer	32	ON delay timer	
	33	OFF delay timer	
	34	ON/OFF delay timer	
	35	Delay start ON	
Ramp soak delay start	37	Open loop alarm	
	38	Heater burnout alarm (Optional CT is required)	
Power	41	Shorted load alarm (Optional CT is required)	
	45	Amount of electric energy	
Maintenance	46	Preventive maintenance. The number of times that the relay has operated (MV1, MV2)	
	47	Preventive maintenance. Operated hours	

What is alarm with hold?

The alarm will not turn ON immediately when the process value gets into the alarm band and enters again. If without hold, alarm may turn ON when starting up.

Point

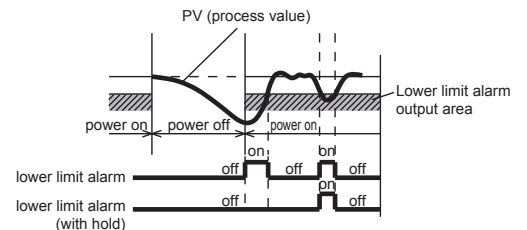

Caution

- When alarm action code is changed, alarm set value may also become different from previous settings.
- When alarm action type code is changed, turn off the power once, and then re-start the controller, before starting control.
- ALn: AL1 to AL5 show the alarm set values
- ALnh: AL1h to AL5h show the alarm set values
- ALnL: AL1L to AL5L show the alarm set values
- dLYn: dLY1 to dLY5 show the alarm delay on set values

* Other than the alarm setting, each of the event output functions can be assigned to DO1 to 5.
For more details on each of the event output functions, refer to "13. OUT, DO, indicators assignment" (page 21).

12. USER key assignment

UkY 1 to 3 set value	Key function
0	No function
1	Switchover between STBY ON/OFF
2	Switchover between Auto/Manual
3	Switchover between Locul/Remote
4	Setting unavailable
5	Starts AT (standard)
6	Starts AT (low PV)
7	Setting unavailable
8	Ramp SV HOLD
9	Ramp soak RUN/OFF
10	Ramp soak RUN/HOLD
11	Setting unavailable
12	Latch release (all)
13	Latch release (ALM1)
14	Latch release (ALM2)
15	Latch release (ALM3)
16	Latch release (ALM4)
17	Latch release (ALM5)
19	Start timer (ALM1)
20	Start timer (ALM2)
21	Start timer (ALM3)
22	Start timer (ALM4)
23	Start timer (ALM5)
25	SVNo. + 1 (send)
26	PID No. + 1 (send)
27	Setting unavailable
28	Ramp soak pattern No. + 1 (send)
29	SV No. + 1, PID No. + 1 (send)

13. OUT, Alarm output, indicators assignment

OUT (Relay/SSR)	OUT (Current/Voltage)	Alarm output	Indicator	Category	Function
oU1T, oU2T	oU1T oU2T	do1T, do2T, do3T, do4T, do5T	LoU1, LoU2, LEV 1 to 3, LSTb, LMAN		
0	0	0	0		None
1	1	1	1	Control output	MV1 (heating)
2	2	2	2		MV2 (cooling)
3	—	3	3	Alarm output	Alarm 1
4	—	4	4		Alarm 2
5	—	5	5		Alarm 3
6	—	6	6		Alarm 4
7	—	7	7		Alarm 5
10	—	10	10	Status output	During auto-tuning startup
11	—	11	11		Normal
12	—	12	12		Standby
13	—	13	13		During manual mode
14	—	14	14		During remote SV operation
15	—	15	15		During ramp SV
16	—	16	16		System error
20	—	20	20	Ramp soak event output	OFF
21	—	21	21		RUN
22	—	22	22		HOLD
23	—	23	23		GS (Guaranty soak)
24	—	24	24		END
170	—	170	170	Ramp soak Time signal	Time signal (step 1 ramp)
171	—	171	171		Time signal (step 1 soak)
172	—	172	172		Time signal (step 2 ramp)
173	—	173	173		Time signal (step 2 soak)
⋮	⋮	⋮	⋮		⋮
294	—	294	294		Time signal (step 63 ramp)
295	—	295	295		Time signal (step 63 soak)
296	—	296	296		Time signal (step 64 ramp)
297	—	297	297		Time signal (step 64 soak)
300	—	300	300	Ramp soak Relative time signal	Time signal (1st step ramp)
301	—	301	301		Time signal (1st step soak)
302	—	302	302		Time signal (2nd step ramp)
303	—	303	303		Time signal (2nd step soak)
⋮	⋮	⋮	⋮		⋮
424	—	424	424		Time signal (63rd step ramp)
425	—	425	425		Time signal (63rd step soak)
426	—	426	426		Time signal (64th step ramp)
427	—	427	427		Time signal (64th step soak)

14. Model Specifications

You can allocate one of the following functions to each of DI1, DI2, and DI3. These functions are activated by external DI signals.

No.	Function	Action	ON	OFF	Criteria
0	No function	No action	—	—	—
1	Standby ON/OFF switchover	Switches between Standby ON/OFF.	Standby	Cancels Standby	Edge
2	Auto/manual switchover	Switches the control output action between auto/manual.	Manual	Auto	Edge
3	Local/remote switchover	Switches SV between local/remote.	Remote	Local	Edge
4	No function	Not for use.	—	—	—
5	Auto tuning (standard) start	Runs standard auto-tuning.	Start	Stop	Edge
6	Auto tuning (low-PV) start	Runs low-PV type auto-tuning.	Start	Stop	Edge
7	Ramp SV ON/OFF	Enables or disables ramp SV.	Disable	Enable	Edge
8	Ramp SV hold	Switches between ramp SV hold and hold cancel.	Hold	Hold cancel	Edge
9	Ramp soak RUN/OFF	Switches between ramp soak RUN/OFF.	RUN	OFF	Edge
10	Ramp soak RUN/HOLD	Switches between ramp soak RUN/HOLD.	RUN	HOLD	Edge
11	No function	Not for use.	—	—	—
12	Unlatch (all)	Cancels all the alarm latches.	Unlatch	—	Edge
13	Unlatch (alarm 1)	Unlatches the alarm 1.			
14	Unlatch (alarm 2)	Unlatches the alarm 2.			
15	Unlatch (alarm 3)	Unlatches the alarm 3.			
16	Unlatch (alarm 4)	Unlatches the alarm 4.			
17	Unlatch (alarm 5)	Unlatches the alarm 5.			
18	No function	Not for use.	—	—	—
19	Timer (alarm 1)	Runs the timer for the alarm 1.	Timer ON	Timer OFF	Level
20	Timer (alarm 2)	Runs the timer for the alarm 2.			
21	Timer (alarm 3)	Runs the timer for the alarm 3.			
22	Timer (alarm 4)	Runs the timer for the alarm 4.			
23	Timer (alarm 5)	Runs the timer for the alarm 5.			
24	No function	Not for use.	—	—	—
25	SV No. + 1	Increases the SV number by 1.	+1	—	Level
26	SV No. + 2	Increases the SV number by 2.	+2	—	Level
27	SV No. + 4	Increases the SV number by 4.	+4	—	Level
28	PID No. + 1	Increases the PID number by 1.	+1	—	Level
29	PID No. + 2	Increases the PID number by 2.	+2	—	Level
30	PID No. + 4	Increases the PID number by 4.	+4	—	Level
31	SV No. + 1, PID No. + 1	Increases both the SV number and PID number by 1.	+1	—	Level
32	SV No. + 2, PID No. + 2	Increases both the SV number and PID number by 2.	+2	—	Level
33	SV No. + 4, PID No. + 4	Increases both the SV number and PID number by 4.	+4	—	Level
34	Ramp soak OFF	Stops ramp soak operation.	OFF	—	Edge
35	Ramp soak RUN	Runs ramp soak.	RUN	—	Edge
36	Ramp soak HOLD	Holds ramp soak.	HOLD	—	Edge
37	Pattern No. + 1	Increases the pattern number by 1.	+1	—	Level
38	Pattern No. + 2	Increases the pattern number by 2.	+2	—	Level
39	Pattern No. + 4	Increases the pattern number by 4.	+4	—	Level
40	Pattern No. + 8	Increases the pattern number by 8.	+8	—	Level
41	DI soft start	Starts DI soft start.	Start	—	Edge
42	No function	Not for use.	—	—	—
43	Delay start (alarm 1)	Enables delay start with the delay time = dLY1.	Delay start enable		—
44	Delay start (alarm 2)	Enables delay start with the delay time = dLY2.	Delay start enable		—
45	Delay start (alarm 3)	Enables delay start with the delay time = dLY3.	Delay start enable		—
46	Delay start (alarm 4)	Enables delay start with the delay time = dLY4.	Delay start enable		—
47	Delay start (alarm 5)	Enables delay start with the delay time = dLY5.	Delay start enable		—
48	No function	Not for use.	—	—	—

15. Model Specifications

15-1. SW49 & SW96 (Standard type)

	TYPE	SYROS									
		SW49	SW96	A	B	C	D	E	F	G	
	Front panel size L x H 48 x 96 mm (SW49) Front panel size L x H 96 x 96 mm (SW96)										
A	CONTROL OUTPUT 1										
	Relay contact (SPST)			1							
	Relay contact (SPDT)			2							
	SSR drive control			3							
	Current output (0-20 mADC / 4-20 mADC)			4							
	Voltage output (0-5 VDC / 1-5 VDC/ 0-10 VDC / 2-10 VDC)			5							
B	CONTROL OUTPUT 2										
	None				0						
	Relay contact (SPST)				1						
	SSR drive control				2						
	Current output (0-20 mADC / 4-20 mADC)				3						
	Voltage output (0-5 VDC / 1-5 VDC/ 0-10 VDC / 2-10 VDC)				4						
	Re-transmission output (Current 0-20 mADC / 4-20 mADC)				5						
	Re-transmission output (Voltage 0-5 VDC / 1-5 VDC/ 0-10 VDC / 2-10 VDC)				6						
C	ALARM OUTPUT										
	None					0					
	1 point					1					
	2 points					2					
	3 points					3					
	2 points (independent common)					4					
D	POWER SUPPLY										
	100-240 VAC						1				
	24 VDC / 24 VAC						2				
E	OPTIONS										
	None								0		
	RS485 Communication								1		
	Digital Input (DI1, DI2)								2		
	Remote setpoint + Digital input (DI3) Note 2								3		
	CT input + Digital input (DI1) Note 1								4		
	RS485 communication + Digital input (DI1)								5		
	RS485 communication + Digital input (DI3,4,5) + (Alarm AL4, 5)								6		
F	SPECIAL VERSION									0	
G	SPECIAL VERSION										0
NOTES:											
1- When using the CT input as heather burnout alarm,add one alarm output in the (C) code.											
2- When using the current input for the remote SV input, add a 250 Ohm resistor to the input terminal.											

	TYPE (MOTORIZED VALVE CONTROL)	SYROS										
	Front panel size L x H 48 x 96 mm (SW49) Front panel size L x H 96 x 96 mm (SW96)	SW49	SW96		A	B	C	D	E	F	G	
A	CONTROL OUTPUT 1											
	Motorized valve control output (without PFB input)				S							
	Motorized valve control output (with PFB input)				V							
B	CONTROL OUTPUT 2											
	None					0						
C	ALARM OUTPUT											
	None						0					
	1 point						1					
	2 points						2					
	2 points (independent common)						3					
D	POWER SUPPLY											
	100 - 240 VAC							1				
	24 VDC / 24 VAC							2				
E	OPTIONS											
	None								0			
	RS485 Communication + Digital input (DI1,2,3)								1			
F	SPECIAL VERSION									0		
G	SPECIAL VERSION										0	

16. Specifications

Power supply voltage	100 (-15%) to 240 (+10%) V AC, 50/60Hz, 24 (±10%) V DC/AC, 50/60Hz
Power consumption	13 VA MAX. (100 to 240 V AC), 8 VA MAX. (24 V DC/AC)
Control output	Relay contact output 1 SPST contact, 250 V AC/30 V DC, 3 A (resistive load) 1 SPDT contact, 250 V AC/30 V DC, 5 A (resistive load) SSR/SSC drive output (voltage pulse output) ON voltage: 12 V DC (10.7 to 13.2 V DC) OFF voltage: 0.5 V DC or lower Maximum current: 20 mA DC Load resistance: 600 Ω MIN. Current output 0 to 20 mA DC/4 to 20 mA DC Accuracy: ±5%FS Load resistance: 500 Ω MAX. Voltage output 0 to 5 V DC/1 to 5 V DC/0 to 10 V DC/2 to 10 V DC Accuracy: ±5%FS Load resistance: 10 kΩ MIN.
Process value input	Accuracy Thermocouple input: either ±1°C ±1 digit or ±0.3% of indicated value ±1 digit, whichever is larger *except: Thermocouple B: 0°C to 400°C: no accuracy assurance Thermocouple R: 0°C to 500°C: ±3°C ±1 digit Other thermocouples: -200°C to -100°C: ±2°C ±1 digit RTD input: ±0.8°C ±1 digit or ±0.2% of indicated value ±1 digit, whichever is larger mV input, voltage input, current input: ±0.3%FS ±1 digit
Alarm output	Relay contact output (AL1 to AL5) 1 SPST contact, 250 V AC/30 V DC, 1 A (resistive load)
Digital input	Number of inputs: 3 Contact capacity: 5 V DC, 2 mA (per point) Input pulse width: 50 ms MIN. ON judgment: 2 V DC or lower OFF judgment: 3 V DC or higher
Transfer output	0 to 20 mA DC/4 to 20 mA DC 0 to 5 V DC/1 to 5 V DC/0 to 10 V DC/2 to 10 V DC) Transfer data: PV, SV, DV, MV Accuracy: ±0.2%FS (±5%FS current output for 1 mA or lower) Load resistance: 500 Ω MAX. (current), 10 kΩ MIN. (voltage)
Remote SV input	0 to 5 V DC/1 to 5 V DC/0 to 10 V DC/2 to 10 V DC 0 to 20 mA DC/4 to 20 mA DC (an external resistance of 250 Ω is required for current input)
Current transformer (CT) input	Single phase current transformer: 1 point, for 1 to 30 A/20 to 100 A
Valve feedback signal(potentiometer) input	Resistance range: 100 to 2.5kΩ (three line type) Resolution: 0.5% FS Input accuracy: ±1.0% FS Corresponding full stroke time: 30 sec to 180 sec
Valve position feedback input (Potentiometer)	SPST contact × 2 [without interlock circuit], 250 V AC/30 V DC, 3 A (resistive load)
Communication	RS-485 interface Communication method: Half-duplex bit serial, asynchronous communication Transmission rate: 9600 bps, 19200 bps, 38400 bps, 115400 bps Protocol: Modbus RTU compatible Transmission distance: Up to 500 m (total connection length) Connectable units: 31 units MAX.
Loader interface	TTL Level Connection method: dedicated cable Communication method: Half-duplex bit serial, asynchronous communication Transmission rate: 38400 bps, no parity Protocol: Modbus RTU compatible
Storage temperature and humidity	-20°C to 60°C, 90%RH or less (no condensation)
Operating temperature and humidity	-10°C to 50°C, 90%RH or less (no condensation)
Altitude	up to 2000 m
Recommemd fuse	250V AC, 0.1A T (Time-Lag) for 100 to 240V AC Power supply, 400V DC/400V AC, 1A T (Time-Lag) for 24V DC/24V AC Power supply
Service life	10 years (under an average ambient temperature of 25°C) The life is shortened by half when the temperature rises by 10°C (Arrhenius' law). If you use the controller inside a cabinet or the like, please note that the ambient temperature can rise.

17. Limited warranty

1. Scope of warranty

If malfunction occurs in the period of warranty due to DITEL, the malfunctioning parts are exchanged or repaired for free.

However, in the case where an engineer needs to visit your place for replacement or repair, you will be charged our call out fee.

Please note that we cannot provide commissioning and/or readjustment for whole system including our product at repair or replacement of failed parts.

The warranty does not apply to the following cases.

- (1) The malfunction occurs due to inappropriate conditions, environment, handling or usage that is not instructed in a catalog, instruction book or user's manual.
- (2) The malfunction is caused by the factors that do not originate in the purchased or delivered product.
- (3) The malfunction is caused by other devices or software design that does not originate in DITEL products.
- (4) The malfunction occurs due to an alteration or repair that is not performed by DITEL.
- (5) The malfunction occurs because the expendable parts listed in an instruction book or connectable were not maintained nor exchanged in an appropriate manner.
- (6) The malfunction occurs due to factors that were not foreseeable by the practical application of science and technology at the time of purchase or delivery.
- (7) The malfunction occurs because the product is used for an unintended purpose.
- (8) The malfunction occurs due to a disaster or natural disaster that DITEL is not responsible for.

2. Exclusion of liability for loss of opportunity

Regardless of the time period of the occurrence, the amount of compensation assumed by DITEL for damage, excluding which is caused by intentional acts or acts of gross negligence or illegal act by DITEL, shall not exceed the amount stipulated in the contract with the customer.

DITEL is not liable for the damage to products that were not manufactured by DITEL, incidental damages or consequential damages, or damage caused due to special situations regardless of whether it was foreseeable or not, or passive damages such as opportunity loss or lost profits of the purchaser.

3. Scope of application

- This equipment must be used under the following conditions:
 - The use of the equipment incurs no risk of a serious accident even if a failure or malfunction occurs on the equipment, and in case of product failure or malfunction, safety measures such as redundant design, prevention of malfunction, fail safe setting, foolproof mechanism are provided outside of the equipment by the user.
- The product described in this document is designed and manufactured as a general-purpose products for general industrial applications.
- The warranty does not apply to the following cases:
 - For the use not described in or beyond the conditions or environment specified in the instruction manual or the user manual,
 - For the use which has large influence on publicity including nuclear power and other power generation, gas, and/or water,
 - For the use in which safety is especially required, because it may seriously affect railroads, vehicles, combustion equipment, medical equipment, entertainment devices, safety equipment, defense equipment, and/or human lives and property.

However, we will study the possibility of application of the equipment for the above use, if the user limits the usage of it and agrees to require no special quality. Please consult us.