

**OPERATION MANUAL
FOR DISPLAYS SERIES
DN-109NW, DN-119NW,
DN-129NW AND DN-189NW**

Index

1. INTRODUCTION.....	1-1
2. GENERAL CHARACTERISTICS.....	2-1
2.1. Electrical characteristics	2-1
2.1.1. Electrical characteristics of the DN-109 displays.....	2-1
2.1.2. Electrical characteristics of the DN-119 displays.....	2-1
2.1.3. Electrical characteristics of the DN-189 displays.....	2-1
2.1.4. Electrical characteristics of the DN-129 displays.....	2-2
2.2. Display weight and power consumption.....	2-3
2.2.1. DN-109 weight and power consumption.....	2-3
2.2.2. DN-119 weight and power consumption.....	2-3
2.2.4. DN-189 weight and power consumption.....	2-4
2.2.5. DN-129 weight and power consumption.....	2-4
2.3. Dimensions and mounting of the Displays	2-5
2.3.1. Dimensions and mounting of the DN-109 and DN-119	2-5
2.3.2. Dimensions and mounting of the DN-129 and DN-189	2-6
3. INSTALLATION.....	3-1
3.1. Power supply.....	3-1
3.2. Connecting the antenna.....	3-2
4. OPERATION.....	4-1
4.1. Initial reset.....	4-1
4.2. Programming parameters.....	4-1
4.2.1. Enter to modify parameters.....	4-2
4.2.2. Exit modify parameters.....	4-2
4.2.3. Function of each parameter.....	4-2
4.3. Protocols.....	4-5
4.3.1. TCP/IP Protocol	4-5
4.3.2. Modbus/TCP Protocol.....	4-5
4.4. IP address.....	4-7
4.4.1. Accessing Wifi module configuration	4-9
4.5. Set up IP Address using the DeviceInstaller.....	4-12
4.6. Modifying the port settings.....	4-12

1. INTRODUCTION

The numerical displays for series **DN-109NW**, **DN-119NW**, **DN-129NW** and **DN-189NW**, are industrial displays for control by Wifi network and can be configured for use with TCP/IP and Modbus/TCP protocols. All of the units have the option of adding a symbol, in text format, of a maximum of three characters.

The selection of the parameters and the communication protocol is done using two buttons with a system of easily programmable codes.

One of its main characteristics is the large size of the characters,

DN-109NW of **57mm** legible at 30m.

DN-119NW of **100 mm** legible at 50m.

DN-129NW of **250 mm** legible at 100m.

DN-189NW of **120 mm** legible at 90m.

As with other display series, the **DN-109NW**, **DN-119NW**, **DN-129NW** and **DN-189NW** series is also available in **one or two-sided** versions, which provides multiple solutions and installation possibilities.

It is surface mounted, with fixtures to a wall or partition wall, or suspended by the side anchoring.

The application field of these displays is very wide in all types of industrial applications utilising the advantages of the Wifi network. They can be used to display Scada program values, counter values from a PLC.

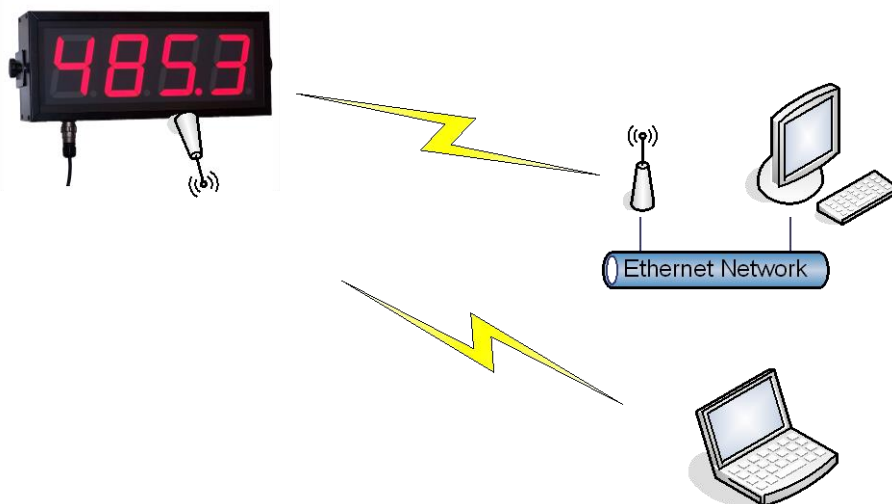

2. GENERAL CHARACTERISTICS.

2.1. Electrical characteristics

2.1.1. Electrical characteristics of the DN-109 displays.

Supply Voltage	88 to 264 VAC 47 to 63Hz.
Consumption	See "Display weight and power consumption."
Display	7 segments, 57mm high + decimal point. Red Led colour. Viewing distance: max 30 meters.
Text (LED)	Formed by leds of 5mm diameter, 50mm character height.
Text (Vinyl)	White vinyl. 50mm character height.
Parameter memory	Eeprom.
Communication	IEEE 802.11b and IEEE 802.11g.
Communication Protocols	TCP/IP and Modbus/TCP.
Environmental Conditions	Operation Temperature: -20 to 60°C. Storage temperature: -30°C to 70°C. Humidity: 5-95% RH non condensing. Maximum environmental illumination: 1000 lux. Sealing: IP41 or IP65.

2.1.2. Electrical characteristics of the DN-119 displays.

Supply Voltage	88 to 264 VAC 47 to 63Hz.
Consumption	See "Display weight and power consumption."
Display	7 segments, 100mm high + decimal point. Red Led colour. Viewing distance: max 50 meters.
Text (LED)	Formed by leds of 5mm diameter, 65mm character height.
Text (Vinyl)	White vinyl. 65mm character height.
Parameter memory	Eeprom.
Communication	IEEE 802.11b and IEEE 802.11g.
Communication Protocols	TCP/IP and Modbus/TCP.
Environmental Conditions	Operation Temperature: -20 to 60°C. Storage temperature: -30°C to 70°C. Humidity: 5-95% RH non condensing. Maximum environmental illumination: 1000 lux. Sealing: IP41 or IP65.

2.1.3. Electrical characteristics of the DN-189 displays.

Supply Voltage	88 to 264 VAC 47 to 63Hz.
Consumption	See "Display weight and power consumption."
Display	7 segments, 180mm high + decimal point. Red Led colour. Viewing distance: max 90 meters.
Text (Vinyl)	White vinyl.
Parameter memory	Eeprom.
Communication	IEEE 802.11b and IEEE 802.11g.
Communication Protocols	TCP/IP and Modbus/TCP.
Environmental Conditions	Operation Temperature: -20 to 60°C. Storage temperature: -30°C to 70°C. Humidity: 5-95% RH non condensing. Maximum environmental illumination: 1000 lux. Sealing: IP41 or IP65.

2.1.4. Electrical characteristics of the DN-129 displays.

Supply Voltage	88 to 264 VAC 47 to 63Hz.
Consumption	See "Display weight and power consumption."
Display	7 segments, 250mm high + decimal point.
.....	Red Led colour. Viewing distance: max 120 meters.
Text (Vinyl)	White vinyl.
Parameter memory	Eeprom.
Communication	IEEE 802.11b and IEEE 802.11g.
Communication Protocols	TCP/IP and Modbus/TCP.
Environmental Conditions	Operation Temperature: -20 to 60°C.
.....	Storage temperature: -30°C to 70°C.
.....	Humidity: 5-95% RH non condensing.
.....	Maximum environmental illumination: 1000 lux.
.....	Sealing: IP41 or IP54.

2.2. Display weight and power consumption.

2.2.1. DN-109 weight and power consumption.

Reference	Display Weight (kg)	Power (W)	Reference	Display weight (kg)	Power (W)	Reference	Display weight (kg)	Power (W)
DN-109/3S	3,0	5,9	DN-109/3S+TL	3,0	7,9	DN-109/3S+TV	3,0	5,9
DN-109/3D	3,0	10	DN-109/3D+TL	3,0	11,7	DN-109/3D+TV	3,0	10
DN-109/4S	3,0	7,54	DN-109/4S+TL	3,5	9,6	DN-109/4S+TV	3,5	7,54
DN-109/4D	3,5	14,44	DN-109/4D+TL	3,5	15,1	DN-109/4D+TV	3,5	14,44
DN-109/5S	3,0	9,2	DN-109/5S+TL	3,5	11,2	DN-109/5S+TV	3,5	9,2
DN-109/5D	3,5	18	DN-109/5D+TL	4,5	21,7	DN-109/5D+TV	4,0	18
DN-109/6S	3,5	10,7	DN-109/6S+TL	4,0	12,8	DN-109/6S+TV	4,0	10,7
DN-109/6D	4,0	20,85	DN-109/6D+TL	4,5	25	DN-109/6D+TV	4,0	20,85
DN-109/7S	4,0	12,36	DN-109/7S+TL	4,0	14,4	DN-109/7S+TV	4,0	12,36
DN-109/7D	4,5	24,1	DN-109/7D+TL	5,0	28,1	DN-109/7D+TV	5,0	24,1
DN-109/8S	4,0	14	DN-109/8S+TL	4,5	16	DN-109/8S+TV	4,5	14
DN-109/8D	5,0	27,3	DN-109/8D+TL	5,5	31,3	DN-109/8D+TV	5,5	27,3
DN-109/9S	4,5	15,7	DN-109/9S+TL	4,5	17,6	DN-109/9S+TV	4,5	15,7
DN-109/9D	5,0	30,5	DN-109/9D+TL	5,5	34,6	DN-109/9D+TV	5,5	30,5
DN-109/10S	4,5	17,2	DN-109/10S+TL	5,0	19,2	DN-109/10S+TV	5,0	17,2
DN-109/10D	5,5	33,7	DN-109/10D+TL	6,0	37,7	DN-109/10D+TV	6,0	33,7

2.2.2. DN-119 weight and power consumption.

Reference	Display Weight (kg)	Power (W)	Reference	Display weight (kg)	Power (W)	Reference	Display weight (kg)	Power (W)
DN-119/3S	4,0	10,8	DN-119/3S+TL	4,5	13,4	DN-119/3S+TV	4,5	10,8
DN-119/3D	4,0	18	DN-119/3D+TL	5,0	20	DN-119/3D+TV	5,0	18
DN-119/4S	4,5	14	DN-119/4S+TL	5,5	16,6	DN-119/4S+TV	5,5	14
DN-119/4D	5,0	26,6	DN-119/4D+TL	5,5	31,9	DN-119/4D+TV	5,5	26,6
DN-119/5S	5,0	17	DN-119/5S+TL	5,5	19,7	DN-119/5S+TV	5,5	17
DN-119/5D	5,5	32,9	DN-119/5D+TL	6,0	38,1	DN-119/5D+TV	6,0	32,9
DN-119/6S	5,5	20,2	DN-119/6S+TL	6,0	22,8	DN-119/6S+TV	6,0	20,2
DN-119/6D	6,0	39,2	DN-119/6D+TL	6,5	44,5	DN-119/6D+TV	6,5	39,2
DN-119/7S	6,0	23,3	DN-119/7S+TL	7,0	25,9	DN-119/7S+TV	7,0	23,3
DN-119/7D	3,5	25,5	DN-119/7D+TL	7,5	50,8	DN-119/7D+TV	7,5	25,5
DN-119/8S	6,5	26,4	DN-119/8S+TL	7,5	29	DN-119/8S+TV	7,5	26,4
DN-119/8D	7,0	51,6	DN-119/8D+TL	8,0	56,8	DN-119/8D+TV	8,0	51,6
DN-119/9S	7,0	29,4	DN-119/9S+TL	8,0	32	DN-119/9S+TV	8,0	29,4
DN-119/9D	7,5	57,6	DN-119/9D+TL	8,5	62,9	DN-119/9D+TV	8,5	57,6
DN-119/10S	7,5	32,5	DN-119/10S+TL	8,5	35,2	DN-119/10S+TV	8,5	32,5
DN-119/10D	8,0	64	DN-119/10D+TL	9,0	69	DN-119/10D+TV	9,0	64

2.2.4. DN-189 weight and power consumption.

Reference	Display Weight (kg)	Power (W)	Reference	Display weight (kg)	Power (W)
DN-189/2S	4,0	13,3	DN-189/2S+TV	5,5	13,3
DN-189/2D	4,5	25,8	DN-189/2D+TV	6,5	25,8
DN-189/3S	5,0	19,4	DN-189/3S+TV	6,5	19,4
DN-189/3D	6,0	38,2	DN-189/3D+TV	8,0	38,2
DN-189/4S	6,0	25,7	DN-189/4S+TV	7,5	25,7
DN-189/4D	7,5	50,8	DN-189/4D+TV	9,0	50,8
DN-189/5S	7,0	31,8	DN-189/5S+TV	9,0	31,8
DN-189/5D	8,5	63,2	DN-189/5D+TV	10,5	63,2
DN-189/6S	8,5	37,8	DN-189/6S+TV	10,0	37,8
DN-189/6D	10,0	75,5	DN-189/6D+TV	11,5	75,5
DN-189/7S	9,5	44	DN-189/7S+TV	11,0	44
DN-189/7D	11,0	88,1	DN-189/7D+TV	13,0	88,1
DN-189/8S	10,5	50,3	DN-189/8S+TV	12,0	50,3
DN-189/8D	12,5	100,6	DN-189/8D+TV	14,0	100,6
DN-189/9S	11,0	56,6	DN-189/9S+TV	13,0	56,6
DN-189/9D	13,5	113,2	DN-189/9D+TV	15,5	113,2
DN-189/10S	12,0	62,9	DN-189/10S+TV	14,0	62,9
DN-189/10D	15,0	125,8	DN-189/10D+TV	16,5	125,8

2.2.5. DN-129 weight and power consumption.

Reference	Display Weight (kg)	Power (W)	Reference	Display weight (kg)	Power (W)
DN-129/2S	6,5	13	DN-129/2S+TV	9,5	13
DN-129/2D	8,0	26	DN-129/2D+TV	11,5	26
DN-129/3S	8,5	20	DN-129/3S+TV	11,5	20
DN-129/3D	10,5	40	DN-129/3D+TV	13,5	40
DN-129/4S	10,5	26	DN-129/4S+TV	13,0	26
DN-129/4D	13,0	52	DN-129/4D+TV	16,0	52
DN-129/5S	12,0	32	DN-129/5S+TV	15,0	32
DN-129/5D	15,5	64	DN-129/5D+TV	18,5	64
DN-129/6S	14,0	40	DN-129/6S+TV	17,0	40
DN-129/6D	18,0	77	DN-129/6D+TV	21,0	77
DN-129/7S	16,0	45	DN-129/7S+TV	18,5	45
DN-129/7D	20,0	90	DN-129/7D+TV	23,5	90
DN-129/8S	17,5	51	DN-129/8S+TV	20,5	51
DN-129/8D	23,0	102	DN-129/8D+TV	26,0	102
DN-129/9S	19,5	58	DN-129/9S+TV	22,5	58
DN-129/9D	25,5	115	DN-129/9D+TV	28,5	115
DN-129/10S	21,5	64	DN-129/10S+TV	24,0	64
DN-129/10D	28,0	128	DN-129/10D+TV	31,0	128

2.3. Dimensions and mounting of the displays

2.3.1. Dimensions and mounting of the DN-109 and DN-119

Reference	A	B	Reference	A	B
DN-109/3S	288	122	DN-109/3S+T	288	122
DN-109/4S	288	122	DN-109/4S+T	336	122
DN-109/5S	288	122	DN-109/5S+T	382	122
DN-109/6S	336	122	DN-109/6S+T	430	122
DN-109/7S	382	122	DN-109/7S+T	478	122
DN-109/8S	430	122	DN-109/8S+T	526	122
DN-109/9S	478	122	DN-109/9S+T	574	122
DN-109/10S	526	122	DN-109/10S+T	622	122
DN-119/3S	324	177	DN-119/3S+T	504	177
DN-119/4S	414	177	DN-119/4S+T	594	177
DN-119/5S	504	177	DN-119/5S+T	684	177
DN-119/6S	594	177	DN-119/6S+T	774	177
DN-119/7S	684	177	DN-119/7S+T	864	177
DN-119/8S	774	177	DN-119/8S+T	954	177
DN-119/9S	864	177	DN-119/9S+T	1044	177
DN-119/10S	954	177	DN-119/10S+T	1134	177

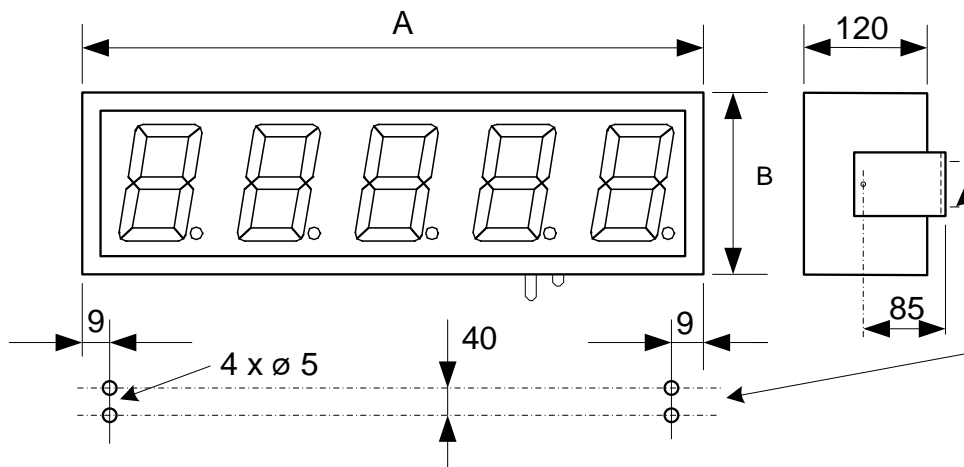

2.3.2. Dimensions and mounting of the DN-129 and DN-189

Reference	A	B	C	Reference	A	B	C
DN-189/2S	340	251	67	DN-189/2S+TV	660	251	67
DN-189/3S	500	251	67	DN-189/3S+TV	820	251	67
DN-189/4S	660	251	67	DN-189/4S+TV	980	251	67
DN-189/5S	820	251	67	DN-189/5S+TV	1140	251	67
DN-189/6S	980	251	67	DN-189/6S+TV	1300	251	67
DN-189/7S	1140	251	67	DN-189/7S+TV	1460	251	67
DN-189/8S	1300	251	67	DN-189/8S+TV	1620	251	67
DN-189/9S	1460	251	67	DN-189/9S+TV	1780	251	67
DN-189/10S	1620	251	67	DN-189/10S+TV	1940	251	67
DN-129/2S	515	366	186	DN-129/2S+TV	985	366	186
DN-129/3S	750	366	186	DN-129/3S+TV	1220	366	186
DN-129/4S	985	366	186	DN-129/4S+TV	1455	366	186
DN-129/5S	1220	366	186	DN-129/5S+TV	1690	366	186
DN-129/6S	1455	366	186	DN-129/6S+TV	1925	366	186
DN-129/7S	1690	366	186	DN-129/7S+TV	2160	366	186
DN-129/8S	1925	366	186	DN-129/8S+TV	2395	366	186
DN-129/9S	2160	366	186	DN-129/9S+TV	2630	366	186
DN-129/10S	2395	366	186	DN-129/10S+TV	2865	366	186

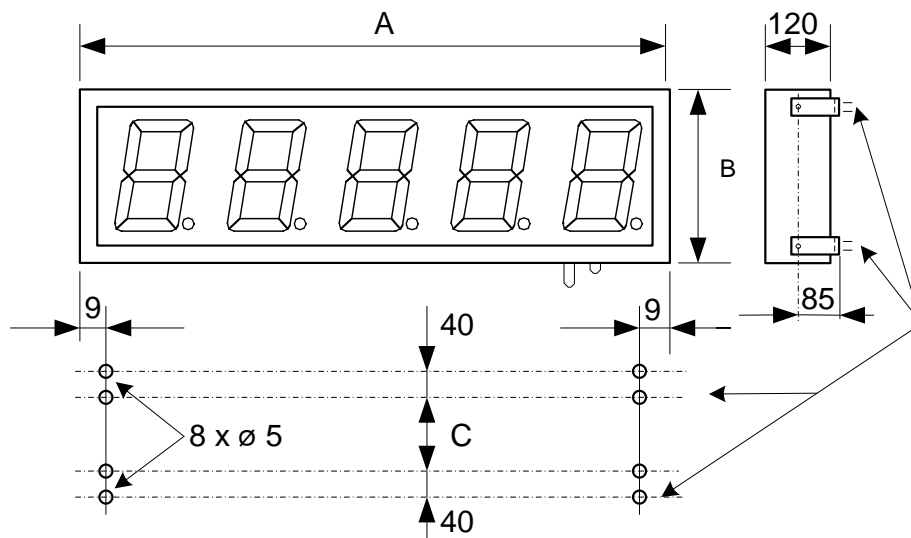

3. INSTALLATION

The installation of the DN-109NW, DN-119NW, DN-129NW and DN-189NW is not particularly delicate but some important considerations must be taken into account.

The display must not be anchored to places subject to vibrations, nor should it be installed in places which generally surpass the limits specified in the display characteristics, both in terms of temperature and humidity.

The degree of protection of displays DN-109NW, DN-119NW, DN-129NW and DN-189NW is IP41, meaning that they are protected against penetration by solid foreign objects of a diameter of about 1mm and against the vertical fall of water droplets.

Displays DN-109NW, DN-119NW, DN-129NW and DN-189NW should not be installed in places with an illumination level in excess of 1000 lux. Neither should the display be placed in direct sunlight as visibility would be lost.

In the electrical installation, proximity to lines of high intensity circulation and high voltage lines must be avoided, as well as proximity to High Frequency generators and U/F converters for motors.

3.1. Power supply.

The power supply must be 88 to 264VAC, 47 to 63 Hz or 24VDC.

The power supply conductor section will be in line with consumption and the ground conductor will be a minimum section of 1.5m².

The power supply connector for 220VAC has 3 contacts and is situated in the lower part of the unit. Connect the power wires following the schema below

The power supply connector for 24VDC has 4 contacts and is situated in the lower part of the unit. Connect the power wires following the schema below

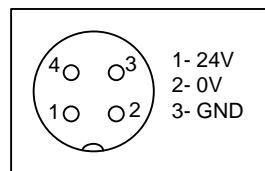
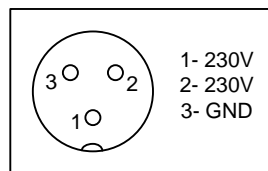

3.2. Connecting the antenna

Wifi connection is carried out using an antenna located in the lower part of the unit.



4. OPERATION

4.1. Initial reset.

Before connecting the display to the network, we must ensure that all of the connections have been carried out correctly and that the display is firmly in place.

Each time we connect the display to the power supply network, an initial reset occurs which tests all of the segments comprising the display. The test consists of the sequential illumination of all of the digits with the number "8", all of the digits with the value "0", all of the decimal points are lit up and finally the version code. From this point any one of the following three situations may occur:

- a) The display receives data from the Wifi network and displays it.
- b) The display does not receive data and the time without data equals zero. Continues to show the decimal points.
- c) The display does not receive data and the time without data is not equal to zero. After a time without data it displays a dash in each digit.

4.2. Programming parameters.

Displays DN-109NW, DN-119NW, DN-129NW and DN-189NW can be adapted to the specifications of each client by the programming of parameters. The parameters which can be configured are:

- 1- Protocol.
- 2- End of block code
- 3- Time without receiving data
- 4- Reply Message
- 5- Unit MAC code
 - 6- Load the default configuration to the Ethernet port
 - 7- Set up IP address using serial line.
 - 8- To exit modify parameters

To program the parameters, the digits on the right of the display are used. The number of the parameter is indicated by the digit on the left and the decimal point flashes while the digit on the right is off.

4.2.1. Enter to modify parameters.

In order to enter the sequence to modify the parameters, the Advance key “*” must be pressed and held for three seconds. After this, the first parameters will be displayed, showing the most significant digit flashing.

There are then two options:

1- Modify the parameter value

By pressing the Advance key “*”, entry is gained to modify the parameter value.

To go back to displaying the parameter number, press “*” again.

To increase the parameter value, press the “+” key. After parameter 7 it returns to 1.

2- Select another parameter

In order to select another parameter, the parameter number must be made to flash using the “*” key and then the new parameter may be selected using the “+” key.

4.2.2. Exit modify parameters.

In order to exit the sequence for modifying parameters, parameter 8 must be selected. Then press “*”.

4.2.3. Function of each parameter.

4.2.3.1. Parameter 1: Protocol

0 = Protocols TCP/IP and UDP/IP

1 = Protocol Modbus/TCP

4.2.3.2. Parameter 2: End of Block. Only TCP/IP and UDP/IP protocols

Allows for code selection to indicate that the block has been completely sent.

Value	End of block	
0	CR	0Dh
1	CR	0Ah
2	CR LF	0Dh 0Ah
3	LF CR	0Ah 0Dh
4		03h
5		02h
6	* CR	2Ah 0Dh
7		04h

4.2.3.3. Parameter 3: Time without receiving data

This parameter allows the programming of a time to warn that it is not receiving data or that the data is incorrect. The warning occurs if the programmed time is exceeded.

Each time that a communication is received correctly, the time is reset to zero. The code "00" (No time) does not trigger any warning.

To indicate that the time limit has been exceeded, a dash will be displayed on each digit.

Code	Time	Code	Time
00	No time	11	1 min.
01	2 s	12	2 min.
02	4 s	13	5 min.
03	6 s	14	10 min.
04	8 s	15	20 min.
05	10 s	16	40 min.
06	14 s	17	1 hour.
07	20 s	18	2 hours.
08	26 s	19	5 hours.
09	30 s	20	10 hours.
10	40 s	21	25 hours.

4.2.3.4. Parameter 4: Response Message. Only TCP/IP and UDP/IP protocols

For configuring the display's response message.

Value	Response message
0	Without response
1	06h + End of block
2	ACK + End of Block
3	06h
4	ACK

The end of block is the one selected in parameter 3.

If value 1 has been selected, the 06h code is sent, followed by the block selected in parameter 2

If value 2 has been selected, the ACK characters are sent followed by the block selected in parameter 2.

4.2.3.5. Parameter 5: MAC

The MAC code is a code which identifies each port which connects to an Ethernet network. It is unique to each unit and is needed to configure the port.

The MAC code is formed by 6 bytes in a hexadecimal format. The 3 bytes on the left are always the same for units DN-109NE/DN-119NE /DN-129NE/DN-189NE.

This parameter allows you to ascertain the 3 bytes on the right. In order to identify them, a decimal point is used. Byte 4 has the point of the right digit activated. Byte 5 has the point of the left digit activated. Byte 6 has both points activated.

Byte 1	Byte 2	Byte 3	Byte 4	Byte 5	Byte 6
00h	20h	4Ah			
			XX.	X.X	X.X.

4.2.3.6. Parameter 6: Load the default configuration to the port

If the configuration of the port has been modified and the factory parameters cannot be reset, this parameter can be used to load them.

To load the factory parameters, value 99 must be input and the advance key “*” pressed. During the parameter loading time, the three digits are displayed flashing. When finished, parameter 6 is displayed.

4.2.3.7. Parameter 7: Set up IP using serial line.

In order to set up the IP address you must use the serial line and a computer with the Hyperterminal. See 4.4 “IP address”.

4.2.3.8. Parameter 8:

Exit modify parameters

Push the key “*” to exit the option modify parameters. Before exiting the parameters are saved.

Push the key “+” until reaching the parameter to be modified to keep on modifying parameters.

4.3. Protocols

In this paragraph, the different protocols will be explained, as well as the programming of the displays through them. The formats of values of the numbers and characters are written in this manual are:

- When telling about a hexadecimal number, this will be followed by an “h”.
- When telling about a decimal number, this will be followed by a “d”.
- When telling about a binary number, this will be followed by a “b”.
- When telling about an ASCII character, this will be explained in the context.

As an example, the X ASCII character can be explained as 58h, 88d or 1011000b, as needed in the moment. Number 15 ASCII can be seen as 31h 35h, 49d 53d or 110001d 110101d.

4.3.1. TCP/IP Protocol

In order to use TCP/IP and Modbus/TCP protocols, the communication port must be programmed with the default configuration. See 4.2.3.6 “Parameter 6: Load the default configuration to the port”.

In order for the display to be able to accept a block, it must end with an end of block that is recognised by the display. The end of block coding which the display expects to receive can be found in 4.2.3.2 “Parameter 2:End of Block. Only TCP/IP and UDP/IP protocols”

**The last character sent is displayed on the right of the display.
Port 10001 must be used.**

4.3.2. Modbus/TCP Protocol

End of block not necessary.

**The last character sent is displayed on the right of the display.
Port 502 must be used.**

The data block transmitted must have the following values:

Byte 6. Slave ID = 01h.

Byte 7. Function Code = 16(10h)

Byte 8 and 9. Start address = 00h 00h.

4.3.2.1. Valid characters.

The characters allowed are:

Character	0	1	2	3	4	5	6	7	8	9	A	b
HEXA	30h	31h	32h	33h	34h	35h	36h	37h	38h	39h	41h	42h
DEC	48d	49d	50d	51d	52d	53d	54d	55d	56d	57d	65d	66d

Character	C	c	d	E	F	H	h	i	J	L	n	o
HEXA	43h	63h	64h	45h	46h	48h	68h	69h	4Ah	4Ch	6Eh	6Fh
DEC	67d	99d	100d	69d	70d	72d	104d	105d	74d	76d	110d	111d

Character	P	r	U	u	,	.	-	_	'	-		
HEXA	50h	72h	55h	75h	20h	2Ch	2Eh	2Dh	16h	27h	28h	
DEC	80d	114d	85d	117d	32d	44d	46d	45d	22d	39d	40d	

Beginning and ending of **flashing** code are used to set in flashing a character, several characters or all characters. Beginning of flashing code must be set before the first character in flashing and the end of flashing code must be set after the last character in flashing

- 08h: Begin of flashing characters
- 09h: End of flashing characters

Example:

On a 6-digit display to display: 123456 with digits 3 and 4 flashing.

In ASCII code the following must be sent: "1" "2" 08h "3" "4" 09h "5" "6" + end of block.

In hexa. code the following must be sent: 31h 32h 08h 33h 34h 09h 35h 36h + end of block.

4.4. IP address

The easiest way to set up the IP address is by using the Hyperterminal program and the serial line of computer. The cable's wiring diagram is the classic crossover.

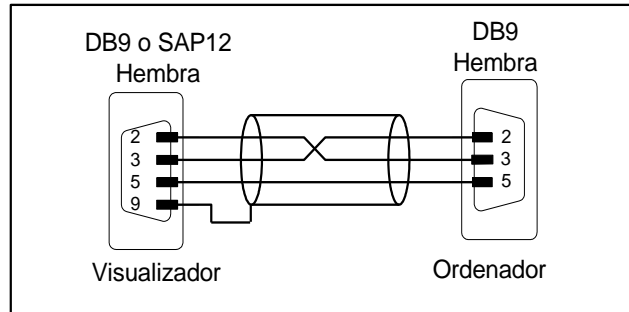

The configuration of the Hypoerterminal must be:

- Baud rate: 9600 Bauds
- Data Bits: 8
- No parity
- Stop Bits: 1
- Hardware flow control: None.

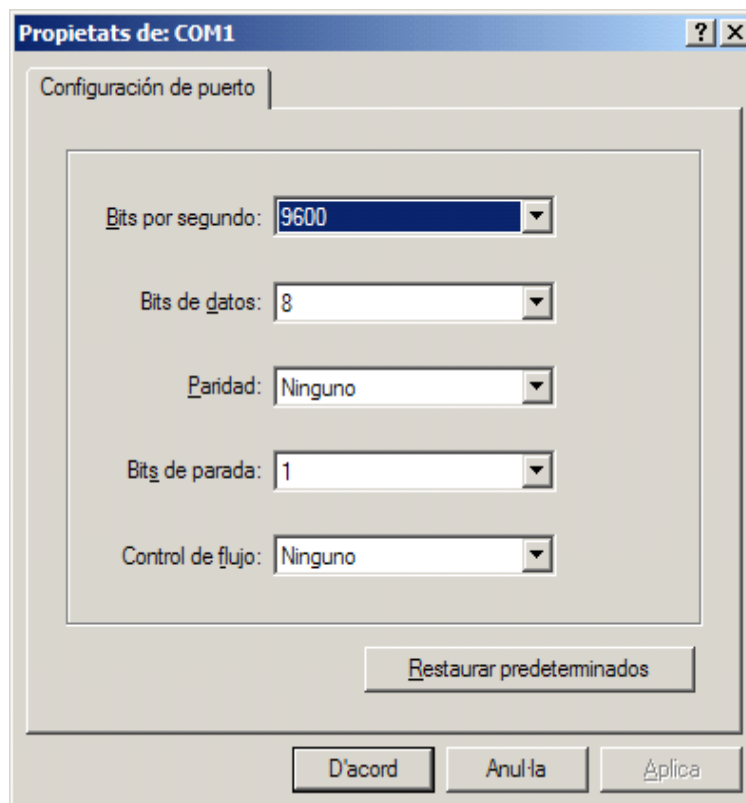

The attached Hyperterminal set up have been verified and work correctly, but any other set up may work also correctly.

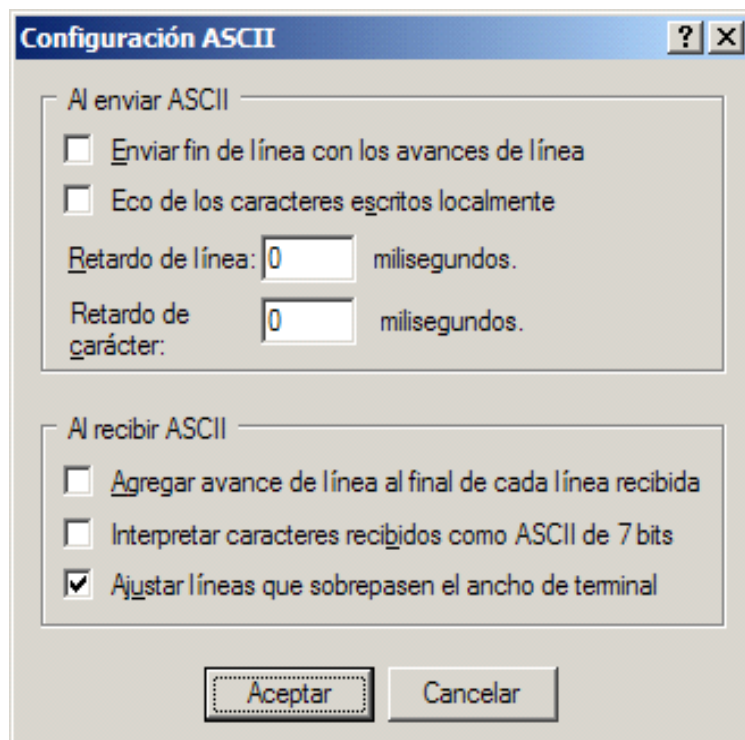
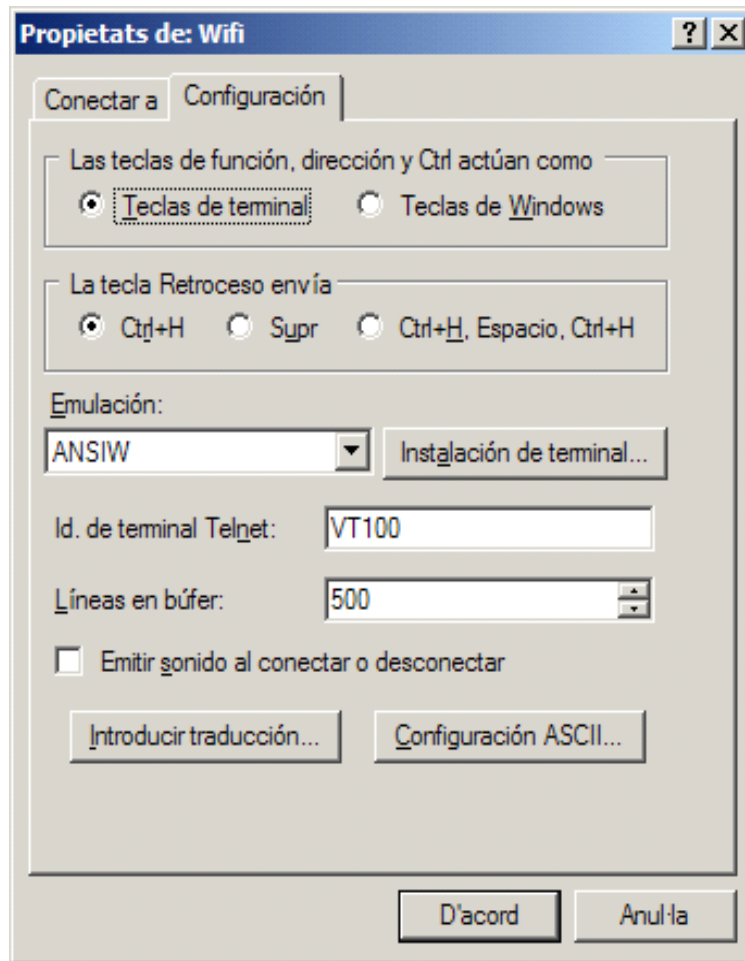

To set up the Wifi module using the Hyperterminal or any other program, you must follow a time sequence. A time error on steps 5 and 6 forces to return to step 3.

4.4.1. Accessing Wifi module configuration

In order to access to Wifi module configuration the next steps must be followed:

1– Connect the serial cable (see 4.4 “IP address”) between the computer and the display.

2– Open Hyperterminal.

3– Select the display’s parameter 7. See 4.2.3.7 Parameter 7: Set up IP using serial line.

4– Push the advance key. (Key *)

5– Keep pushed the lower case letter x before the display counters equals 0. Remain pushing until the following screen is displayed.

The maximum delay since to push the advance key (step 4) until to push x key is 10 seconds.

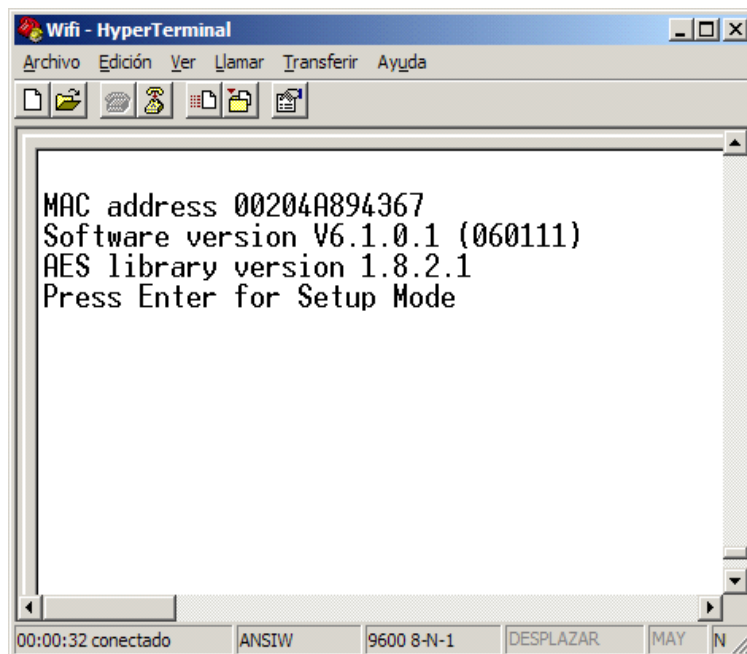

- 6– At this time you have **3 seconds** to push the Intro key on your keyboard .
7– The following screen is shown.

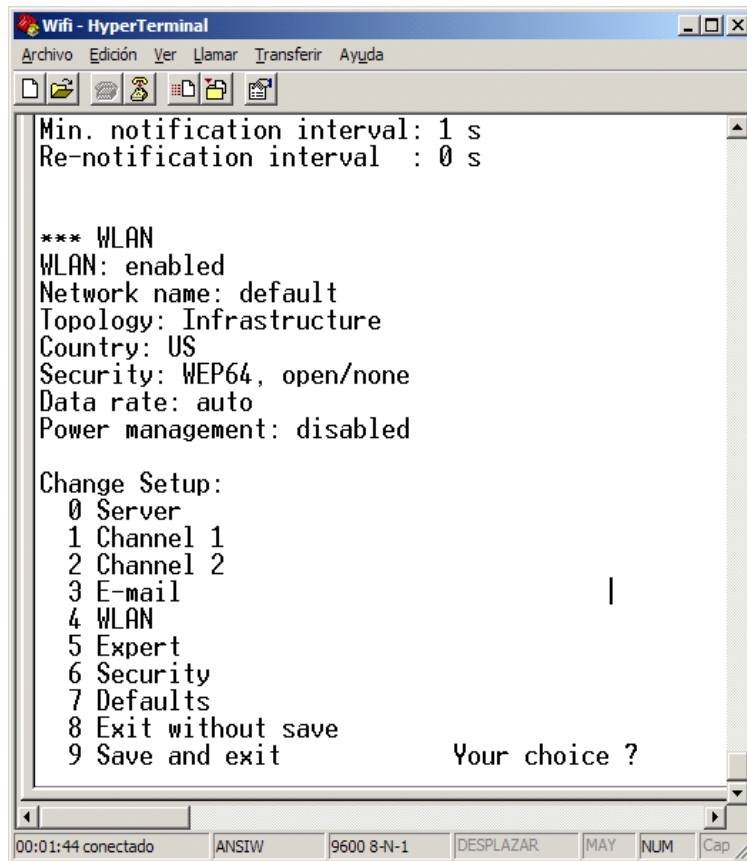

```
Wifi - HyperTerminal
Archivo Edición Ver Llamar Transferir Ayuda
Min. notification interval: 1 s
Re-notification interval : 0 s

*** WLAN
WLAN: enabled
Network name: default
Topology: Infrastructure
Country: US
Security: WEP64, open/none
Data rate: auto
Power management: disabled

Change Setup:
 0 Server
 1 Channel 1
 2 Channel 2
 3 E-mail
 4 WLAN
 5 Expert
 6 Security
 7 Defaults
 8 Exit without save
 9 Save and exit          Your choice ?

00:01:44 conectado ANSIW 9600 8-N-1 DESPLAZAR MAY NUM Cap
```

8- You must set up:

0 Server + Intro

4 WLAN + Intro

Example of Server Set up

Ask your network administrator the IP and Gateway address.

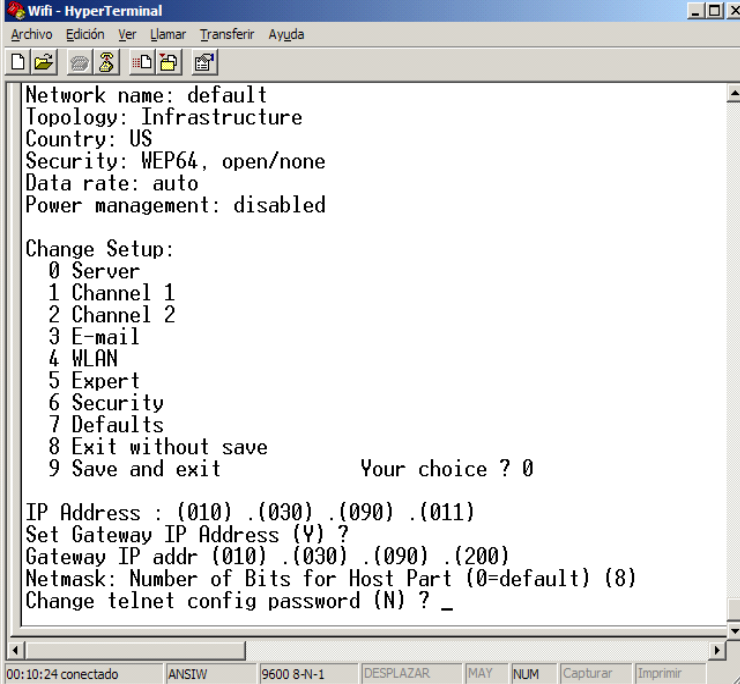

```

Wifi - HyperTerminal
Archivo Edición Ver Llamar Transferir Ayuda
[Icons]
Network name: default
Topology: Infrastructure
Country: US
Security: WEP64, open/none
Data rate: auto
Power management: disabled

Change Setup:
0 Server
1 Channel 1
2 Channel 2
3 E-mail
4 WLAN
5 Expert
6 Security
7 Defaults
8 Exit without save
9 Save and exit          Your choice ? 0

IP Address : (010) .(030) .(090) .(011)
Set Gateway IP Address (Y) ?
Gateway IP addr (010) .(030) .(090) .(200)
Netmask: Number of Bits for Host Part (0=default) (8)
Change telnet config password (N) ? _

00:10:24 conectado ANSIV 9600 8-N-1 DESPLAZAR MAY NUM Capturar Imprimir

```

Example of WLAN Set up

Ask your network administrator the correct values

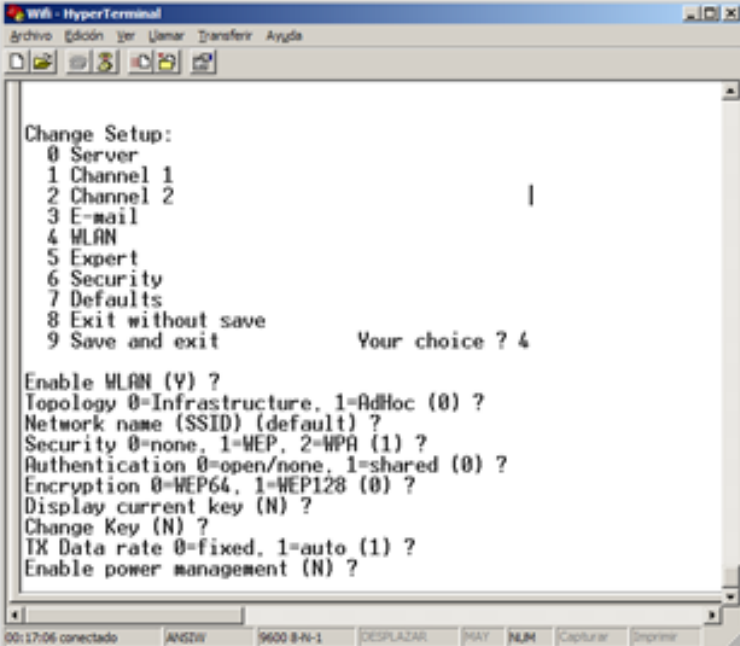

```

Wifi - HyperTerminal
Archivo Edición Ver Llamar Transferir Ayuda
[Icons]
Change Setup:
0 Server
1 Channel 1
2 Channel 2
3 E-mail
4 WLAN
5 Expert
6 Security
7 Defaults
8 Exit without save
9 Save and exit          Your choice ? 4

Enable WLAN (Y) ?
Topology 0=Infrastructure, 1=AdHoc (0) ?
Network name (SSID) (default) ?
Security 0=none, 1=WEP, 2=WPA (1) ?
Authentication 0=open/none, 1=shared (0) ?
Encryption 0=WEP64, 1=WEP128 (0) ?
Display current key (N) ?
Change Key (N) ?
TX Data rate 0=fixed, 1=auto (1) ?
Enable power management (N) ?

00:17:06 conectado ANSIV 9600 8-N-1 DESPLAZAR MAY NUM Capturar Imprimir

```

To exit select 8 (Exit without save) or 9 (Save and exit).

4.5. Set up IP Address using the DeviceInstaller.

Before being able to communicate with the display an IP address must be assigned. To assign an IP address the DeviceInstaller program from Lantronix must be used, which can be downloaded free from their website: www.lantronix.com

Select: Support → Technical Support → Firmware/Downloads.

Select: DeviceInstaller.

Once the program is installed and running, press the “Search” button to locate the connected displays. The display must be turned on and connected to the network.

If there are no network problems, a screen similar to this should be displayed.

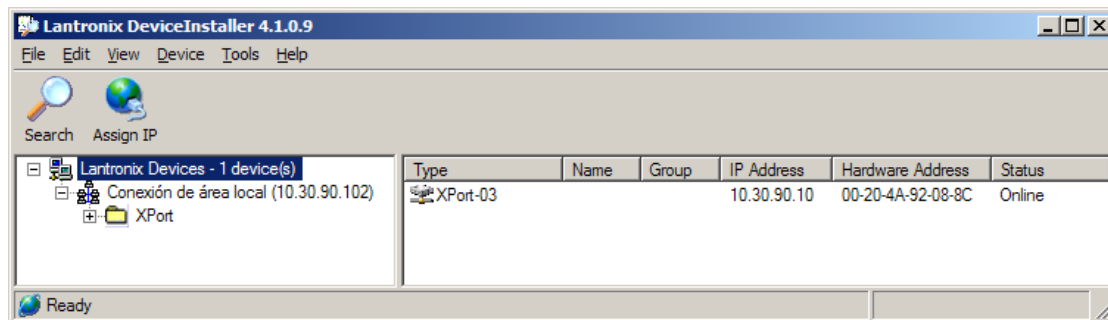

The IP address with which the equipment is supplied is: 10.30.90.10

The Hardware Address is the unit MAC code.

To assign the IP address you must first select the equipment by clicking on the XPort-03 to which you wish to assign the address. Then press Assign IP and follow the instructions.

IMPORTANT: All units are dispatched from the factory with the same IP address. Therefore to configure various units, they must be connected to the Ethernet and the address must be assigned one by one.

4.6. Modifying the port settings.

To modify the port configuration the DeviceInstaller program from Lantronix must be used, which can be downloaded free from their website: www.lantronix.com

Select: Support → Technical Support → Firmware/Downloads.

Select: DeviceInstaller.

Once the program is installed and running, press the “Search” button to locate the connected displays. The display must be turned on and connected to the network.

If there are no network problems, the same screen for configuring an IP address should be displayed. See 4.5 “Set up IP Address using the DeviceInstaller.”

To access the setup you must first select the unit clicking on the XPort-03 that you wish to modify.

Revision history

Revision C (March 2013).

Updated introduction in 4.4.

Revision D (September 2013).

Updated dimensions and weight of DN-109/3. Paragraphs 2.2.1 and 2.3.1.

STATEMENT OF CONFORMITY



DISEÑOS Y TECNOLOGIA, S.A.
Poligon Industrial Les Guixeres
C/ Xarol 8C
08915 BADALONA España

As the builder of the equipment of the **DITEL** brand:

Model : DN-109NW in all versions.
Model : DN-119NW in all versions.
Model : DN-129NW in all versions.
Model : DN-189NW in all versions.

We declare under our sole responsibility that the aforementioned product complies with the following European directives:

Directive: LVD 2006/95/CEE Low Voltage Directive.
Standard UNE-EN61010-1 Security in electric equipment.

Directive: EMC 2004/108/CEE Electromagnetic Compatibility
Standard UNE-EN 61000-6-4 Generic Emission Standard. Industrial environment.
Standard UNE-EN 61000-6-2 Generic Immunity Standard. Industrial environment.

Badalona, 5th February 2013

A handwritten signature in black ink, appearing to read 'Alicia Alarcia', is centered below the date.

Alicia Alarcia
Technical Director