

**OPERATIONAL MANUAL FOR PROFINET
DISPLAY SERIES**

DT-203NN, DT-105NN AND DT-110NN

Index

Index.....	1-1
1 INTRODUCTION	1-2
2 GENERAL CHARACTERISTICS.....	2-1
2.1 Electrical characteristics of the displays	2-1
2.1.1 Electrical characteristics of the DT-203 displays.....	2-1
2.1.2 Electrical characteristics of the DT-105 displays.....	2-1
2.1.3 Electrical characteristics of the DT-110 displays.....	2-1
2.2 Weight and power consumption. Exterior option use column h(VA)	2-2
2.3 Dimensions of the DT-203, DT-105 and DT-110.....	2-4
3 INSTALLATION	3-1
3.1 Equipment interfaces.....	3-1
3.2 Power supply.....	3-2
3.3 Wire for the transfer of messages to the display memory.....	3-2
3.4 Characteristics of temperature & humidity probe. (Option)	3-3
3.5 Wiring of temperature & humidity probe (Option).....	3-3
3.6 Reset button	3-3
3.7 IP65 Profinet connectors installation.....	3-4
3.7.1 IP65 Profinet conection	3-4
3.7.2 DB-9 connector with cover (TDL).....	3-5
4 OPERATION.....	4-1
4.1 Initial Start Up.....	4-1
4.2 Programming parameters.....	4-1
4.2.1 Enter to modify parameters.....	4-1
4.2.2 Quit parameter configuration.....	4-1
4.2.3 Parameter description.....	4-2
5 PROTOCOL AND OPERATIONAL WORK	5-1
5.1 PROFINET protocol.....	5-2
5.1.1 Before configuring.....	5-2
5.1.2 Download GSD file.....	5-3
5.1.3 Creating a GSD custom file.....	5-3
5.1.4 Display installation in TIA Portal V13	5-7
5.2 Operational modes	5-10
5.2.1 Code selecting.....	5-10
5.2.2 Control by direct message.....	5-12
5.2.3 Special commands	5-14
5.2.4 Status LEDs	5-15

1 INTRODUCTION

The alphanumerical displays series **DT-203NN**, **DT-105NN** and **DT-110NN**, are industrial displays controlled by Profinet network.

One of its main characteristics is the height of the characters:

- DT-203NN: 30mm**, readable from up to 15m.
- DT-105NN: 50mm**, readable from up to 25m.
- DT-110NN: 100mm**, readable from up to 50m

As with other display series, the **DT-NN** is available in one or two-sided versions, which provides multiple solutions and installation possibilities.

It can be surface mounted or suspended using the side anchoring.

The application field of these displays is very wide in all types of industrial applications using the advantages of the Profinet network. They can be used to display Scada program values, counter values from a PLC, warning messages, advertisements....

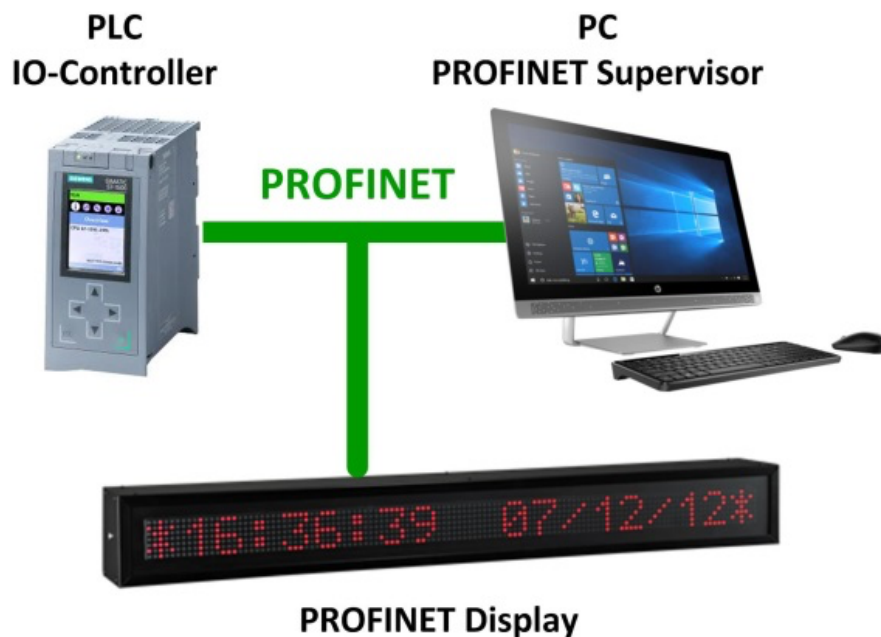

Fig. 1 Profinet communication

2 GENERAL CHARACTERISTICS.

2.1 Electrical characteristics of the displays

2.1.1 Electrical characteristics of the DT-203 displays.

Supply Voltage	100 to 240 VAC 50/60Hz or 24VDC option.
Consumption	See section 2.2.
Display	7x5 Dot matrix of 30mm high.
.....	Red Led colour. Visibility 15 meters.
Parameter memory	Eeprom.
Watch calendar	Second / Minute / Hour / Day / Month / Year.
Environmental Conditions	Operation Temperature: -20 to 60°C.
.....	Storage temperature: -30°C to 70°C.
.....	Humidity: 20-90% without condensation.
.....	Maximum environmental illumination: 1000 lux.
.....	Sealing: IP41, IP54 and IP65.

2.1.2 Electrical characteristics of the DT-105 displays.

Supply Voltage	100 to 240 VAC 50/60Hz or 24VDC option.
Consumption	See section 2.2.
Display	7x5 Dot matrix of 50mm high.
.....	Red Led colour. Visibility 25 meters.
Parameter memory	Eeprom.
Watch calendar	Second / Minute / Hour / Day / Month / Year.
Environmental Conditions	Operation Temperature: -20 to 60°C.
.....	Storage temperature: -30°C to 70°C.
.....	Humidity: 20-90% without condensation.
.....	Maximum environmental illumination: 1000 lux.
.....	Sealing: IP41, IP54 and IP65.

2.1.3 Electrical characteristics of the DT-110 displays.

Supply Voltage	100 to 240 VAC 50/60Hz or 24VDC option.
Consumption	See section 2.2.
Display	7x5 Dot matrix of 100mm high.
.....	Red Led colour. Visibility 50 meters.
Parameter memory	Eeprom.
Watch calendar	Second / Minute / Hour / Day / Month / Year.
Environmental Conditions	Operation Temperature: -20 to 60°C.
.....	Storage temperature: -30°C to 70°C.
.....	Humidity: 20-90% without condensation.
.....	Maximum environmental illumination: 1000 lux.
.....	Sealing: IP41, IP54 and IP65.

2.2 Weight and power consumption. Exterior option use column h(VA)

Reference	Weight (kg)	Power (VA)	Power h (VA)	Reference	Weight (kg)	Power (VA)	Power h (VA)
DT-105/1S-6	4,5	17	30	DT-110/1S-6	7	17	30
DT-105/1D-6	4,5	21	51	DT-110/1D-6	8	21	51
DT-105/1S-13	6	21	51	DT-110/1S-13	11	21	51
DT-105/1D-13	6,5	33	95	DT-110/1D-13	13,5	33	95
DT-105/1S-20	7,5	27	73	DT-110/1S-20	15	27	73
DT-105/1D-20	8,5	43	139	DT-110/1D-20	18,5	43	139
DT-105/1S-26	9,5	33	95	DT-110/1S-26	19,5	33	95
DT-105/1D-26	10,5	55	184	DT-110/1D-26	24	55	184
DT-105/1S-33	11	39	117	DT-110/2S-6	9,5	21	53
DT-105/1D-33	12,5	65	227	DT-110/2D-6	12	33	95
DT-105/1S-40	12,5	43	141	DT-110/2S-13	15,5	33	95
DT-105/1D-40	14,5	77	271	DT-110/2D-13	20,5	55	183
DT-105/2S-6	5,5	21	53	DT-110/2S-20	21,5	43	139
DT-105/2D-6	6	33	95	DT-110/2D-20	28,5	77	271
DT-105/2S-13	7,5	33	95	DT-110/2S-26	27,5	55	185
DT-105/2D-13	8,5	55	183	DT-110/2D-26	37	97	359
DT-105/2S-20	9,5	43	139	DT-110/3S-6	12,5	27	73
DT-105/2D-20	11	77	271	DT-110/3D-6	16	43	117
DT-105/2S-26	11,5	55	185	DT-110/3S-13	20,5	43	141
DT-105/2D-26	14	97	359	DT-110/3D-13	27,5	77	249
DT-105/2S-33	14	65	225	DT-110/3S-20	28	60	205
DT-105/2D-33	16,5	120	447	DT-110/3D-20	39	110	381
DT-105/2S-40	16	77	271	DT-110/3S-26	36	77	271
DT-105/2D-40	19,5	143	535	DT-110/3D-26	50	143	515
DT-105/3S-6	6	27	73	DT-110/4S-6	15	32	95
DT-105/3D-6	7	43	117	DT-110/4D-6	20	54	154
DT-105/3S-13	9	43	141	DT-110/4S-13	25	54	186
DT-105/3D-13	10,5	77	249	DT-110/4D-13	34,5	99	330
DT-105/3S-20	11,5	60	205	DT-110/4S-20	34,5	77	273
DT-105/3D-20	14	110	381	DT-110/4D-20	49	143	491
DT-105/3S-26	14	77	271	DT-110/5S-6	18	37	117
DT-105/3D-26	17,5	143	515	DT-110/5D-6	24	65	187
DT-105/3S-33	16,5	95	337	DT-110/5S-13	30	65	231
DT-105/3D-33	21	175	645	DT-110/5D-13	41,5	121	407
DT-105/3S-40	19	110	405	DT-110/5S-20	41,5	93	335
DT-105/3D-40	24,5	210	775	DT-110/5D-20	58,5	175	605
DT-105/4S-6	7	32	95	DT-110/6S-6	20,5	42	138
DT-105/4D-6	8,5	54	154	DT-110/6D-6	28	76	220
DT-105/4S-13	11	54	186	DT-110/6S-13	34,5	76	276
DT-105/4D-13	12,5	99	330	DT-110/6D-13	48,5	143	484
DT-105/4S-20	13	77	273	DT-110/6S-20	48	110	405
DT-105/4D-20	16,5	143	491	DT-110/6D-20	69	209	705
DT-105/5S-6	7,5	37	117	DT-110/7S-6	23,5	47	160
DT-105/5D-6	9,5	65	187	DT-110/7D-6	32	87	253
DT-105/5S-13	12,5	65	231	DT-110/7S-13	39,5	87	321
DT-105/5D-13	14,5	121	407	DT-110/7D-13	55,5	165	561
DT-105/5S-20	15	93	335	DT-110/8S-6	26	52	181

Reference	Weight (kg)	Power (VA)	Power h (VA)	Reference	Weight (kg)	Power (VA)	Power h (VA)
DT-105/5D-20	19	175	605	DT-110/8D-6	36	98	286
DT-105/6S-6	8,5	42	138	DT-110/8S-13	44	98	365
DT-105/6D-6	11	76	220	DT-110/8D-13	62,5	187	638
DT-105/6S-13	14	76	276	DT-203/2S-20	6,5	40	----
DT-105/6D-13	16,5	143	484	DT-203/2D-20	7	65	----
DT-105/6S-20	17	110	405	DT-203/2S-40	9,5	65	----
DT-105/6D-20	22	209	705	DT-203/2D-40	11	125	----
DT-105/7S-6	9	47	160	DT-203/4S-20	8	65	----
DT-105/7D-6	12	87	253	DT-203/4D-20	9,5	125	----
DT-105/7S-13	15	87	321	DT-203/4S-40	12,5	125	----
DT-105/7D-13	18,5	165	561	DT-203/4D-40	15,5	245	----
DT-105/8S-6	10	52	181	DT-203/6S-20	9,5	95	----
DT-105/8D-6	13,5	98	286	DT-203/6D-20	12	185	----
DT-105/8S-13	16,5	98	365	DT-203/8S-20	11,5	125	----
DT-105/8D-13	20,5	187	638	DT-203/8D-20	14,5	245	----

2.3 Dimensions of the DT-203, DT-105 and DT-110

	A	B	C	D	E	F	G	P1	P2	P3
DT-105/1S(D)-6	375	118	109	X	X	X	358	O	X	X
DT-105/1S(D)-13	680	118	109	X	X	X	663	O	X	X
DT-105/1S(D)-20	985	118	109	X	X	X	968	O	X	X
DT-105/1S(D)-26	1290	118	109	X	X	X	1273	O	X	X
DT-105/1S(D)-33	1595	118	109	X	X	X	1578	O	X	X
DT-105/1S(D)-40	1900	118	109	X	X	X	1883	O	X	X
DT-105/2S(D)-6	375	230	112	X	X	X	358	O	X	X
DT-105/2S(D)-13	680	230	112	X	X	X	663	O	X	X
DT-105/2S(D)-20	985	230	112	X	X	X	968	O	X	X
DT-105/2S(D)-26	1290	230	112	X	X	X	1273	O	X	X
DT-105/2S(D)-33	1595	230	112	X	X	X	1578	O	X	X
DT-105/2S(D)-40	1900	230	112	X	X	X	1883	O	X	X
DT-105/3S(D)-6	375	338	X	72	186	X	358	X	O	O
DT-105/3S(D)-13	680	338	X	72	186	X	663	X	O	O
DT-105/3S(D)-20	985	338	X	72	186	X	968	X	O	O
DT-105/3S(D)-26	1290	338	X	72	186	X	1273	X	O	O
DT-105/3S(D)-33	1595	338	X	72	186	X	1578	X	O	O
DT-105/3S(D)-40	1900	338	X	72	186	X	1883	X	O	O
DT-105/4S(D)-6	375	436	X	72	292	X	358	X	O	O
DT-105/4S(D)-13	680	436	X	72	292	X	663	X	O	O
DT-105/4S(D)-20	985	436	X	72	292	X	968	X	O	O
DT-105/5S(D)-6	375	542	X	92	358	X	358	X	O	O
DT-105/5S(D)-13	680	542	X	92	358	X	663	X	O	O
DT-105/5S(D)-20	985	542	X	92	358	X	968	X	O	O
DT-105/6S(D)-6	375	648	X	112	424	X	358	X	O	O
DT-105/6S(D)-13	680	648	X	112	424	X	663	X	O	O
DT-105/6S(D)-20	985	648	X	112	424	X	968	X	O	O
DT-105/7S(D)-6	375	754	377	72	610	305	358	O	O	O
DT-105/7S(D)-13	680	754	377	72	610	305	663	O	O	O
DT-105/8S(D)-6	375	860	430	72	716	358	358	O	O	O
DT-105/8S(D)-13	680	860	430	72	716	358	663	O	O	O
DT-110/1S(D)-6	666	177	82,5	X	X	X	649	O	X	X
DT-110/1S(D)-13	1276	177	82,5	X	X	X	1259	O	X	X
DT-110/1S(D)-20	1886	177	82,5	X	X	X	1869	O	X	X
DT-110/1S(D)-26	2496	177	82,5	X	X	X	2479	O	X	X
DT-110/2S(D)-6	666	378	X	80	218	X	649	X	O	O
DT-110/2S(D)-13	1276	378	X	80	218	X	1259	X	O	O
DT-110/2S(D)-20	1886	378	X	80	218	X	1869	X	O	O
DT-110/2S(D)-26	2496	378	X	80	218	X	2479	X	O	O
DT-110/3S(D)-6	666	591	X	80	430	X	649	X	O	O
DT-110/3S(D)-13	1276	591	X	80	430	X	1259	X	O	O
DT-110/3S(D)-20	1886	591	X	80	430	X	1869	X	O	O
DT-110/3S(D)-26	2496	591	X	80	430	X	2479	X	O	O
DT-110/4S(D)-6	666	805	403	80	646	322,5	649	O	O	O
DT-110/4S(D)-13	1276	805	403	80	646	322,5	1259	O	O	O
DT-110/4S(D)-20	1886	805	403	80	646	322,5	1869	O	O	O
DT-110/5S(D)-6	666	1018	509	80	858	429	649	O	O	O
DT-110/5S(D)-13	1276	1018	509	80	858	429	1259	O	O	O

	A	B	C	D	E	F	G	P1	P2	P3
DT-110/5S(D)-20	1886	1018	509	80	858	429	1869	O	O	O
DT-110/6S(D)-6	666	1232	616	80	1072	536	649	O	O	O
DT-110/6S(D)-13	1276	1232	616	80	1072	536	1259	O	O	O
DT-110/6S(D)-20	1886	1232	616	80	1072	536	1869	O	O	O
DT-110/7S(D)-6	666	1445	723	80	1286	643	649	O	O	O
DT-110/7S(D)-13	1276	1445	723	80	1286	643	1259	O	O	O
DT-110/8S(D)-6	666	1654	830	80	1500	750	649	O	O	O
DT-110/8S(D)-13	1276	1654	830	80	1500	750	1259	O	O	O
DT-203/2S(D)-20	615	177	85	X	X	X	598	O	X	X
DT-203/2S(D)-40	1170	177	85	X	X	X	1153	O	X	X
DT-203/4S(D)-20	615	317	X	72	173	X	598	X	O	O
DT-203/4S(D)-40	1170	317	X	72	173	X	1153	X	O	O
DT-203/6S(D)-20	615	464	X	91	282	X	598	X	O	O
DT-203/8S(D)-20	615	611	X	112	387	X	598	X	O	O

See the draw on the next page

Measures in millimetres. X = Not valid for these models.

P1, P2 and P3: Anchorage point. Used = O. Not used = X. Anchorage holes position on the wall. See valid point (P1, P2 o P3) on the table in the previous page.

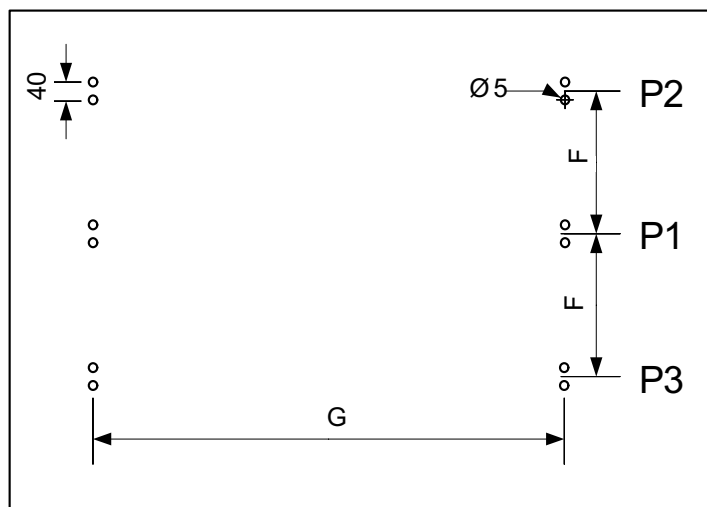
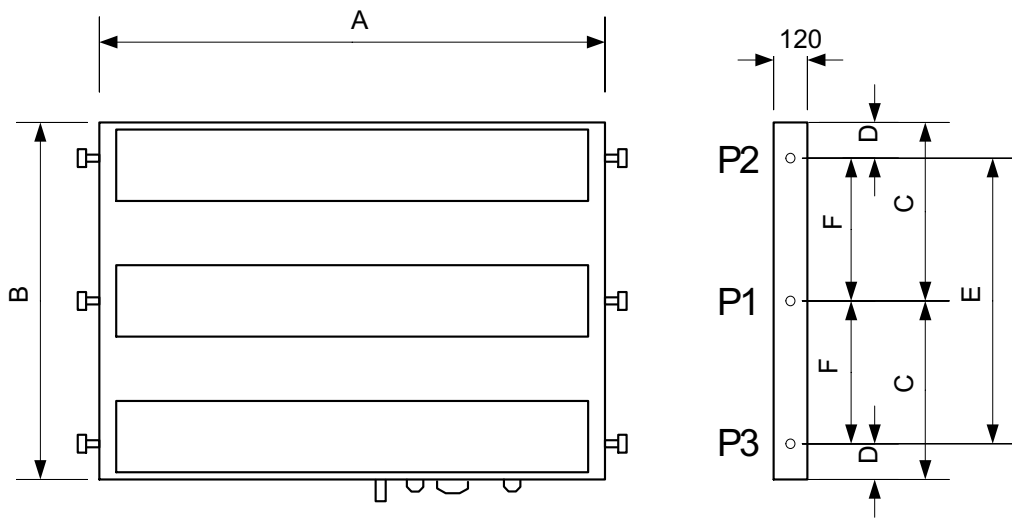

3 INSTALLATION

The installation of the **DT-203**, **DT-105** and **DT-110** is not difficult but some important considerations must be taken into account.

It must not be anchored to places subjected to vibrations, nor should it be installed in places which generally surpass the limits specified in the display characteristics, both in terms of temperature and humidity.

The degree of protection of displays **DN-109**, **DN-119**, **DN-129** and **DN-189** is IP41, it means that are protected against the penetration of strange solid objects greater than 1 mm, and against the vertical rain drops. **DN-129f** is IP54, which mean that is protected against the rain water. The degree of protection of displays **DN-109e**, **DN-119e** and **DN-189e** are IP65, it means that are completely protected against the dust, and water jets.

Displays **DT-203**, **DT-105** and **DT-110**, should not be installed in places with illumination level higher than 1000 lux. Neither should the display be placed in direct sunlight as visibility would be lost. Displays **DT-105h** and **DT-110h** can be read in sunlight.

In the electrical installation, proximity to high-current lines and high voltage lines must be avoided, as well as proximity to High Frequency generators and U/F converters for motors.

3.1 Equipment interfaces

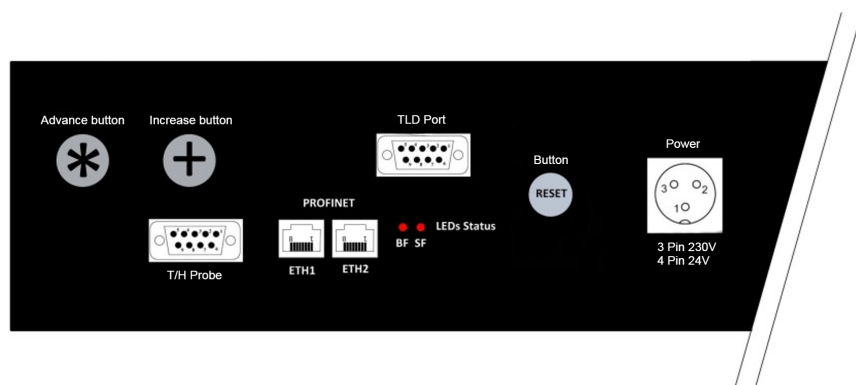

Fig. 2 Connectors and push buttons. Exact positions depend on the model.

3.2 Power supply.

The power supply must be from 100 to 240 VAC, 50/60 Hz or 24VDC (18-36) 24V option.

The external power supply conductor section must be selected according to the consumption and the ground conductor must have a minimum section of 1.5 mm².

The power supply connector for 220VAC has 4 contacts and is placed in the lower part of the unit. Connect the power wires following the schema below

The power supply connector for 24VDC has 5 contacts and is placed in the lower part of the unit. Connect the power wires following the schema below

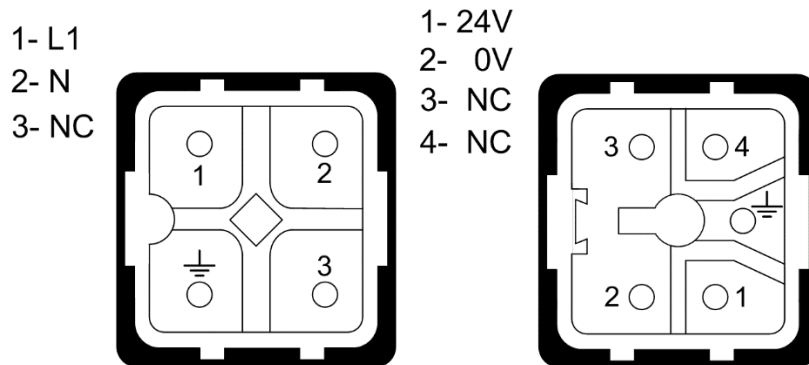

3.3 Wire for the transfer of messages to the display memory.

The operating mode "Message selection by code" (See section 5.2.1) allows to save a set of messages in the device's internal memory (non volatile).

The transfer of messages to the equipment is done by serial line RS-232. Therefore, a Null-modem cable must be available (Fig. 3) in order to connect the computer to the display.

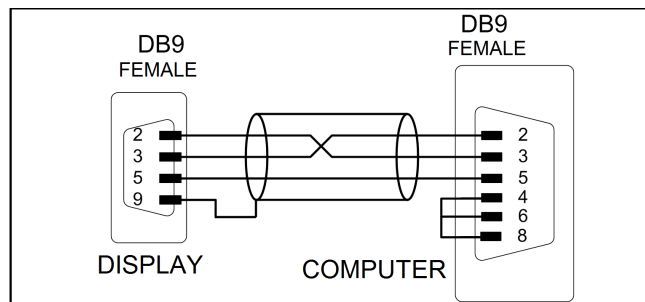

Fig. 3 Connection between the computer and the display (RS232)

The TDLWin application available on our website allows us to edit the text messages, with icons that eases the insertion of commands for special functions such as flashing a section of the message, displaying date, time, temperatura, etc.

This application in addition to transferring the messages to the internal memory of the equipment, also allows saving the message in a file as backup or to transfer to more than one display.

3.4 Characteristics of temperature & humidity probe. (Option)

Relative humidity

Resolution 1%

Accuracy $\pm 4,5\%$ between 20% and 80% (Typical)

Temperature

Resolution 0,1°C

Accuracy $\pm 0,5^\circ\text{C}$ typ $\pm 2,5$ MAX

Range From -20°C to $+60^\circ\text{C}$.

3.5 Wiring of temperature & humidity probe (Option)

The temperature & humidity probe is delivered with 2m cable and a Sub-D9 connector ready to use.

The wiring of connector probe is shown in the diagram (cable connector).

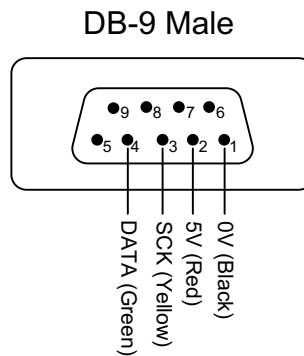

3.6 Reset button

If the display has not been powered for many days, the battery may be discharged. In this case when the power is restored, the battery may be not fully charged, and it may be necessary to force a reset. The display must be connected to the power supply when the reset button is pressed.

3.7 IP65 Profinet connectors installation.

3.7.1 IP65 Profinet connection

The installation of Profinet Bus connector is very simple, it is not necessary to use special tools, but the instruction must be followed carefully.

In the accessories bag find the following:



We start screwing cable gland to the grey case, squeezing it strongly with some tool help as an adjustable spanner.

After, we pass the Ethernet cable (not supplied) through the cable gland and start the IP65 connector mounting. Together with the connector there is a manual explaining in detail its installation.

Once mounted, we connect the cable to the display (to maintain IP65 seal, only one cable is admitted, connected to one of two connectors available) and we proceed to fix the case in to the display. Highest part of the grey case at the left anchorage of the display (blue circle) and the lowest part to the right anchorage (red circle) (see the image below).

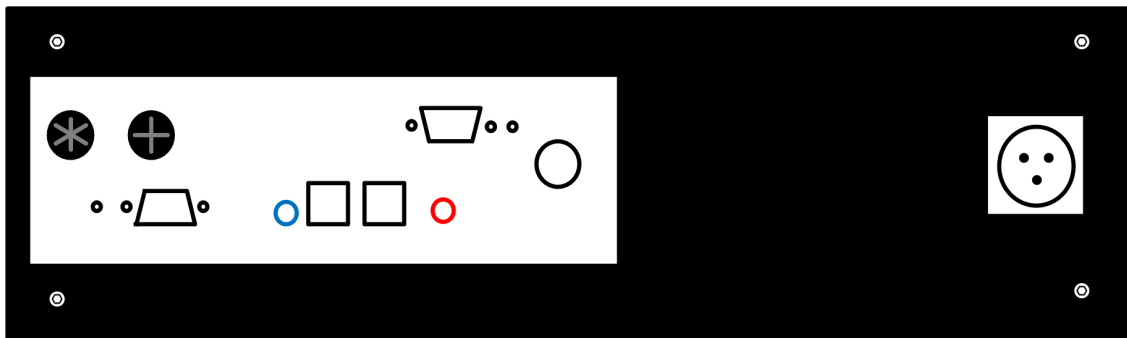

⚠ Improper installation cancels the protection IP65 and the warranty.

Once placed, with the help of a flat screwdriver, turn the locking screws until it is tight enough.

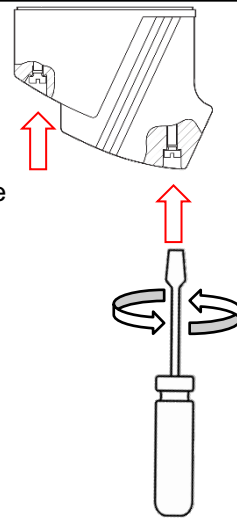
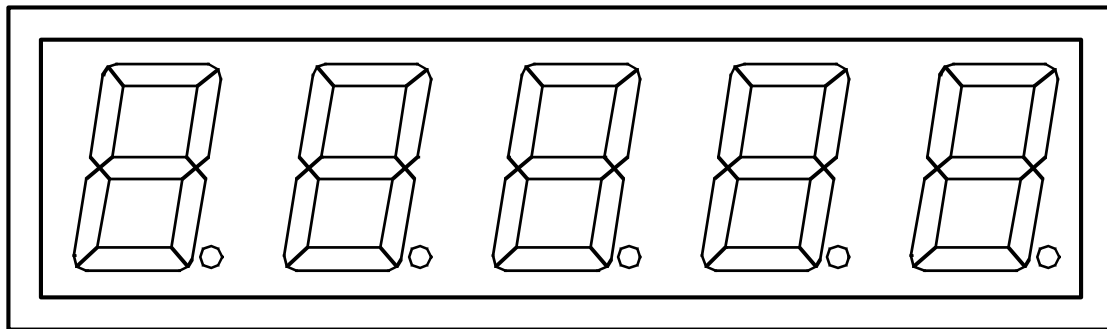

To finish we only have to close the cable glad as strong as possible to avoid that the dust or water can enter.

3.7.2 DB-9 connector with cover (TDL)

The DB-9 mounting is really easy and quick to make, for it, we will pass the cable through the cable glad and leave enough space for its welding (see section 3.3 and/or 3.5) depending if it is for the transfer of messages to the memory or for the temperature and humidity probe.

Once finished, we must put the connector inside the cover, placing correctly the connector holes with the inner screws, then push hard until we notice the “click”.

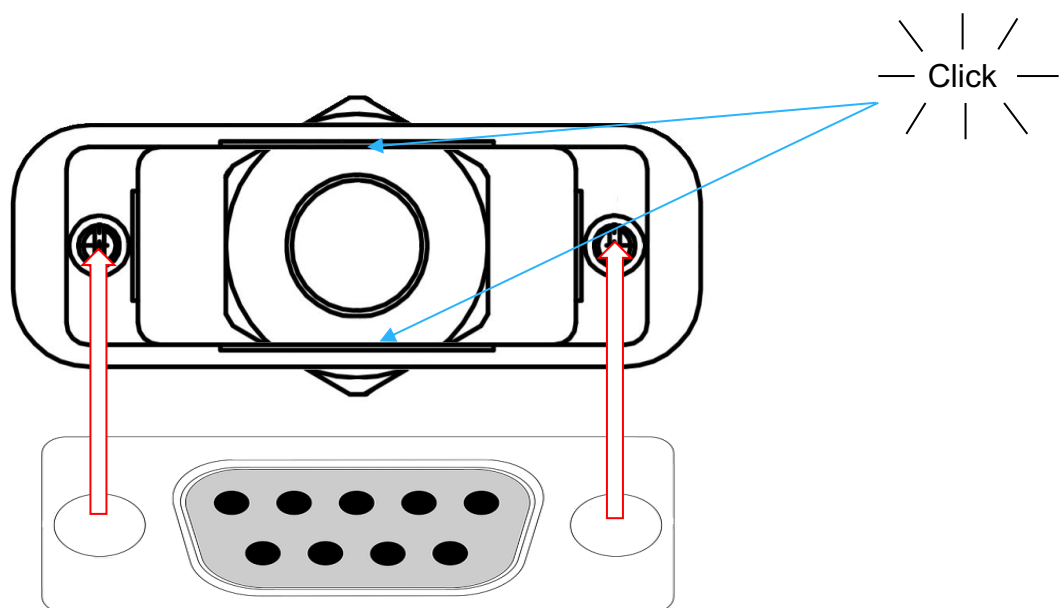

Then we must connect it to the display tightening the screws with a screwdriver for let it well secured, then with the help of a tool we have to tight the cable gland of the connector to acquire finally the protection wished.

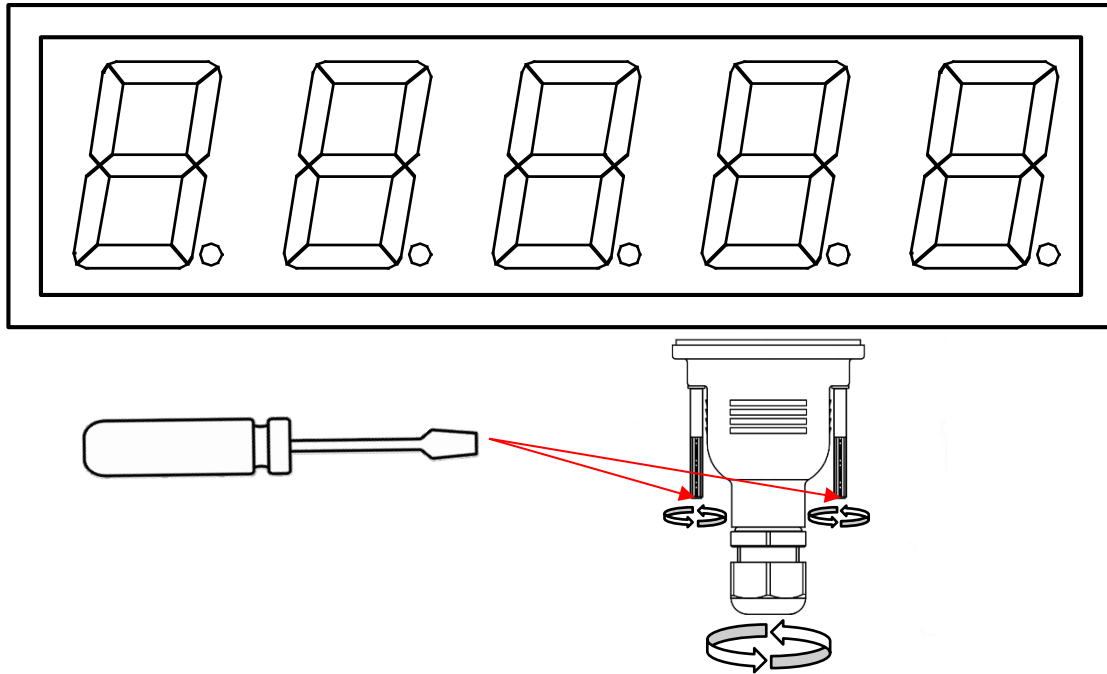

⚠ Improper installation cancels the protection IP65 and the warranty.

4 OPERATION

4.1 Initial Start Up.

The **DT-NN** display is controlled by Profinet communication.

Every time the display is connected to the power supply, three blocks of illuminated LEDs are displayed moving through the display. This allows to visualize the status of the LEDs.

Then, the display reads the message memory and initialises the message table.

During this time (It can take several seconds if there are many messages) the word "INICI" is shown.

When the initialisation process is finished, the display will be ready to receive messages from the network. While the display does not receive the first message, it shows the messages of the internal memory, depending on the selected protocol:

Protocol TDL: Display all memory messages. Presentation mode.

Protocol PROFINET: Display message 0.

4.2 Programming parameters.

Before using the display, the configuration parameters must be set as required.

The parameters configuration is done through a menu that is selected by two buttons placed at the bottom part of the display. The field that can be modified is displayed flashing.

4.2.1 Enter to modify parameters.

In order to enter the sequence to modify the parameters, the Advance key "*" must be pressed and held for three seconds. After this, the first parameter will be displayed, with the parameter name flashing.

There are then two options:

1- Modify the parameter value.

- Press the Advance key "*" and change the selected parameter.
- To return to the parameter name, press again "*" key.
- To surf over the parameter options, press "+" key. When you arrive to the end of the options list, press again "+" key to go back to the first option.

2- Select another parameter.

Press "*" key to flash the "parameter name" (if the "parameter option" is flashing) and use "+" key to select other parameters.

4.2.2 Quit parameter configuration

Select "EXIT" parameter and press "*" to quit.

4.2.3 Parameter description.

4.2.3.1 Parameter: LANGUAGE or LA.

Allows set the language. There are four languages available: **Catalan, Spanish, French and English.**

4.2.3.2 Parameter: Configuration.

Set the operating mode for the messages. There are 2 options:

1. **Code selection:** In this mode, once the messages on the display have been edited and stored, they are activated by sending only the message number.
2. **Direct message control:** By selecting this type of control, the text messages have to be sent as well as control commands that performs special functions, such as flashing a message section, controlling the brightness, inserting the date and time, line feed in the multiline displays, etc.

In sections 5.2.1 and 5.2.2 these operating modes are fully explained.

The internal memory of the equipment comes pre-loaded with factory default messages.
 **If a new list is generated, it must contain at least message 0, which is displayed when the display is powered.**

4.2.3.3 Parameter: Protocol.

The available protocols are: **TDL, PROFINET.**

- **TDL:** Protocol by serial line RS232, which is used in conjunction with the TDLWin program for store messages in the equipment memory and displays them in debug mode.
- **PROFINET:** Industrial standard based on Ethernet, which is configured using engineering tools such as TIA Portal by Siemens, or similar from other PLC manufacturers.

4.2.3.4 Parameter: Date.

Set the display date (can also be configured by Profinet)

4.2.3.5 Parameter: Time

Set the display time. The new time value will be initialized when you quit parameter configuration. The time can also be set by Profinet.

4.2.3.6 Parameter: POS. CONNECTORS or CON

Select the power and Profinet connectors' position. Depending on the installation, it may be more convenient for the connectors to come out at the top or at the bottom of the display. This parameter reverses the text if the display is installed in reverse position.

4.2.3.7 Parameter: DISPLAY SPEED or VDI.

Adjust the horizontal scrolling speed in text messages that have more characters than the display. If you want to show a message of 25 characters in a 20-character display, the message will shift right to left to show all the characters contained in the message and the speed of this scrolling, will be adjustable by this parameter.

4.2.3.8 Parameter: Exit

Press the advance key (“*”) to quit parameter configuration.

5 PROTOCOL AND OPERATIONAL WORK

This section describes PROFINET protocol, as well as the communication with the Displays using this protocol.

The notation of the numerical values which is used in this manual is the following:

- When a **hexadecimal** number is used, the number is followed by “h”
- When a **decimal** number is used, the number is followed by “d”
- When a **binary** number is used, the number is followed by “b”
- When a number is in **ASCII format**, each digit is represented by its ASCII code.

For example: the character X ASCII, can be seen as 58h, 88d or 1011000b. The number 15 ASCII can be described as 31h 35h, 49d 53d or 110001d 110101d according to the context.

Definitions of words used in this chapter description;

Message: Alphanumeric text of one or more lines (depending on the type of display). The message displayed on each line can be static or dynamic. A static message is one whose number of characters is less or equal than the number of characters that can be displayed in a line. The dynamic message will have more characters than characters per line has the display, and therefore the message will be displayed moving from right to left.

Message code: Is the number that identifies the message. The range will be: 0 to 512.

Communication lines: Is the physical connection between the equipments. There are two possible communication types: RS-232 (TDL) and Profinet.

The types of communication available in the DT-105/110/203NN displays are:

1. TDL: Developed for this family of display.
2. PROFINET: Network Standard for industrial automation.

Offline: Operations that must be done on the equipment by means of Display settings or software tools, previous to the installation or operation of the equipment in the network.

Online: Configuration change that can be done with the equipment operating in the network.

XXX o xxx: The ‘X’ sequences are used to indicate characters that can be variable, as versions or dates.

< >: These signs indicate an option that the user has to particularize according the acquired equipment.

5.1 PROFINET protocol.

In this section we will describe the configuration and commissioning of the Profinet Display using the engineering tool TIA Portal V13 by Siemens. In the case of using another engineering tool you must consult the corresponding tool documentation.

5.1.1 Before configuring.

As each PROFINET device is based on DNS (Domain Name System) and the conventions for the denomination of equipment connected to network, it is necessary to assign an identification name to the Display (Device Name). Device Name is assigned to the device through a PROFINET tool, like TIA Portal or others.

In our Displays we use a tool called SW67602¹ which can be downloaded freely from our website and it allows editing the Device Name and other Ethernet network parameters like IP address, network masks, etc.

When done, you must generate the new GSD file and update the display with the new configuration.

Let's see cases where the use of this tool may or may not be necessary:

1. In the Profinet network there is only a DT-NN family display.

The display is always configured at factory with a default Device Name, according to the equipment model.

For example: If we have a **DT-203 of 2 lines and 20 characters** (our reference DT-203/2S-20) the **Device Name** assigned is **dt203-2I-20**. <model>-<number of lines>-<number of characters>.

In installations with only one Display of the **DT-NN** family, it is recommended to use the factory configuration, downloading the GSD with the default configuration from our website and configure TIA Portal as it is described at the section 5.1.4

2. The Profinet network has more than one DT-NN family Display.

In the case you want to install more than one alphanumeric display on the same Profinet network, it is mandatory to change device name since each one must have a different name. Please use the tool provided.

The procedure for using the configuration application SW67602 is described in the section 5.1.3.

¹ It runs in Operating System MS Windows (XP,Vista,7,8,10)

5.1.2 Download GSD file.

On our website, on the download page you can find the file **GSDML_DTNN_V2.31.zip**, with all the configuration files for the DT-NN family.

Once unzipped, there will be a set of .xml files. You should consult the display item code (label located in the connectors' area) to select the right file. From this label; the model information, number of lines and characters can be obtained.

Our item codes have the following format:

- Single-sided models:
<Model>/<number of lines>**S**-<number of characters>
- Double-sided models:
<Model>/<number of lines>**D**-<number of characters>

For example, our item code DT-105/1S-6, corresponds to the model **DT-105** with **1 line** and **6 characters**. The same GSD is used for single-sided (S) or double-sided (D) models. You will select your GSD file according to model, number of lines and number of characters.

GSDML-V2.25-XXXxxx-XXXXXXX-<Model>_<number of lines>L_<number of characters>C-XXXXXXXX.xml

For the previous item code example, the GSD to use would be:

GSDML-V2.25-XXXxxx-XXXXXXX-DT105_1L_6C-XXXXXXXX.xml

5.1.3 Creating a GSD custom file.

In the case that you need avoid the duplicity of devices with the same Device Name, you must use the SW67602 software to change the Profinet parameters, create the new GSD and update the Display Firmware.

Find and download the GSD file **FW_Lartet_DT-NN.zip** at our website, containing the configuration project for the DT-NN display family.

Once unzipped, you will get a set of folders, with the model name, number of lines and number of characters.

As described in the previous section, from the item code you can get the model, number of lines and characters of the display.

For example, to work with a DT-105/1S-6 the folder DT105_1L_6C must be selected which contains the configuration files.

Once installed the software SW67602, you will find the folder "Projects" in the installation directory of this program. The folder that we have selected with the configuration files, must be moved inside "Projects" folder.

Once this action is done, we will execute the application and the options window will be showed. We select **“Open Configuration”**, to open the configuration project. It is the configuration “DT105_1L_6C” in our example.

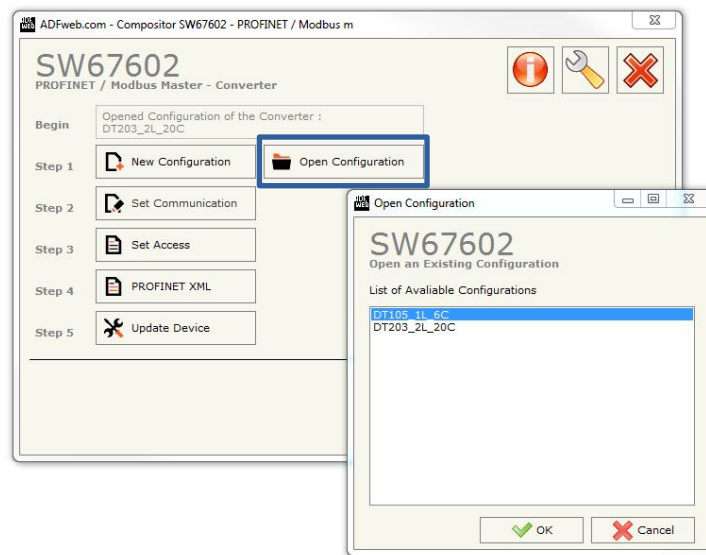

Fig. 4 Open the project configuration

Choose the configuration Project and press OK. Select the option **“Set Communication”** and edit the communication parameters

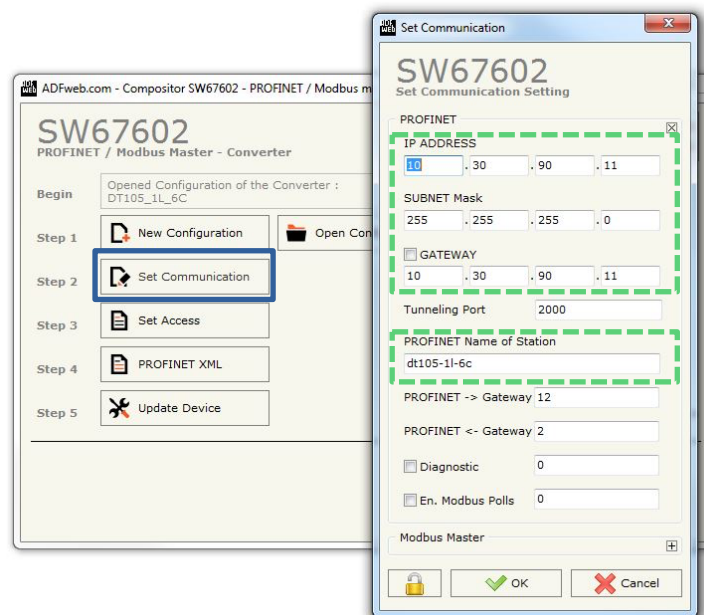

Fig. 5 Set communication parameters.

⚠ Edit only the data fields delimited by the dashed line, value changes in any other fields can result in display malfunction.

With the communication parameters updated to the installation requirements, press 'OK' to accept the new values and choose the "**PROFINET XML**" option to create the new GSD.

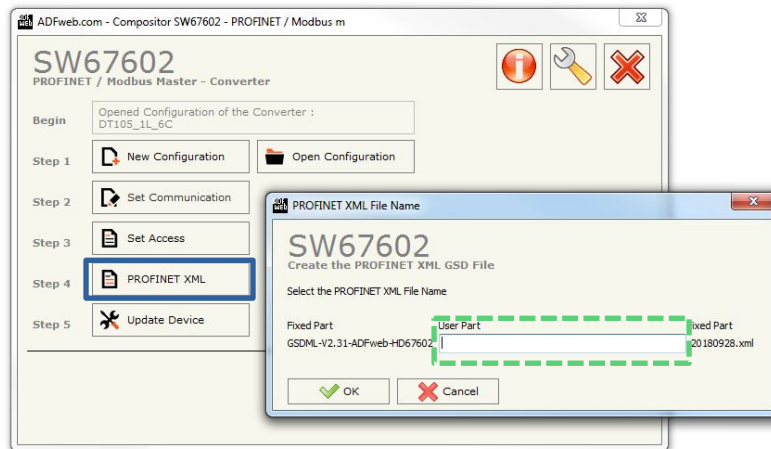

Fig. 6 Creating the updated GSD

Name your customized GSD and write it in the data field, accept and this will generate the updated GSD. The new GSD will be created inside the folder "DT105_1L_6C".

As last step, we must update the display firmware with the new parameters, selecting "**Update Device**".

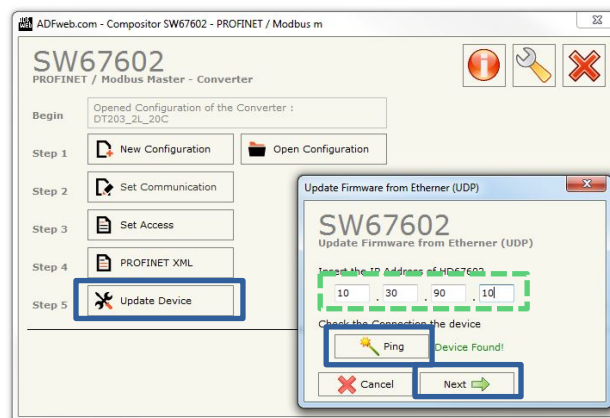

Fig. 7 Update FW display

The factory IP address is 10.30.90.11. We must insert this address in the data field to update the device. The "**Ping**" button detects the device before starting the update. If the device is found, the message "**Device Found!**" will appear, press the button "**Next**" and "**Execute Update Firmware**" to continue with the update process. Once finished the process the display will be ready to install with the TIA Portal utility or similar.

If the device is not found, the message “**Error!!! Check the IP Address**” will be showed. This can happen with equipment already installed that works with a dynamically IP assigned by the PLC, or with offline equipment, which for some reason the IP address has been changed from default value. If the equipment IP address is unknown, there are some utilities that find automatically Profinet equipment connected to the network and show their main parameters. We suggest using the application “Proneta” by Siemens, which is free to download.

This program will perform a network scan and will display the Profinet devices connected.

Accessible Devices - online										
#	Name	DNS Name	Device Type	IP Address	Device ID	MAC Address	Role	Gateway	Vendor ID	Vendor Name
1	cristinag	cristinag	SIMATIC-PC	10.30.90.26	0x0202	fc3fabbb2a94d	Unspecified	10.30.90.200	0x002A	SIEMENS AG
2	dn1x9	dn1x9	HD67602	10.30.90.14	0x0078	10:64:e2:07:be:59	Device	10.30.90.14	0x1111	Unknown (4368)
3	dt203-2l-20c	dt203-2l-20c	HD67602	10.30.90.12	0x0078	10:64:e2:07:be:67	Device	10.30.90.12	0x1111	Unknown (4368)
4	plc_1	plc0b1d0ed	S7-1500	10.30.90.16	0x010E	00:1b:1b:13:38:67	Controller	10.30.90.16	0x002A	SIEMENS AG

Fig. 8 Profinet Displays

5.1.4 Display installation in TIA Portal V13

This section shows the steps for the display integration in the Profinet network.

1. Install the displays GSD/s

In TIA Portal V13, press the button “**Options**” and select “**Install general station description file (GSD)**” (The field “**Source path**” must contain the directory where the GSDs has been saved to list the content).

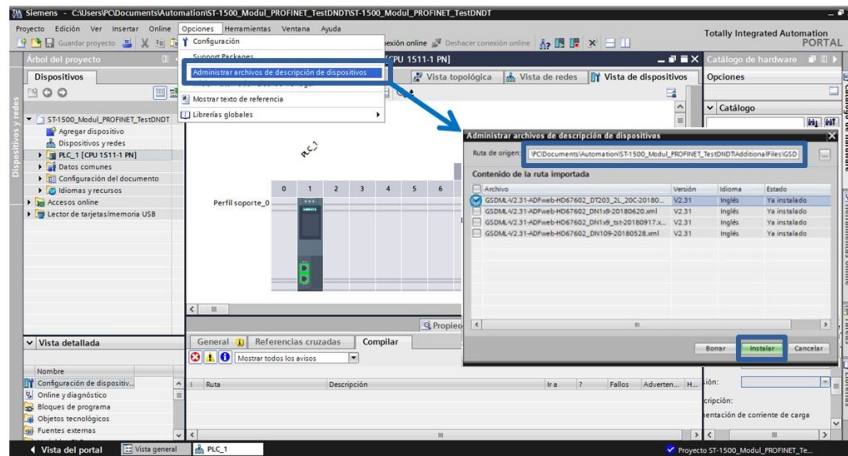

Fig. 9 Install the description file of the device (GSD)

Choose the GSD files for the displays which will be included in the Project and press the button “**Install**”. Wait until the installation process ends and the devices will be ready to be configured as follows.

2. Add the displays to the Project.

Press the button “**Devices and networks**” (1), from the right drop-down menu “**Hardware Catalog**”, inside “**Other field devices**” (2), look for HD67602 and select the module “**serial**” and at the “**Version**” field (3) choose the GSD that you want to include in the project. Drag the serial module to the “**Network view**”

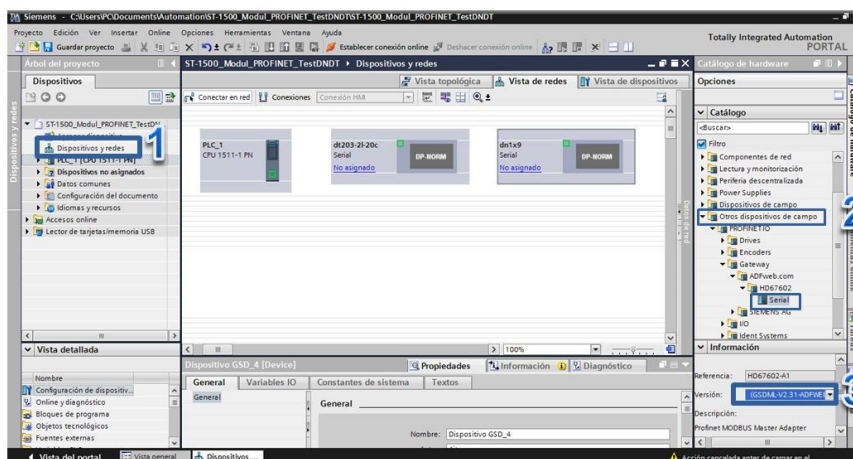

Fig. 10 Add displays to the project.

3. Add displays and PLC to the Profinet Network

Connect the displays to the PLC by drawing the Ethernet wire joining the display ports with the PLC Port.

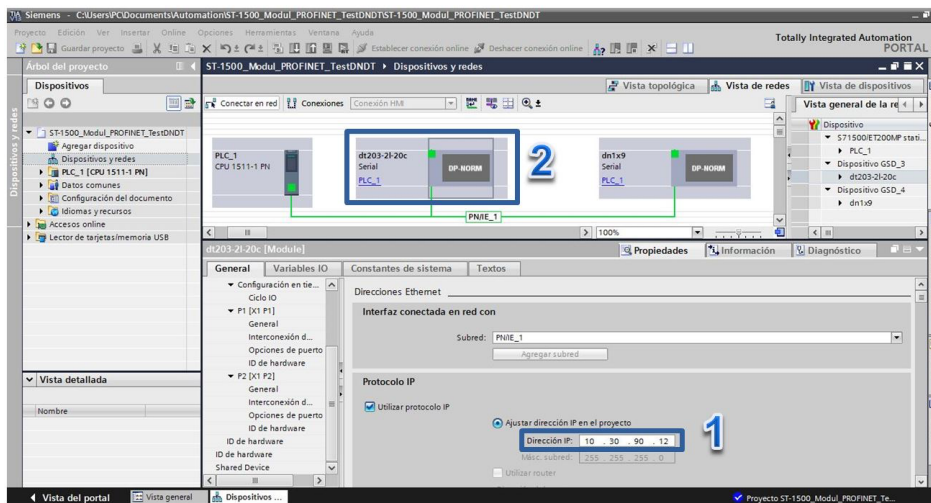

Fig. 11 Define the Displays connection with PLC

Select each one of the displays modules included and assign its IP address (1) in the Profinet network. The “**Device view**” will be displayed *double clicking* in a particular display.

4. Assign the E/S address space.

In the “**Device view**” field, check that the “**Name**” (1) matches with the “Device Name” assigned to the device (TIA Portal add the suffix **_1**, **2...** to avoid duplicity). If the name is different to the one programmed into the Display, rename it to match with the programmed.

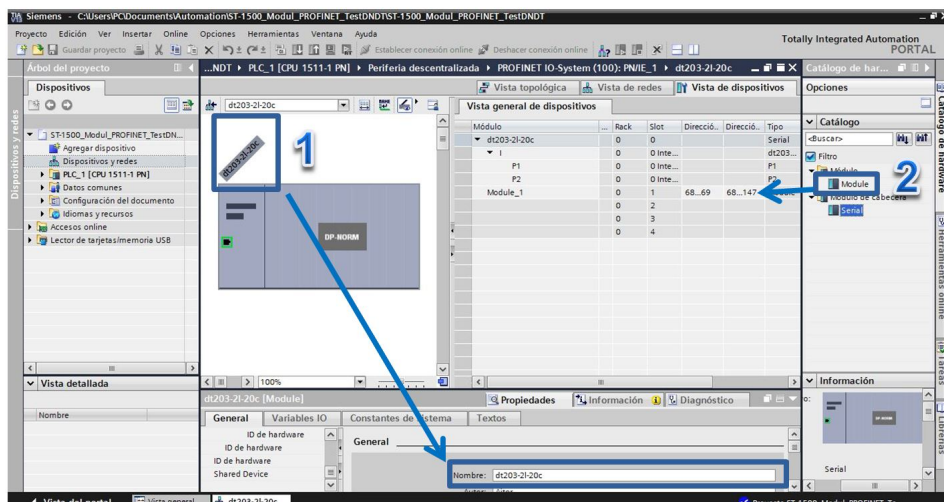

Fig. 12 Assign the E/S addresses of the devices.

To define the input/output address range in the PLC, drag “Module” to the address fields of slot 1 in the device and fix the start addresses corresponding to input and output according your available addresses.

Depending on the display model the output address range will be sized accordingly to the number of lines and characters. With regard to the input addresses, only 2 bytes will be used for return control information in future updates of the product (actually no data is returned).

5. Compile and update the project in the PLC

With all the elements added and configured, compile the project (1). Once verified that there are no compilation errors, load the configuration into the PLC (2).

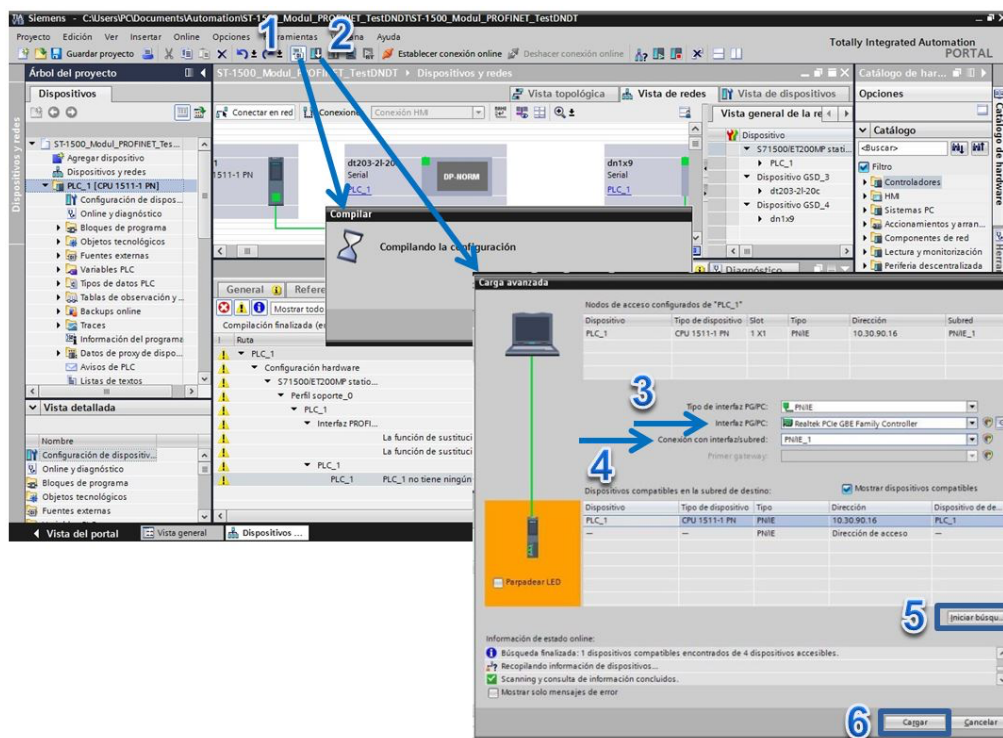

Fig. 13 Compilation and configuration upload in the PLC

To download the configuration to the device, select the network card in the “**PG/PC interface**” field (3) at “**Extended download to device**” window, and establish the identifier of the Profinet network (PN/IE_1 in this example, See Fig. 11) in the “**Connection to subnet**” field (4).

Press “**Refresh**” (5), to detect the PLC and “**Load**” (6) to start the PLC programming.

5.2 Operational modes

As mentioned, previously, this display has two working modes “Selection by code” and “Control by direct message”. Let’s detail how it is configured and operated in each operating mode.

5.2.1 Code selecting

In this mode we will work sending a data frame through the Profinet network that will contain a certain message code stored in the internal memory that select and display the message. To work in this mode, we will follow the next steps:

1. Configuration of the display parameters.

Enter to parameter configuration using the display keys (section 4.2.1) and adjust the following parameters:

CONFIG: 001



PROTOCOL: TDL (Used only to storing messages in the equipment)

2. Upload of the messages to the internal memory of the equipment

To load the message to the display, it is necessary to use a computer with **WindowsXP/7/8/10** operating system and the “TDLWin” program specifically designed for the programming of these displays. TDLWin program is available at our website for free.

All the displays have pre-programmed default factory messages. If you change them, please remember that at least one message must be defined (message 0), which is displayed by default after the equipment power on.

To program the messages the following actions must be done:

- **Connection:** Connect a Null-modem cable between the computer and the display as it is described at section 3.3.
- **Display:** Select the “Configuration” parameter in the display “See section 4.2.3.2) and configure the “TDL” protocol.
- **Application TDLWin:**
 1. Go to the “Configure” option.
 2. In the “Display” window, select the “family” and “model” of the equipment to be programmed. This will determine the number of lines available by each message code.
 3. In the “Serial line”, select the port where the Null-modem cable is connected, and configure the following parameters:
 - **Speed:** 9600
 - **Data Bits:** 8
 - **Parity:** Par
 - **Stop Bits:** 2
 4. Edit messages (There are icons that allow quick insertion of special commands for message blinking , date or time information  or temperature and humidity measures  in displays with this option).

5. To transfer the messages to the display, press the icon  "Send messages to the *Display*" and if everything is OK, we will see the message "programming" on the display.

If this message does not appear, check that the COM port number on the computer is correct, the state of the Null-modem cable and that the communication parameters are as indicated above.

 **Depending on the number of messages, the message recording can take few minutes to complete.**

3. Selection of messages by Profinet network.

Prior to sending data through the Profinet network, we must change the display protocol parameter to:

PROTOCOL: PROFINET

The data block to select the message consists of 4 bytes.

%QBx	%QBx+1	%QBx+2	%QBx+3
B1	B2	B3	B4

Being %QBx, the first output address of PLC which we have configured the display module and %QBx+1,...,%QBx+3 the address of the successive bytes.

B1,...,B4 Are the data bytes contained in these addresses, where:

B1: Most significant byte for the message number.

B2: Least significant byte for the message number

B3: Always 00h

B4: Always 00h

Example: If we have a DT-203/2S-20 (2 lines and 20 characters display) and have edited, through TDLWin, the following message list:

Message	Line	MessageText
0000	1	Message 1 L1
0000	2	Message 1 L2
0001	1	Message 2 L1
0001	2	Message 2 L2
0002	1	Message 3 L1
0002	2	Message 3 L2
0003	1	Message 4 L1
0003	2	Message 4 L2
0004	1	Message 5 L1
0004	2	Message 5 L2

Assuming that the same range of output addresses have been configured as shown in Fig.12, which goes from %QB68..%QB147, the data frame to be sent is the following:

Show message number 0001:

%QB68	%QB69	%QB70	%QB71
00h	01h	00h	00h

Text displayed: **Message 2 L1**
 Message 2 L2

Show message number 0004:

%QB68	%QB69	%QB70	%QB71
00h	04h	00h	00h

Text displayed: **Message 5 L1**
 Message 5 L2

 If you want to leave a blank line in a multiline display, you must write the space character in that line, because if a line does not write any character, the previous message is maintained.

5.2.2 Control by direct message

In this mode the whole message will be sent by Profinet network, including the special commands: line break, flashing, brightness control, etc.

To work in this mode, follow the next steps:

1. Display parameters configuration

Enter to parameter configuration using the display keys and adjust the following parameters:

CONFIG: 002

PROTOCOL: PROFINET

2. Send the character string through the Profinet network.

The length of the data will be as long as characters have the message and lines you want to visualize. The data block is sent as a string of characters, starting at the first available output address of the PLC that corresponds to the first character on the first display line. If the number of characters sent is greater than the number of characters on the display, the message will be showed in the Dynamic representation mode, scrolling right to left to show the whole message. (See section 4.2.3.7 to adjust the scrolling speed).

Using the special commands, like “line feed” we can redirect sections of the message to other lines (in multiline displays)

Depending on the number of lines and characters of the display, a larger or smaller buffer size will be reserved. Generally, for displays up to 3 lines, the length of the buffer is dimensioned following the rule: **(number of characters x 2) x number of rows**. To avoid reserving an excessive range of addresses in the PLC, this rule can vary in displays of more than 3 rows and 20 characters. To determine exactly the buffer size assigned in a display, we get the range of

output addresses in TIA Portal and apply the expression $(\%Q_{end}-\%Q_{begin})+1$ to determine the length in bytes.

The user must manage the output buffer conveniently, for example, if you have a DT-203/2S-20 (2 lines and 20 characters display) with an output buffer of 80 bytes, and writes a message of 70 characters + 3 special commands in the first line, only 7 characters could be written in the next line. The maximum length allowed by line are 160 characters.

In section 5.2.3 we sum up the special characters allowed and its function.

Let's see some examples in a DT-203/2S-20 display.

We will use the type ***italic-bold font*** as notation for special characters.

b>

Example 1:

We want to visualize the message “¿Que hora es?” in the first line and “Son las HH:MM:SS” (Using the time special character) in the second line.

Assuming the range of output addresses assigned in Fig. 12, we will send the following sequence:

Addr	%QB68	%QB69	%QB70	%QB71	%QB72	%QB73	%QB74	%QB75	%QB76	%QB77	%QB78	%QB79	%QB80	%QB81
ASCII	¿	Q	u	e		h	o	r	a		e	s	?	♀
HEX	A8h	51h	75h	65h	20h	68h	6Fh	72h	61h	20h	65h	73h	3Fh	0Ch
Addr	%QB82	%QB83	%QB84	%QB85	%QB86	%QB87	%QB88	%QB89	%QB90	%QB91				
ASCII	S	o	n		l	a	s		↑	♪				
HEX	53h	6Fh	6Eh	20h	6Ch	61h	73h		18h	0Dh				

Displayed Text: **¿Qué hora es?**
Son las 14:51:03

The characters 0Ch, 18h and 0Dh are the special commands for line feed, time insertion (HH:MM:SS format) and end of data respectively.

Example 2:

In the same display model, we want to display the following message: “T3 Detenido” in the first line, with the word “Detenido” flashing and the message “Fallo LD5” in the second line. Also, you want to visualize these messages selecting minimum light level.

Addr	%QB68	%QB69	%QB70	%QB71	%QB72	%QB73	%QB74	%QB75	%QB76	%QB77	%QB78	%QB79	%QB80	%QB81
ASCII	T	3		■	D	e	t	e	n	i	d	o	○	♀
HEX	54h	33h	20h	08h	44h	65h	74h	65h	6Eh	69h	64h	6Fh	09h	0Ch
Addr	%QB82	%QB83	%QB84	%QB85	%QB86	%QB87	%QB88	%QB89	%QB90	%QB91	%QB92	%QB93		
ASCII	F	a	l	l	o		L	D	5	“	1	♀		
Addr	46h	61h	6Ch	6Ch	6Fh	20h	4Ch	44h	35h	22h	31h	0Dh		

The new special commands involved are: 08h (start flashing), 09h (end flashing) and 22h (light level needs a parameter ranging from 1 to 8 to set the level)

The following section details the ***special commands***.

5.2.3 Special commands

0Ah A **line feed** will be forced in the multiline displays. If the new message is shorter than the previous one, the characters not overwritten will not be deleted.

0Ch A **line feed** will be forced in the multiline displays. Using this command, the previous message is deleted (no matter message length).

Example: Current text: "ABCDEFGHJIJ"

Message sent: "123456"+ **0Ah** Displayed text: "123456GHIJ"

Message sent: "123456"+ **0Ch** Displayed text: "123456"

0Dh **End of data**. At the point that this command is inserted, the display will ignore the characters and special commands that follows this command.

08h **Start of digits blinking.**

09h **End of digits blinking.**

15h **Display date**. Format DD/MM/YY.

16h **Display time**. Format HH:MM

18h **Display time**. Format HH:MM:SS

1Ch **Set date and hour**.

Example: Set the date and time to: 29/06/18 15:30

Addr	%QB68	%QB69	%QB70	%QB71	%QB72	%QB73	%QB74	%QB75	%QB76	%QB77	%QB78	%QB79	%QB80
ASCII	L	2	9	0	6	1	8		1	5	3	2	
HEX	1Ch	32h	39h	30h	36h	31h	38h	20h	31h	35h	33h	32h	

This command performs the internal setting, the date/time display command can be used to show the setting.

22h Set **the display light level**. It needs a subparameter ranging from 01h (min.) to 08h (max.) to set the level.

Example: 22h 34h (Adjust the brightness to the medium level).

B6h Arrow up.

B7h Arrow down

B8h Short arrow to the right.

B9h Short arrow to the left.

BCh + **BAh** Long arrow to the right.

BBh + **BDh** Long arrow to the left.

ONLY WITH TEMPERATURE AND HUMIDITY OPTION.

1Eh **Temperature display** in Celsius.

1Fh **Temperature display** in Fahrenheit.

21h **Display the relative humidity.**

5.2.4 Status LEDs

For troubleshooting in Profinet communication, the equipment has status LEDs that indicate problems with duplicate IPs, repeated Device Names, or problems in the ARs between controller and network devices.

The following table describes the meaning of the LEDs

LED	SIGNIFICADO
BF (Failure bus) ●	ON: The Ethernet connection is defective; IP address is duplicated in the network; DeviceName is duplicated in the network; The IP is not defined. Flashing: At least one configured AR is no longer in the data exchange. OFF: No errors are present.
SF (Group error) ●	ON: At least one AR is not in the data exchange. OFF: No errors are present.