

POWER NETWORK ANALYSER
N100



USER MANUAL



Contents

1 APPLICATION.....	5
2 METER SET	6
3 BASIC REQUIREMENTS, OPERATIONAL SAFETY	6
4 INSTALLATION.....	7
5 METER DESCRIPTION	8
5.1 Current inputs.....	8
5.2 Voltage inputs	8
5.3 External connection diagrams	8
6 N100 PROGRAMMING.....	13
6.1 Front panel.....	13
6.2 Power-on message.....	15
6.3 Operating modes	16
6.4 MEASURING mode	19
6.4.1 Measurement of voltage and current harmonics	20
6.5 Parameter settings	25
6.5.1 Setting of meter parameters PAr.....	27
6.5.2 Setting the input and output parameters InoUt.....	30
6.5.3 Alarm configuration ALn.....	31
6.5.4 Analog outputs configuration Ao_n	35
6.5.5 Pages configuration PAG	39
6.5.6 Archiving configuration Arch	42
6.5.7 Ethernet settings configuration Ethr	45

7 MEASURING VALUES ARCHIVING	48
7.1 INTERNAL MEMORY.....	48
7.2 COPYING ARCHIVE TO SD CARD.....	48
7.3 ARCHIVE FILES STRUCTURE	49
7.4 DOWNLOADING ARCHIVE FROM SD CARD	50
8 SERIAL INTERFACES.....	51
8.1 RS485 INTERFACE – list of parameters	51
8.2 Examples of registers' readout and write	51
8.3 Ethernet interface 10/100-BASE-T	56
8.3.1 Connecting 10/100-BASE-T interface	56
8.3.2 WWW Server	58
8.3.3 FTP Server.....	61
8.3.4 Modbus TCP/IP	63
8.4 Map of N100 meter registers	63
9 SOFTWARE UPGRADE	91
10 ERROR CODES.....	93
11 TECHNICAL DATA.....	94
12 ORDERING CODE.....	100

1. APPLICATION

The N100 meter is a programmable digital instrument designed for the measurement of 3-phase, 3 and 4-wire power network parameters in balanced or unbalanced systems. The measured values are displayed on a two-color LED display. The meter enables control and optimization of the power electronic devices, systems and industrial installations.

The meter provides measurement of: RMS of voltage and current, active, reactive and apparent power, active, reactive and apparent energy, power factors, frequency, the harmonics of current and voltage /up to 51st/, THD of voltage and current, averaged active and apparent power P Demand, S Demand, averaged current I Demand /15, 30 or 60 minutes/. Voltages and currents are multiplied by given voltage and current ratios of the measuring transformers. Power and energy indications take into account all programmed ratio values. The value of each measured value can be transmitted to the master system via the RS-485 or Ethernet interface. Three relay outputs signal the overflow of the chosen value, and the pulse output can be used for the consumption check of 3-phase active energy. The programmable analog outputs map the assigned parameter. The pulse input can be used to check the counters with the pulse outputs.

There is a galvanic separation between following units of the meter:

- supply
- voltage inputs
- current inputs
- RS485 interface
- Ethernet interface
- pulse input
- pulse output OC
- alarm outputs
- analog outputs

2. METER SET

Complete set of the meter includes:

- | | |
|-----------------------------------|-------|
| – N100 Meter | 1 pc |
| – user's manual | 1 pc |
| – warranty card | 1 pc |
| – screw clamp to fix in the panel | 4 pcs |
| – RS485 interface connector | 1 pc |

3. BASIC REQUIREMENTS, OPERATIONAL SAFETY

In terms of operational safety the controller meets the requirements of the EN 61010-1 standard.

Comments concerning safety:

- The meter should be installed and connected only by a qualified personnel. All relevant safety measures should be observed during installation.
- Always check the connections before turning the meter on.
- Prior to taking the meter housing off, always turn the supply off and disconnect the measuring circuits.
- Removal of the meter housing during the warranty period voids the warranty.
- This meter conforms to all requirements of the electromagnetic compatibility in the industrial environment.
- A switch or a circuit-breaker should be installed in the building or facility. It should be located near the device, easily accessible by the operator, and suitably marked.

4. INSTALLATION

The meter is adapted to be fixed to the panel with mounting brackets as presented on Fig. 1. The meter housing is made of a self-extinguishing plastics.

Housing overall dimensions 144 x 144 x 77 mm, dimensions of the assembly hole 138 x 138 mm. There are screw terminal strips on the outer side of the meter which enable the connection of external wires of diameter up to 2.5 mm².

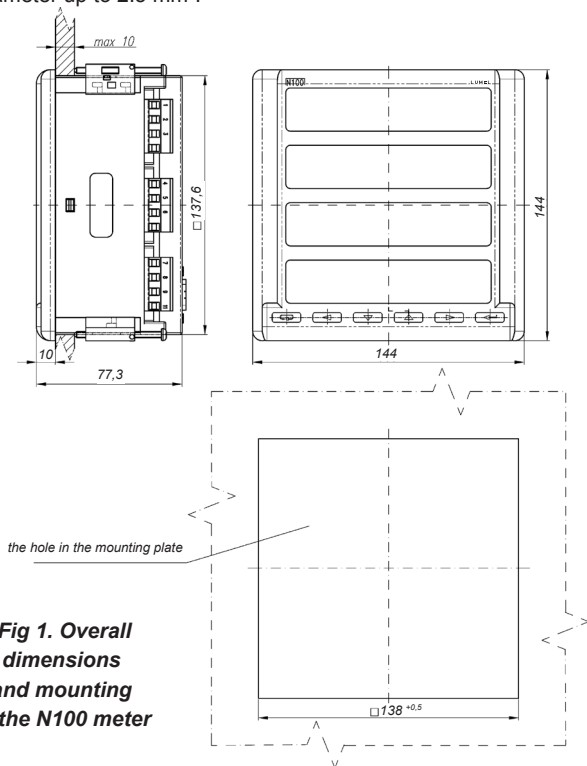

Fig 1. Overall dimensions and mounting of the N100 meter

5. METER DESCRIPTION

5.1 Current inputs

All current inputs are galvanically isolated (internal current transformers). The meter is adapted to work with external measuring current transformers / 1 A or 5 A /. Displayed current values and derivative values are automatically converted in relation to the introduced external current transformer ratio.

5.2 Voltage inputs

All voltage inputs are galvanically isolated (internal transformers). Values on voltage inputs are automatically converted according to the introduced ratio of the external voltage transformer. Voltage inputs are specified in the order as 3x57.7/100V, 3x230/400V or 3x400/690V.

5.3 External connection diagrams

External connections are shown in Figures 2 and 3.

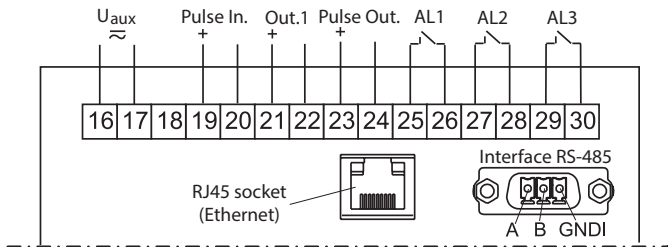

Version: 3 relays, 1 analog output, 1 pulse input, 1 pulse output

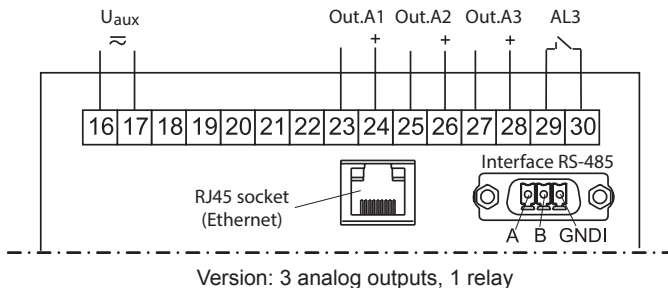
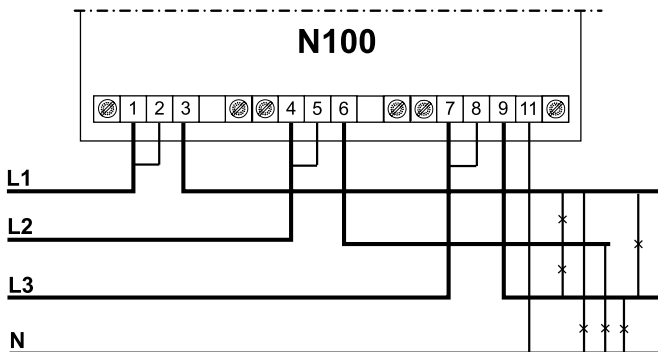

Fig. 2. Connections of output signals



Direct measurement in 4-wire network

Indirect measurement using 2 current transformers and 2 or 3 voltage transformers in a 3-wire network

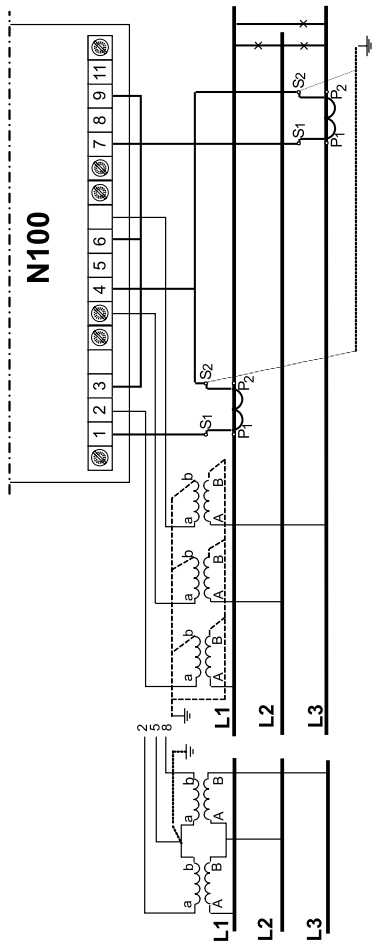

Fig. 4. Meter connections of input signals in a 3-phase 3-wire network

6. N100 PROGRAMMING

6.1 Front panel

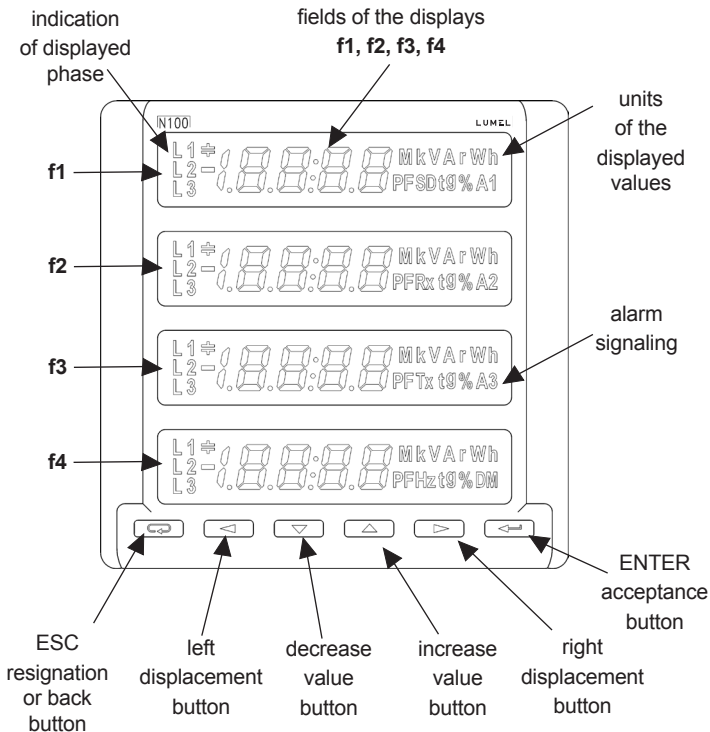









Fig.5. Front panel

The N100 meter has 6 buttons, 4 4½-digit display sections, illuminated symbols and unit parameters. The values of the measured parameters are shown on the active pages selected by subsequent pressing the button  (next page) or  (previous page).



The page consists any 4 values selected from the Table 1 and displayed simultaneously on the meter. The page definition is described in the configuration mode P.



Front panel description:

	ENTER acceptance button	f1,f2,f3,f4	4 4 ½ -digit display sections for readout and settings
	right displacement button	Var Wh PF tg	units of the displayed values
	increase value button	L1 L2 L3	indication of displayed phase
	decrease value button	A1A2A3	symbols of alarms activation
	left displacement button	DM	Averaged value indicator (Demand)
	ESC resignation or back button	k, M	kilo = 10 ³ , Mega = 10 ⁶
		RxTx	Indicators of receiving and transmitting data on the RS485 link
		SD	indicator of writing on SD/SDHC card

The assignment of individual buttons is as follows:

The button  allows to enter the procedure SET (pressed for more than 3 seconds) when programming is used to accept the entered value.

The buttons   when programming are used to change the value of the digit in the decimal position. They enable to display the minimum and maximum values respectively in the measurement mode.

The buttons   enable to change the pages in the measurement mode, when programming enable a cursor displacement to successive decimal positions, in the procedure SET enable to change the displays luminosity.

The button  enables in anytime the resignation of carried out operations or return to a higher level in the procedure SET. It cancels the alarms in measurement mode.

6.2 Power-on message

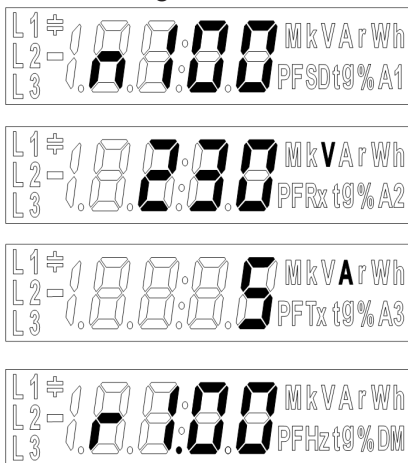



Fig. 6. Message after starting the meter



After switching the supply on, the meter performs a display test and displays the N100 meter name, version and current software version where:

N100 – meter type,
 230V 5A – version
 r1.00 – revision, version of the program



6.3 Operating modes

The N100 meter has 8 modes listed below:

Mode		Call out	
Name	Call out symbol	Input	Output
measurement		default	by entering a different mode
meter parameters	<i>PRr</i>	in SETUP procedure	 , or  after last parameter
inputs and outputs parameters binary and RS485 interface	<i>inOut</i>		
alarm configuration	<i>AL 1</i> <i>AL 2</i> <i>AL 3</i>		
analog outputs configuration	<i>AO 1</i> <i>AO 2</i> <i>AO 3</i>		
pages configuration	<i>PRD</i>		

Archive parameters	<i>Arch</i>	in SETUP procedure	 , or  after last parameter
Ethernet parameters	<i>Ethr</i>		

The meter enters the measurement mode and displays the page set before it was turned off after switching the supply on and performing the tests. To enter the SETUP procedure, press the button  for approx. 3 seconds.

Use the buttons   to select an appropriate mode. Active mode *PAr*, *InOut*, *ALn*, *ALn*, *PAL*, *Arch* or *Ethr* is indicated by blinking of the appropriate symbol. Accept a selected mode by pressing the button .

where: n – number of an alarm or analog output

Use the button to return to a measurement mode from other modes .

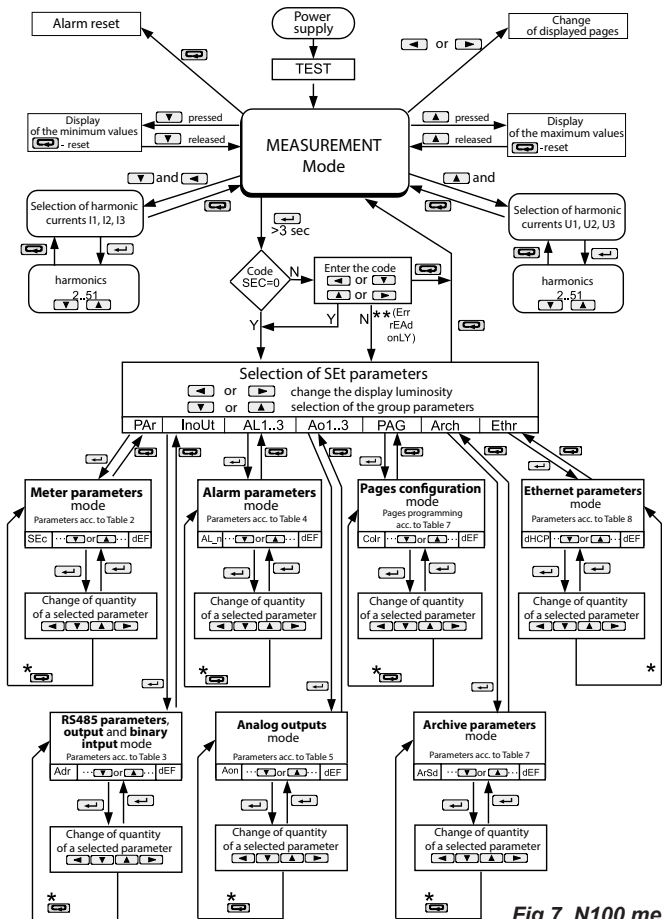



Fig 7. N100 meter operating modes







* return to a higher level without saving the changes

** (Err rEAd onLY) only preview of parameters, without the possibility of changes

6.4 MEASURING mode

In the **MEASURING** mode the values are displayed according to the pages that are preset at the factory or configured by the user in Pages Programming **PAG**.

Changing the page is done by pressing the button  or . The sequence of displayed pages is according to a table created in **PAG** mode.

Preview of the maximum or minimum values respectively is done while the button  or  is pressed down. Reset of maximum or minimum values is done by pressing the button  while viewing their values, i.e. first the button  or  and then  must be pressed.

Alarms are active if they were allocated. Note that the alarms do not need to be associated with the values displayed on the page because the change of a page would result in action on two-state outputs.

The alarm switching on is signaled by the lighting of the ALn inscription (n=1..3). The end of alarm duration at the alarm signalization latch switched on, is indicated by the pulsation of the ALn inscription (n= 1..3).

Erasing alarm signalization latch / if it was set in the Alarm parameters mode **ALn** / is done by pressing the button .

When displaying the reactive capacity power or energy, a marker indicating the load character is displayed , there is no mark for inductive load.

When displaying the active power, the sign „-“ is displayed for active energy export or no mark for active energy import.

Exceeding of the upper or lower indication range is signaled on the display by upper or lower horizontal lines. For measurement of the averaged values (P Demand, S Demand, I Demand) single measurements are carried out with 0.25 second quantum. Averaging time to choose from: 15, 30 or 60 minutes. Until all samples of the averaged values are acquired, the values are calculated from already measured samples. Current value in the neutral wire $I_{(N)}$ is calculated from phase current vectors.

6.4.1 Measurement of voltage and current harmonics

The choice of harmonics is done by pressing the buttons

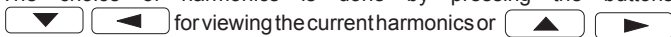

for viewing the current harmonics or

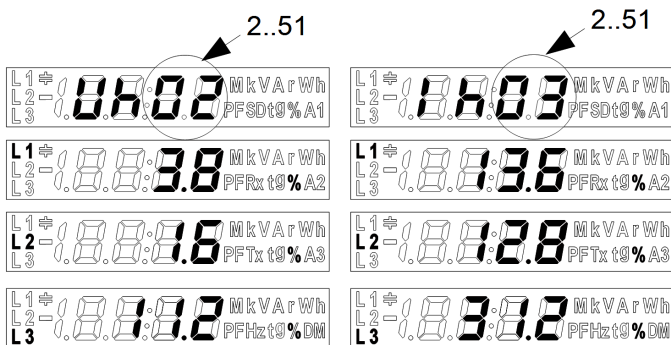

Voltage harmonics U1, U2, U3 or current harmonics I1, I2, I3 are displayed simultaneously for 3-phases. The number of displayed harmonic circled in the figure, is signaled by blinking and it can be changed in the range 2..51 by pressing or buttons. By pressing button, you can return to the measuring mode.

No. of par.	Quantity name	Marking	Unit	Signaling	3Ph /4W	3Ph /3W	Available display fields/mark (according to Fig. 11)
00	no value - blanked display	OFF			√	√	f1,f2, f3,f4
01	L1 phase voltage	U_1	(M,k)V	L1	√	x	f1,f2, f3,f4
02	L1 phase wire current	I_1	(k)A	L1	√	√	f1,f2, f3,f4
03	L1 phase active power	P_1	(M,k)W	L1	√	x	f1,f2, f3,f4 / -
04	L1 phase reactive power	Q_1	(M,k)VA _r	L1/ \oplus	√	x	f1,f2, f3,f4 / -
05	L1 phase apparent power	S_1	(M,k)VA	L1	√	x	f1,f2, f3,f4
06	L1 phase active power factor (PF1=P1/S1)	PF1	PF	L1	√	x	f1,f2, f3,f4 / -
07	tgφ factor of L1 phase (tg1=Q1/P1)	tg1	tg	L1	√	x	f1,f2, f3,f4 / -
08	L1 phase voltage THD	THD _{U1}	V%	L1	√	x	f1,f2, f3,f4
09	L1 phase current THD	THD _{I1}	A%	L1	√	x	f1,f2, f3,f4
10	L2 phase voltage	U_2	(M,k)V	L2	√	x	f1,f2, f3,f4

11	L2 phase wire current	I_{L2}	(k)A	L2	√	√	f1,f2, f3,f4
12	L2 phase active power	P_{L2}	(M,k)W	L2	√	x	f1,f2, f3,f4 / -
13	L2 phase reactive power	Q_{L2}	(M,k)VA _r	L2/ \oplus	√	x	f1,f2, f3,f4 / -
14	L2 phase apparent power	S_{L2}	(M,k)VA	L2	√	x	f1,f2, f3,f4
15	L2 phase active power factor (PF2=P2/S2)	$PF2$	PF	L2	√	x	f1,f2, f3,f4 / -
16	tgφ factor of L2 phase (tg2=Q2/P2)	$tg2$	tg	L2	√	x	f1,f2, f3,f4 / -
17	L2 phase voltage THD	V_{THD}	V%	L2	√	x	f1,f2, f3,f4
18	L2 phase current THD	I_{THD}	A%	L2	√	x	f1,f2, f3,f4
19	L3 phase voltage	U_{L3}	(M,k)V	L3	√	x	f1,f2, f3,f4
20	L3 phase wire current	I_{L3}	(k)A	L3	√	√	f1,f2, f3,f4
21	L3 phase active power	P_{L3}	(M,k)W	L3	√	x	f1,f2, f3,f4 / -
22	L3 phase reactive power	Q_{L3}	(M,k)VA _r	L3/ \oplus	√	x	f1,f2, f3,f4 / -
23	L3 phase apparent power	S_{L3}	(M,k)VA	L3	√	x	f1,f2, f3,f4
24	L3 phase active power factor (PF3=P3/S3)	$PF3$	PF	L3	√	x	f1,f2, f3,f4 / -

25	tgφ factor of L3 phase (tg3=Q3/P3)	t_{L3}	tg	L3	√	x	f1, f2, f3, f4 / -
26	L3 phase voltage THD	t_{HU3}	V%	L3	√	x	f1, f2, f3, f4
27	L3 phase current THD	t_{HI3}	A%	L3	√	x	f1, f2, f3, f4
28	mean 3-phase current	I_{-R}	(k)A	L1 L2 L3	√	√	f1, f2, f3, f4
29	3-phase active power	P	(M,k)W	L1 L2 L3	√	√	f1, f2, f3, f4 / -
30	3-phase reactive power	Q	(M,k)VAR	L1 L2 L3 / $\frac{1}{\sqrt{3}}$	√	√	f1, f2, f3, f4 / -
31	3-phase apparent power	S	(M,k)VA	L1 L2 L3	√	√	f1, f2, f3, f4
32	active power factor 3-phase (PF=P/S)	PF	PF	L1 L2 L3	√	√	f1, f2, f3, f4 / -
33	tgφ factor average for 3 phases (tg=Q/P)	t_L	tg	L1 L2 L3	√	√	f1, f2, f3, f4 / -
34	frequency	F	Hz	L1 L2 L3	√	√	f4
35	phase-to-phase voltage L1-L2	U_{12}	(M,k)V	L1 L2	√	√	f1, f2, f3, f4
36	phase-to-phase voltage L2-L3	U_{23}	(M,k)V	L2 L3	√	√	f1, f2, f3, f4
37	phase-to-phase voltage L3-L1	U_{31}	(M,k)V	L3 L1	√	√	f1, f2, f3, f4

38	mean phase-to-phase voltage	U_{123}	(M,k)V	L1 L2 L3	√	√	f1,f2, f3,f4
39	active power averaged (P Demand)	P_{dt}	(M,k)W	L1 L2 L3 DM	√	√	f4
40	reactive power averaged (S Demand)	S_{dt}	(M,k)VA	L1 L2 L3 DM	√	√	f4
41	current averaged (I Demand)	i_{dt}	(k)A	L1 L2 L3 DM	√	√	f4
42	Active 3-phase import energy	ϵ_{nP}	(M,k)Wh	L1 L2 L3	√	√	f1,f2, f3,f4
43	Active 3-phase export energy	$-\epsilon_{nP}$	(M,k)Wh	L1 L2 L3	√	√	f1,f2, f3,f4 / -
44	Reactive 3-phase inductive energy	ϵ_{nQ}	(M,k) VArh	L1 L2 L3	√	√	f1,f2, f3,f4
45	Reactive 3-phase capacity energy	$-\epsilon_{nQ}$	(M,k) VArh	L1 L2 L3/⚡	√	√	f1,f2, f3,f4/ ⚡
46	3-phase apparent energy	ϵ_{nS}	(M,k)VAh	L1 L2 L3	√	√	f1,f2, f3,f4
47	Active energy from external counter	$\epsilon_{nP\epsilon}$	(M,k)Wh		√	√	f1,f2, f3,f4
48	Date -day, month	$dd\bar{n}\bar{n}$			√	√	f1,f2, f3,f4
49	Date – year	$yyyy$			√	√	f1,f2, f3,f4
50	Time – hours, minutes	$hh\bar{n}\bar{n}$			√	√	f1,f2, f3,f4
51	Time – seconds	SS			√	√	f1,f2, f3,f4

6.5 Parameter settings

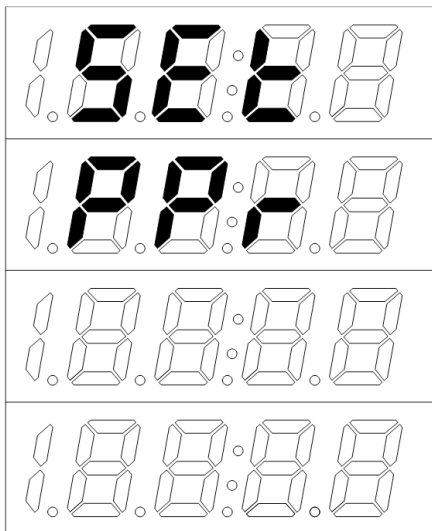







Fig. 8. The message after entering SETUP procedure

To enter SETUP procedure, press the button:  for about 3 seconds.

Use the buttons   to select an appropriate mode. Active mode **Par**, **oUt**, **Aln**, **AnOn**, **PAG**, **Eth**, or **Arch** is indicated by blinking of the appropriate symbol. Accept a selected mode by pressing the button .

Use the button to return to a measurement mode from other modes .

PAR Meter parameters	SEc Access code	con Type of the connections system	rEY1 Reversed direction of the current in phase L1	rEY2 Reversed direction of the current in phase L2	rEY3 Reversed direction of the current in phase L3	rni Input current range	tri Current ratio	trU Voltage ratio	d.t Averaging time /Demand integration time/
	Syn Averaging synchronized with the real time clock	EnD Energy counters erasing	RuD Erasing averaged parameters	dEF Default settings					
inoUt RS485 parameters, output and binary input parameters	Rdr MODBUS network address	trb Transmission mode	bRU Baud rate	Po.c Constant of pulse output	Pl.c Constant of external energy counter	t.H Hour, minute	d.ii Day, month	yyyy Year	dEF Default settings
AL1 : AL3 Alarm parameters	AL.n Value on the alarm output (Tab. 6 in user's manual)	R.t Alarm type	RoF Alarm lower limit	RoU Alarm upper limit	Rt.n Time delay of switching on	Rt.F Time delay of switching off	R.b Alarm re-activation lock	R.S Alarm signalization latch	dEF Default settings
Ro1 : Ro3 Analog outputs parameters	Ro.n Value on the analog output (Tab. 6 in user's manual)	Ro.t Analog output type	R.inL Lower value of the input range in %	R.inH Upper value of the input range in %	RoLo Lower value of the input range in mA	RoHi Upper value of the input range in mA	Ro.tr Analog output working mode	dEF Default settings	
PRU Pages configuration	Colr Color of the displays	P01 Page enable/disable. Values on next fields of the page 1	...	P20 Page enable/disable. Values on next fields of the page 20	dEF Default pages				

Fig. 9. Programming matrix part 1



Arch Archive parameters	ArSd	Arnn	Arun	Arty	Ar.L	Ar.H	Ar.t	ArdE		
	Copy the archive to the SD card	Archived values (Tab. 6 in user's manual)	Parameter triggering archiving (Tab. 6 in user's manual)	Archiving type	Archiving lower limit	Archiving upper limit	Archiving period	Deleting an internal archive		
Ethr Ethernet interface parameters	dHCP	IP-3	...	IP-0	Sn-3	...	Sn-0	dG-3	...	dG-0
	DHCP Client enable/disable	B3 byte of the IP address (IPv4)		B0 byte of the IP address (IPv4)	B3 byte of the subnet mask		B0 byte of the subnet mask	B3 byte of the default gateway address		B0 byte of the default gateway address
	Obtained from DHCP or entered manually when DHCP disabled, format B3.B2.B1.B0									
	nC-5	...	nC-0	dEF						
	B5 byte of the meter's MAC address		B0 byte of the meter's MAC address	Default settings of the Ethernet interface						
	format B5:B4:B3:B2:B1:B0									









Fig. 9. Programming matrix part 2

6.5.1 Setting of meter parameters PAR



This mode is used to determine the parameters of the meter. Entering the parameters configuration mode is protected by an access code, if entered access code is different from zero. The password prompt is skipped for code 0000. If the access code is incorrect, the message Err, rEAd, oNLY is displayed. Then it is possible to view the parameters, but the changes are not possible.

The values according to Table 2 are set in this mode.

After entering the SEt procedure, select with the button  or  **Par** mode and press .

The buttons     can be used to set the requested values i.e. the digit in the decimal position by the button  or , the digit value by the button  or .

The active position is signaled by the cursor.

Set value can be accepted by the button  or canceled by pressing .

Exit from SEt procedure will also happen after waiting for approx. 60 seconds.

Table 2

Item	Parameter name	Designation	Range	Notes/ description	Default settings
1	Access code entry	5Ee	0..9999	0 – no code	0
2	Type of connection	con	3PH.4 3PH.3	3PH-4 – 3phase, 4-wire 3PH-3 – 3phase, 3-wire	3PH.4
3	Reversed direction of the current in phase L1	reY1	no/yES		no
4	Reversed direction of the current in phase L2	reY2	no/yES		no
5	Reversed direction of the current in phase L3	reY3	no/yES		no
6	Input current range	cnI	1A, 5A	Input range: 1A or 5A	5A
7	Current transformer ratio*	ctrI	1 .. 10000		1
8	Voltage transformer ratio*	ctrU	1...4000		1
9	Averaging time /Demand integration time/	d.t	t_15, t_30, t_60	Averaging time active power P Demand reactive power S Demand current I Demand t_15, t_30, t_60	t_15
10	Averaging synchronized with the real-time clock	syn		on/OFF	oFF

11	Energy counters erasing	$\epsilon n \emptyset$	no, En P, En q, En S, En AL	no – no activity, En P – erase active energy, En q – erase reactive energy, En S – erase apparent energy, En AL – erase all energies	no
12	Erasing averaged parameters	$R \cup \emptyset$		YEs/no	no
13	Default settings	dEF	no, yES	Restoring default (factory) group settings Par	no

** - Alternatively, the current transformer ratio can be defined by providing the value of a primary and secondary current, and the voltage transformer ratio by providing the value of a primary and secondary voltage. It is defined in the registers 4130 .. 4135. The options are not available from the meter's menu. eCon program allows to define the ratio in both variants.*

Free eCon software for configuration of the N100 meters is available on the website www.lumel.com.pl.

During changing the parameters, it is check if the value is in the range. If the set value falls outside the allowable range, the value is set to the maximum value (when entered value is too high) or minimum value (when it is too low).

6.5.2 Setting the input and output parameters InoUt

Select the **InoUt** mode in options and confirm selection by pressing the button .

Table 3

Item	Parameter name	Designation	Range	Notes/ description	Default settings
1	Modbus Network Address	<i>Rdr</i>	1...247		1
2	Transmission mode	<i>t r b</i>	r8n2, r8E1, r8o1, r8n1		r8n2
3	Baud rate	<i>bRU</i>	4.8 k, 9.6 k, 19.2 k, 38.4 k, 57.6 k, 115.2 k		9.6 k
4	Constant of pulse output	<i>Po . c</i>	0..9999	Number of impulses/1kWh 0-disabled	1000
5	Constant of external energy counter	<i>Pi . c</i>	0..9999	Number of impulses/1kWh 0-disabled	1000
6	Hour, minute	<i>t . H</i>	00.00.. 23.59		00.00
7	Day, month	<i>d . n</i>	01.01 .. 31.12		1.01.2014
8	Year	<i>yyyy</i>	2014 ..2100		2014
9	Default settings	<i>dEF</i>	no, yES	Restoring default group settings InoUt	n

6.5.3 Alarm configuration ALn



In the options, select the **ALn** mode and confirm selection by pressing the button .

Table 4

Item	Parameter name	Designation	Range	Notes/ description	Default settings
1	Quantity on the alarm output	$R_{L.n}$	0..43	code as in Tab. 6 n=1..3	AL1= \overline{U} \overline{I} \overline{P} AL2= \overline{I} \overline{R} AL3= \overline{P}
2	Alarm type	$R.t$	n_on, noFF, on,oFF, H_on, HoFF, 3non, 3noF, 3_on, 3_oF	Fig. 10	n-on
3	Alarm lower limit	R_{oF}	-144.0...144.0	in % of the rated input value	90.0
4	Alarm upper limit	R_{on}	-144.0...144.0	in % of the rated input value	110.0
5	Time delay of the switch on reaction	$R_{t.n}$	0 ... 3600	in seconds	0
6	Time delay of the switch off reaction	$R_{t.F}$	0 ... 3600	in seconds	0
7	Alarm re-activation lock	$R.b$	0 ... 3600	in seconds	0

8	Alarm signalization latch	R. 5	on, oFF	<p>When alarm signalization latch function is enabled and the alarm state ends, alarm symbol is not turned off but begins to flash. Alarm symbol flashes until it is turned off by pressing the button  (> 3 sec). This function refers only to the alarm signalization, so the relay contacts will operate without a latch according to the selected alarm type.</p>	oFF
9	Default settings	dEF	no, yES	Restoring default group settings ALn	no

Entering the value Aon lower than AoF or equal switches the alarm off.

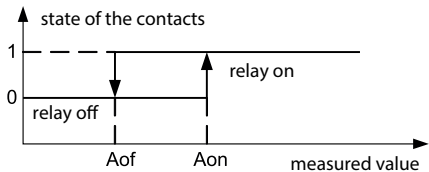

a) n_on

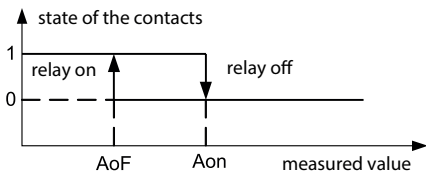

b) noFF

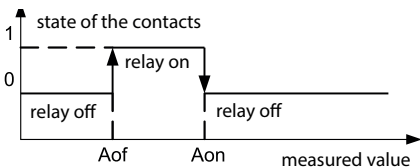

c) on

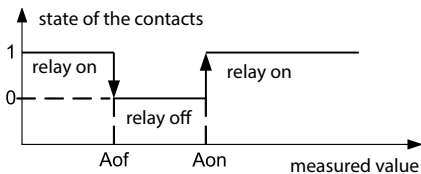



d) oFF

Fig. 10. Alarm types:

- a) n_on
- b) noFF
- c) on
- d) oFF

Remaining types of the alarm:

- H_on – always enabled;
- HoFF – always disabled,
- 3non – relay is switched on when n_on type alarm occurs on any phase It will be switched off only when all alarms are disabled.
- 3noF – relay is switched on when noFF type alarm occurs on any phase It will be switched off only when all alarms are disabled.
- 3_on – relay is switched on when on type alarm occurs on any phase It will be switched off only when all alarms are disabled.
- 3_oF – relay is switched on when oFF type alarm occurs on any phase It will be switched off only when all alarms are disabled.
- The alarm value in the series 3 alarms must be in the range: 01-09 (acc. to Table 6). They work with identical thresholds of the Aof and Aon hysteresis for each phase. The blanking of the alarm signalization latch follows after pressing buttons  and  (for about 3 seconds).

Example no 1 of alarm setting:

Set alarm **n_on** type for monitored value P – 3-phase active power.

Version: 5 A; 3 x 230/400 V. Setting the alarm on after exceeding 3800 W, switching the alarm off after power drops to 3100 W.

Calculations: rated 3-phase active power: $P = 3 \times 230 \text{ V} \times 5 \text{ A} = 3450 \text{ W}$

3450 W – 100 % 3450 W – 100 %

3800 W – Aon % 3100 W – AoF %

In conclusion: Aon = 110,1 % AoF = 89,9 %

Set: Monitored value: P. Alarm type: n_on, Aon 110,1, AoF 89.9.

6.5.4 Analog outputs configuration Ao_n

In the options, select the **Ao_n** mode and confirm selection by pressing the button .

Table 5

Item	Parameter name	Designation	Range	Notes/ description	Default settings
1	Value on the continuous output	<i>Ao_n</i>	0..43	code as in Tab. 6 <i>n=1..3 for the versions 3 outputs analog, 1 relay n=1 for the versions 3 outputs relay, 1 analog</i>	<i>Ao_1=U 123 Ao_2=I . R Ao_3=P</i>
2	Continuous output range	<i>Ao_t</i>	0-20, 4-20, -20.20		0-20
3	Lower value of the input range in % of the rated range	<i>R_inL</i>	-144.0 .. 144.0	in %	0.0
4	Upper value of the input range in % of the rated range	<i>R_inH</i>	-144.0 .. 144.0%	in %	100.0
5	Lower value of the output range	<i>AoLo</i>	-20.00 .. 20.00	in mA	0.00
6	Upper value of the output range	<i>AoHo</i>	0.01 .. 20.00	in mA	20.00

7	Output working mode	<i>Rotr</i>	nor, AoLo, AoHi	Continuous output working mode: nor – normal work, AoLo – set value AoLo, AoHi - set value AoHi,	nor
8	Default settings	<i>dEF</i>	no, yES	restoring default group settings Inout	no

Selection of the values on the alarm outputs, analog and archived:

Table 6

Item / value in the register 4014, 4022, 4032, 4038, 4045, 4052	Displayed element	Quantity type	Value needed for calculations of percentage of the alarm values (100%)
00	<i>oFF</i>	no value/alarm or output disabled	none
01	<i>U . I</i>	L1 phase voltage	Un [V] *
02	<i>I . I</i>	L1 phase wire current	In [A] *
03	<i>P . I</i>	L1 phase active power	Un x In x cos(0°) [W] *
04	<i>q . I</i>	L1 phase reactive power	Un x In x sin(90°) [Var] *

05	S_1	L1 phase apparent power	$U_n \times I_n$ [VA] *
06	PF_1	L1 phase power factor (PF)	1
07	$\tan \phi_1$	tgφ factor of L1 phase	1
08	$\%THD_{U1}$	L1 phase voltage THD	100,00%
09	$\%THD_{I1}$	L1 phase current THD	100,00%
10	U_2	L2 phase voltage	U_n [V] *
11	I_2	L2 phase wire current	I_n [A] *
12	P_2	L2 phase active power	$U_n \times I_n \times \cos(0^\circ)$ [W] *
13	Q_2	L2 phase reactive power	$U_n \times I_n \times \sin(90^\circ)$ [Var] *
14	S_2	L2 phase apparent power	$U_n \times I_n$ [VA] *
15	PF_2	L2 phase active power factor PF	1
16	$\tan \phi_2$	tgφ factor of L2 phase	1
17	$\%THD_{U2}$	L2 phase voltage THD	100,00%
18	$\%THD_{I2}$	L2 phase current THD	100,00%
19	U_3	L3 phase voltage	U_n [V] *
20	I_3	L3 phase wire current	I_n [A] *
21	P_3	L3 phase active power	$U_n \times I_n \times \cos(0^\circ)$ [W] *
22	Q_3	L3 phase reactive power	$U_n \times I_n \times \sin(90^\circ)$ [Var] *
23	S_3	L3 phase apparent power	$U_n \times I_n$ [VA] *
24	PF_3	L3 phase active power factor PF	1
25	$\tan \phi_3$	tgφ factor of L3 phase	1
26	$\%THD_{U3}$	L3 phase voltage THD	100,00%
27	$\%THD_{I3}$	L3 phase current THD	100,00%
28	I_R	mean 3-phase current	I_n [A] *
29	P	3-phase active power (P1+P2+P3)	$3 \times U_n \times I_n \times \cos(0^\circ)$ [W] *
30	Q	3-phase reactive power (Q1+Q2+Q3)	$3 \times U_n \times I_n \times \sin(90^\circ)$ [Var] *

31	S	3-phase apparent power (S1+S2+S3)	$3x U_n x I_n$ [VA] *
32	PF	3-phase power factor (PF)	1
33	$t\phi$	tgφ factor for 3 phases	1
34	$tHUR$	3-phase voltage THD	100,00%
35	$tHIR$	3-phase current THD	100,00%
36	F	frequency	100 [Hz]
37	U_{12}	phase-to-phase voltage L1-L2	$\sqrt{3} U_n$ [V] *
38	U_{23}	phase-to-phase voltage L2-L3	$\sqrt{3} U_n$ [V] *
39	U_{31}	phase-to-phase voltage L3-L1	$\sqrt{3} U_n$ [V] *
40	U_{123}	mean phase-to-phase voltage	$\sqrt{3} U_n$ [V] *
41	P_{dt}	active power averaged (P Demand)*	$3 x U_n x I_n x \cos(0^\circ)$ [W] *
42	S_{dt}	reactive power averaged (S Demand)*	$3 x U_n x I_n$ [VA] *
43	I_{dt}	current averaged (I Demand) *	I_n [A] *

*Un, In - rated values of voltages and currents

6.5.5 Pages configuration PAG

The meter allows to program 1..20 pages displayed during the measurement mode, or you can select 10 pre-programmed pages. Monitoring values are shown in Table 1.

It is possible to display 4 values on each page. Pages 2...20 can be enabled (on) or disabled (off). There is no way to disable page 1. There are 10 pages pre-defined and enabled (see Table 8).

Table 7





Item	Parameter name	Designation	Range	Notes/ description	Default settings
1	Color of the displays	<i>Color</i>	<i>red</i> , <i>green</i>	<i>red</i> =red, <i>green</i> =green	<i>red</i>
3	Defined page	<i>P01</i> : : <i>P20</i>	1..20	<i>on</i> - displayed page <i>off</i> - a page excluded from displaying Pressing the button  allows to select a displayed value on the individual fields for the enabled pages (on).	Table 1
9	Default settings	<i>DEF</i>	no, yES	Restoring default group settings PAG	no

In the options, select the **PAG** mode and confirm your choice by pressing the button .

Select the page to edit and accept by pressing the button . After accepting the value on, the names of selected values are displayed on the individual fields. Or off when no value is selected for a field.

f1→			U	_	1
f2→			U	_	2
f3→			U	_	3
f4→					F

Fig. 11. Example of defining a page

The cursor (a flashing name of the monitored value from Table 1) is positioned on the first field **f1**. Use the buttons   to select a value on a selected field and confirm a selection by pressing the button . The cursor is set to the next field. Confirm a selection and save a page after setting the required values on the fields **f1-f4** by pressing the button  and move to define the next page.

Default settings of the displayed pages. The pages 11..20 are disabled

Table 8

P01	P02	P03	P04	P05
U1V	U12V	I1A	P1W	PF1PF
U2V	U23V	I2A	P2W	PF2PF
U3V	U31V	I3A	P3W	PF3PF
F Hz	U123V	I5A	PW	PF PF

P06	P07	P08	P09	P10
P W	ᐸᓂP Wh	ᐸHU 1 V%	ᐸHI 1 A%	ᐸᐸᓂᓂ
q VAr	ᐸᓂq VArh	ᐸHU2 V%	ᐸHI 2 A%	ᐸᐸᐸᐸ
S VA	ᐸᓂS VAh	ᐸHU3 V%	ᐸHI 3 A%	ᐸᐸᓂᓂ
ᐸᐸ tg	Pᐸᐸ W	Sᐸᐸ VA	i ᐸᐸ A	SS

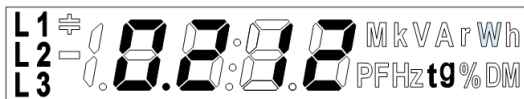

Fig.12 Visualization of the manufacturer's page P06

6.5.6 Archiving configuration Arch

In the options, select the **Arch** mode and confirm selection by pressing the button .

Table 9

Item	Parameter name	Designation	Range	Notes/ description	Default value
1	Archived values	<i>Ar_on</i>	1 ..16	acc. to Table 6	0
2	Value triggering an archiving	<i>Ar_uv</i>	0 ..43	acc. to Table 6 0 – archive off	0
3	Archiving type - archiving on condition	<i>Ar_t y</i>	n_on, noFF, H_on, on,oFF, HoFF, 3non, HoFF, 3noF, 3_on, 3_oF	Fig. 13	HoFF
4	Archiving lower limit	<i>Ar_L</i>	-144,0...144,0	in % of the rated triggering value	90
5	Archiving upper limit	<i>Ar_H</i>	-144,0...144,0	in % of the rated triggering value	110
6	Archiving period	<i>Ar_t</i>	1 ... 3600	in seconds	1
7	Deleting an internal archive	<i>Ar_dE</i>	no, yES		no

Entering the value *Ar_H* lower than *Ar_L* or equal switches the registration off. Not applicable for H_on mode.

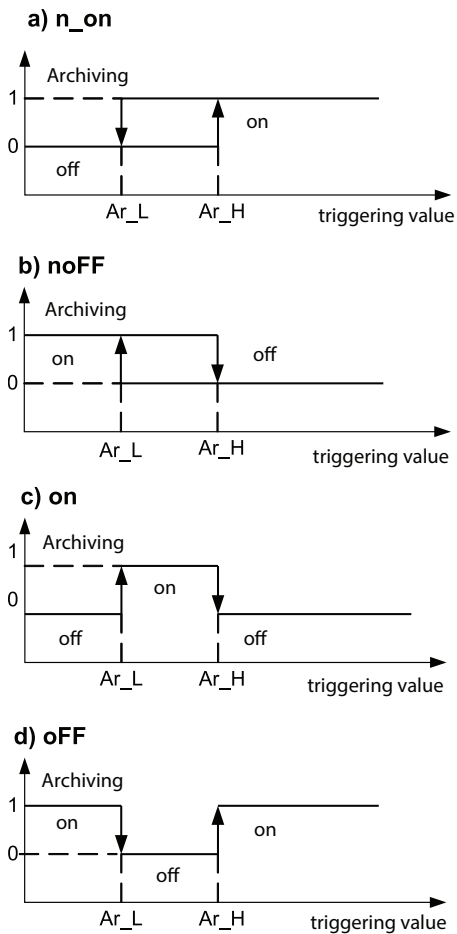

Fig. 13. Archiving types: a) n_on b) noFF c) on d) OFF

Remaining types of the archiving:

- **H_on** – always enabled;
- **HoFF** – always disabled,
- **3non** – archiving is enabled when n_on type condition occurs on any phase. It will be switched off only when all triggering condition are disabled.
- **3noF** – archiving is enabled when noFF type condition occurs on any phase. It will be switched off only when all triggering condition are disabled.
- **3_on** – archiving is enabled when on type condition occurs on any phase. It will be switched off only when all triggering condition are disabled.
- **3_oF** – archiving is enabled when oFF type condition occurs on any phase. It will be switched off only when all triggering condition are disabled.
- The value triggering an archiving in the series 3 archiving must be in the range: 01-09 (acc. to Table 6). Archiving works with identical thresholds of the Aof and Aon hysteresis for each phase.

6.5.7 Ethernet settings configuration Ethr

In the options, select the **Ethr** mode and confirm selection by pressing the button .

Table 10

Item	Parameter name	Designation	Range	Notes/description	Default value
1	Enabling / disabling the DHCP Client (supports automatic obtaining of IP protocol parameters of the meter's Ethernet interface from external DHCP servers in the same LAN)	<i>dhcp</i>	no, yES	no - DHCP disabled - you should manually configure the IP address and subnet mask of the meter; yES - DHCP enabled, the meter will automatically receive the IP address, subnet mask, and gateway address from the DHCP server when switching the supply on or selecting APPL option from the menu. The gateway address is the address of the server that assigned the parameters to the meter;	yES

2	Third byte (B3) of the meter's IP address, a value is displayed in decimal format, IPv4 address format: B3.B2.B1.B0	<i>IP-3</i>	000 ...255	when dHCP=no write and read out of parameters is possible when dHCP=YES only read out of parameters is possible	192
3	Second byte (B2) of the meter's IP address	<i>IP-2</i>	000 ...255		168
4	First byte (B1) of the meter's IP address	<i>IP-1</i>	000 ...255		1
5	Zero byte (B0) of the meter's IP address	<i>IP-0</i>	000 ...255		100
6	Third byte (B3) of the meter's subnet mask, a value is displayed in decimal format, mask address format: B3.B2.B1.B0	<i>Sn-3</i>	000 ...255		255
7	Second byte (B2) of the meter's subnet mask	<i>Sn-2</i>	000 ...255		255
8	First byte (B1) of the meter's subnet mask	<i>Sn-1</i>	000 ...255		255
9	Zero byte (B1) of the meter's subnet mask	<i>Sn-0</i>	000 ...255		0
10	Third byte (B3) of the meter's default gateway, a value is displayed in decimal format, gateway address format: B3.B2.B1.B0	<i>dG-3</i>	000 ...255		192
11	Second byte (B2) of the meter's default gateway	<i>dG-2</i>	000 ...255		168
12	First byte (B1) of the meter's default gateway	<i>dG-1</i>	000 ...255		1
13	Zero byte (B1) of the meter's default gateway	<i>dG-0</i>	000 ...255		1

14	Fifth byte (B5) of the meter's MAC address, a value is displayed in decimal format; format B5:B4:B3:B2:B1:B0	<i>ñĹ - 5</i>	000 ...255	only readout of parameters	-
15	Fourth byte (B4) of the meter's MAC address	<i>ñĹ - 4</i>	000 ...255		-
16	Third byte (B3) of the meter's MAC address	<i>ñĹ - 3</i>	000 ...255		-
17	Second byte (B2) of the meter's MAC address	<i>ñĹ - 2</i>	000 ...255		-
18	First byte (B1) of the meter's MAC address	<i>ñĹ - 1</i>	000 ...255		-
19	Zero byte (B0) of the meter's MAC address	<i>ñĹ - 0</i>	000 ...255		-
20	Saving the new parameters of the Ethernet interface	<i>ŕŕŕĹ</i>	no, yES	yES - saving the new parameters and initiate the Ethernet interface no – no changes	
21	Default settings	<i>đĚF</i>	no, yES	Restoring default group settings Ethr	no

7. MEASURING VALUES ARCHIVING

7.1. INTERNAL MEMORY

The N100 meters with Ethernet interface and internal memory file system are equipped with an internal memory and 8GB SD memory for storing the recorded data. The internal memory allows to register 40 960 records. The memory is a ring buffer type one. 8GB SD memory allows to register about 18 million records.

7.2. COPYING ARCHIVE TO SD CARD

The recorded data is copied to SD card if the internal memory is full at 70% (28 672 records) or it can be forced at any time (select the parameter **ArSd** and set to **YES** in the **Arch** mode of the **Set** procedure). To start the procedure of copying archive to the SD card can also be done via the RS485 interface (register 4079).

Example: SD card with archiving period of 5 seconds allows you to register data for 3 years. The SD LED lights up red when the SD card is full at 70% (see: **Status 3 Register – address 4118**).

The N100 meter creates the directories and the files on the memory card while the archive is being copied.

To copy the records takes up to 20 minutes depending on the number of the records. Downloading the archived files from a FTP server extends a time of a copy.

Server zdalny: /1409001/2014/12

Nazwa pliku	Rozmiar pliku	Typ pliku	Data modyfikacji	Prawa dost...	Właściciel/...
16132711.CSV	4 059 517	OpenOffic..	2014-12-17	-r--r--r--	0 0
17075806.CSV	471 087	OpenOffic..	2014-12-17	-r--r--r--	0 0
17081955.CSV	290 929	OpenOffic..	2014-12-17	-r--r--r--	0 0
17083224.CSV	211 927	OpenOffic..	2014-12-17	-r--r--r--	0 0

4 pliki. Całkowity rozmiar: 5 033 560 bajtów

Fig. 14. The directory structure on the SD card

Data on the SD card are stored in the files in the directories (year, month archive copy) - see Figure 14. The file names are marked by day and time of first record copy and have the ddhhmmss.csv format, where: dd-day, hh-hour, mm-minute, ss-second.

7.3 ARCHIVE FILES STRUCTURE

The archived data files on the SD card are in the form of the columns, where each column of data is separated by a comma. A column description is in the first line of the file. Data records are sequentially arranged in the rows. An example of the file is shown in Figure 15.

Plik	Edycja	Format	Widok	Pomoc						
date,	time,	record	index,	block,	register1,	name1,	value1,	..	register16,	name1
2014-12-17,	08:32:24,	0000512808,	0,	7500,	U_1,	2.237693F+02,	..	7519,	I_3,	0.000
2014-12-17,	08:32:25,	0000512809,	0,	7500,	U_1,	2.237693F+02,	..	7519,	I_3,	0.000
2014-12-17,	08:32:26,	0000512810,	0,	7500,	U_1,	2.240464F+02,	..	7519,	I_3,	0.000
2014-12-17,	08:32:27,	0000512811,	0,	7500,	U_1,	2.241046E+02,	..	7519,	I_3,	0.000
2014-12-17,	08:32:28,	0000512812,	0,	7500,	U_1,	2.243908F+02,	..	7519,	I_3,	0.000
2014-12-17,	08:32:29,	0000512813,	0,	7500,	U_1,	2.240464E+02,	..	7519,	I_3,	0.000
2014-12-17,	08:32:30,	0000512814,	0,	7500,	U_1,	2.243908E+02,	..	7519,	I_3,	0.000
2014-12-17,	08:32:31,	0000512815,	0,	7500,	U_1,	2.241046E+02,	..	7519,	I_3,	0.000
2014-12-17,	08:32:32,	0000512816,	0,	7500,	U_1,	2.246347E+02,	..	7519,	I_3,	0.000
2014-12-17,	08:32:33,	0000512817,	0,	7500,	U_1,	2.246347E+02,	..	7519,	I_3,	0.000
2014-12-17,	08:32:34,	0000512818,	0,	7500,	U_1,	2.244283E+02,	..	7519,	I_3,	0.000
2014-12-17,	08:32:35,	0000512819,	0,	7500,	U_1,	2.244283E+02,	..	7519,	I_3,	0.000
2014-12-17,	08:32:36,	0000512820,	0,	7500,	U_1,	2.243908E+02,	..	7519,	I_3,	0.000
2014-12-17,	08:32:37,	0000512821,	0,	7500,	U_1,	2.246347E+02,	..	7519,	I_3,	0.000
2014-12-17,	08:32:38,	0000512822,	0,	7500,	U_1,	2.246347E+02,	..	7519,	I_3,	0.000
2014 12 17,	08:32:39,	0000512823,	0,	7500,	U_1,	2.246523E+02,	..	7519,	I_3,	0.000
2014 12 17,	08:32:40,	0000512824,	0,	7500,	U_1,	2.246523E+02,	..	7519,	I_3,	0.000
2014 12 17,	08:32:41,	0000512825,	0,	7500,	U_1,	2.244662E+02,	..	7519,	I_3,	0.000

Fig. 15. An example of the archive data file

The fields in the line describing the record have the following meanings:

- date – date of data recording, date separator is the character „-“
- time – hour, minute, second of recorded data, a time separator is the character „:“
- record index – unique index record. Each record has a unique number. This number increases when writing new records.
- block – reserved
- register1 – Modbus register address of the first archived value
- name1 – Modbus register description of the first archived value
- value1 – first archived value. The decimal separator is „.“, the values are saved in a engineering notation format.
- :
- register16 – Modbus register address of the sixteenth archived value
- name16 – Modbus register description of the sixteenth archived value
- value16 – sixteenth archived value. The decimal separator is „.“, the values are saved in a engineering notation format.

name1, ...,name16 – description according to Table 6 (Displayed parameter).

7.4 DOWNLOADING ARCHIVE FROM SD CARD

Archived data is stored in the files. The files can be downloaded via Ethernet using FTP.

8. SERIAL INTERFACES

8.1 RS485 INTERFACE – LIST OF PARAMETERS

The implemented protocol is compliant with the PI-MBUS-300 Rev G specification of Modicon. List of N100 meter serial interface parameters:

- identifier 0xD6
- meter address 1..247,
- baud rate 4.8, 9.6, 19.2, 38.4, 57.6, 115.2 kbit/s,
- operating mode Modbus RTU,
- transmission mode 8N2, 8E1, 8O1, 8N1,
- max. response time 600 ms,
- max. no. of registers read in a single query
 - 61 registers – 4-byte registers,
 - 122 registers – 2-byte registers,
- implemented functions 03, 04, 06, 16, 17,
 - 03, 04 register readout
 - 06 single register writing,
 - 16 writing of n-registers,
 - 17 device identification,

Default settings: address 1, baud rate 9.6 kbit/s, mode RTU 8N2

8.2 EXAMPLES OF REGISTERS' READOUT AND WRITE

Readout of n-registers (code 03h)

Example 1. Readout of two 16-bit integer registers, starting with the register address 0FA0h (4000) - register values 10, 100.

Request:

Device address	Function	Register address		Number of registers		CRC checksum
		B1	B0	B1	B0	
01	03	0F	A0	00	02	C7 3D

Response:

Device address	Function	Number of bytes	Register address		Number of registers		CRC checksum
			B1	B0	B1	B0	
01	03	04	00	0A	00	64	E4 6F

Example 2. Readout of two 32-bit float registers as a combination of two 16-bit registers, starting with the register address 1B58h (7000) - register values 10, 100.

Request:

Device address	Function	Register address		Number of registers		CRC checksum
		B1	B0	B1	B0	
01	03	1B	58	00	04	C3 3E

Response:

Device address	Function	Number of bytes	Value from the register 1B58 (7000)		Value from the register 1B59 (7001)		Value from the register 1B5A (7002)		Value from the register 1B5B (7003)		CRC checksum
			B3	B2	B1	B0	B3	B2	B1	B0	
01	03	08	41	20	00	00	42	C8	00	00	E4 6F

Example 3. Readout of two 32-bit float registers as a combination of two 16-bit registers, starting with the register address 1770h (6000) - register values 10, 100.

Request:

Device address	Function	Register address		Number of registers		CRC checksum
		B1	B0	B1	B0	
01	03	17	70	00	04	4066

Response:

Device address	Function	Number of bytes	Value from the register 1B58 (7000)		Value from the register 1B59 (7001)		Value from the register 1B5A (7002)		Value from the register 1B5B (7003)		CRC checksum
			B3	B2	B1	B0	B3	B2	B1	B0	
01	03	08	41	20	00	00	42	C8	00	00	E4 6F

Example 4. Readout of two 32-bit float registers, starting with the register address 1D4Ch (7500) - register values 10, 100.

Request:

Device address	Function	Register address		Number of registers		CRC checksum
		B1	B0	B1	B0	
01	03	1D	4C	00	02	03 B0

Response:

Device address	Function	Number of bytes	Value from the register 1D4C (7500)				Value from the register 1D4D (7501)				CRC checksum
			B3	B2	B1	B0	B3	B2	B1	B0	
01	03	08	41	20	00	00	42	C8	00	00	E4 6F

Single register writing (code 06h)

Example 5. Writing the value 543 (0x021F) to the register 4000 (0x0FA0)

Request:

Device address	Function	Register address		Number of registers		CRC checksum
		B1	B0	B1	B0	
01	06	0F	A0	02	1F	CA 54

Response:

Device address	Function	Register address		Number of registers		CRC checksum
		B1	B0	B1	B0	
01	06	0F	A0	02	1F	CA 54

Writing to n-registers (code 10h)

Example 6. Writing two registers starting with the register address 0FA3h (4003)

Writing the values 20, 2000.

Request:

Device address	Function	Address reg. Hi	Address reg. Lo	Address reg. Hi	Address reg. Lo	Number of bytes	Value for the register 0FA3 (4003)		Value for the register 0FA4 (4004)		CRC checksum
							B1	B0	B1	B0	
01	10	0F	A3	00	02	04	00	14	07	D0	BB 9A

Response:

Device address	Function	Register address		Number of registers		CRC checksum
		B1	B0	B1	B0	
01	10	0F	A3	00	02	B2 FE

Device identification report (code 11h)

Example 7. Device identification

Request:

Device address	Function	CRC checksum
01	11	C0 2C

Response:

Device address	Function	Number of bytes	Identifier	Device status	Information field of the device software version (e.g. „N100-1.00 b-1.06” - N100 device with software version 1.00 and bootloader version 1.06)	CRC checksum
01	11	19	CF	FF	4E 34 33 20 2D 31 2E 30 30 20 20 20 20 20 20 20 62 2D 31 2E 30 36 20	E0 24

8.3 Ethernet interface 10/100-BASE-T

The N100 meters version N100-XX1XXXX are equipped with an Ethernet interface for connecting the meter (using the RJ45 socket) to the local or global network (LAN or WAN). The Ethernet interface allows to use the web services implemented in the meter: web server, FTP server, Modbus TCP/IP. Configure *Eth* group parameters to use the meter's network services. The standard Ethernet parameters of the meter are shown in Table 10. The main parameter is the IP address of the meter, by default 192.168.1.100, which must be unique in a network the device will be connected to. The IP address can be assigned to the meter automatically by the DHCP server present in the network if the meter has an option to obtain an address from DHCP server enabled: *Eth* → *DHCP* → *YES*. If the DHCP service is disabled then the meter will work with the default IP address allowing the user to change the IP address, e.g. from the menu of the meter. Any change of the Ethernet parameters requires the confirmation e.g. from the menu *Eth* → *APPL* → *YES* or entering the value „1” to the register 4099. The Ethernet interface is rebooted in accordance with the new parameters after applying changes - all services of the Ethernet interface are restarted.

8.3.1 Connecting 10/100-BASE-T interface

Connect the device to a TCP/IP network using the RJ45 socket located at the back / terminal side / of the meter to get access to the Ethernet services.

The meter's RJ45 socket LEDs description:

- yellow LED - illuminates when the meter is properly connected to the Ethernet 100 Base-T, does not illuminate when the meter is not connected to a network or is connected to a 10-Base-T.
- green LED - Tx/Rx, illuminates (irregularly illuminates) when the meter sends and receives data, illuminates continuously when no data is transmitted

It is recommended to use a twisted pair cable to connect the meter to the network:

- U/FTP – twisted pair cable with a separate foil for every pair,
- F/FTP – twisted pair cable with separate foil for every pair and additional foil shielding for the cable,
- S/FTP (former SFTP) – twisted pair cable with separate foil for every pair and additional mesh cable shielding,
- SF/FTP (former S-STP) – twisted pair cable with separate foil for every pair and additional mesh and foil cable shielding.

The twisted pair cable categories according to the European standard EN 50173 are minimum: Class D (category 5) - for high-speed local area networks, includes the applications using the frequency band up to 100 MHz. For Ethernet connection use the category 5 STP type twisted-pair cable (shielded) with RJ-45 connector, wiring colors (according to Table 11), compliant to the following standards:

- EIA/TIA 568A for both connectors in strike-through connection (i.e. between N100 and hub or switch),
- EIA/TIA 568A for the first connector and EIA/TIA 568B for the second one in the cross-over connection (i.e. when connecting the N100 meter to the computer).

Table 11

Wire no.	Signal	Wire color according to the standard	
		EIA/TIA 568A	EIA/TIA 568B
1	TX+	white-green	white-orange
2	TX-	green	orange
3	RX+	white-orange	white-green
4	EPWR+	blue	blue
5	EPWR+	white-blue	white-blue
6	RX-	orange	green
7	EPWR-	white-brown	white-brown
8	EPWR-	brown	brown

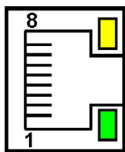

Fig. 16. View and pin numbering of the RJ45 socket

8.3.2 WWW Server

The N100 meter provides its own web server which enables remote monitoring of the measuring values, remote configuration and reading a status of the meter. A web page allows in particular to:

- obtain information about the device (serial number, code execution, software version, bootloader version, version (standard or special),
- preview current measuring values,
- read a device status,
- select the web page language

You can access the web server using a web browser by entering the IP address of the meter, e.g.: `http://192.168.1.100` (where 192.168.1.100 is set IP address of the meter). The default web server port is the port „80“. The server port can be changed by the user.

Caution: A browser with JavaScript enabled and compatible with XHTML 1.0 is required for correct operation of the website (all popular browsers, Internet Explorer version 8 minimum).

8.3.2.1 General view

Meter N100		LUMEL					
Measured values	Measured energy values	Measured (min/max) values	Ethernet	RS-485 Modbus	Status	About N100	Logout (admin —)
Refresh mode : <input checked="" type="checkbox"/>							
Measured values							
Parameter	Value	Parameter	Value	Parameter	Value		
U L1	26.268 V	U L2	26.252 V	U L3	26.236 V		
I L1	0.068028 A	I L2	0.067727 A	I L3	0.067558 A		
P L1	1.7865 W	P L2	1.7769 W	P L3	1.7714 W		
Q L1	0 var	Q L2	0 var	Q L3	0 var		
S L1	1.787 VA	S L2	1.7779 VA	S L3	1.7725 VA		
PF L1	0.99972	PF L2	0.99944	PF L3	0.99941		
tgφ L1	0	tgφ L2	0	tgφ L3	0		
THD U1	6.0728 %	THD U2	6.0663 %	THD U3	6.0745 %		
THD I1	3.4794 %	THD I2	3.5333 %	THD I3	3.5234 %		

Measured values			
Parameter	Value	Parameter	Value
U avg(3phase)	26.252 V	f	50.014 Hz
I avg(3phase)	0.067771 A	U L1-2	0 V
ΣP(3phase)	5.3348 W	U L2-3	0 V
ΣQ(3phase)	0 var	U L3-1	0 V
ΣS(3phase)	5.3374 VA	U avg interphases	0 V
PF(3phase)	0.99952	P demand	0 W
tgφ(3phase)	0	S demand	0 VA
THD U avg (3phase)	6.0712 %	I demand	0 A
THD I avg (3phase)	3.512 %	Neutral current	0.00069576 A

Fig. 17 View of the meter website

8.3.2.2 Web user selection

The meter has two user accounts for the web server protected by the individual passwords:

- user: „**admin**”, password: „**admin**” - access to the configuration and preview of the parameters
- user: „**user**”, password: „**pass**” - access only to the preview of the parameters

Calling the IP address of the meeter in a browser, e.g. <http://192.168.1.100> will display a start website to enter a user name and a password.



Login

Username

Password

Login

Fig. 18. View of the meter's web server login window

The web server user name can not be changed. You can change the password for each user - for safety reasons it is recommended to change the passwords. Changing the password is possible only through a web page in the „Ethernet“ parameter group. The passwords can be up to 8 characters. If the password is lost (what disables using the web server), restore the default settings of the Ethernet interface e.g. from the menu: *E t h e r* → *d e f* → *y e s* or by entering the value „1“ to the register 4100. All standard Ethernet interface parameters (see Table 10) and the passwords of the web server users will be restored: user „**admin**“ → password: „**admin**“ ; user „**user**“ → password „**pass**“.

The session lasted five minutes opens when you log in to the web server. After this time, a user will be automatically logged out from a web server. The change of the group parameters renews time to expiry of the session.

8.3.3 Serwer FTP

The FTP file sharing protocol has been implemented in the N100 meters. The meter acts as a server, allowing the users to access the internal memory of its file system. Access to the files is possible using a computer, a tablet with installed FTP client or other device acting as a FTP client. The standard FTP ports are used for transferring files, „20” - data port and „21” -- commands port. A user can change the port used by the FTP protocol if necessary. Please note, that the port configuration of the FTP server and the client must be the same.

The FTP client program can work in either active or passive mode. It is recommended to set the passive mode, because the connection is fully made by the FTP client (a client chooses the data port). The server in active mode determines the choice of the data port., e.g. port „20”. It is possible to use of up to one connection at the same time for the file transfer, so you should limit the maximum number of a FTP client connections to „1”.

The FTP server closes the connection if the client is idle for over 1 minute.

8.3.3.1 FTP user selection

The meter has two user accounts for the FTP server protected by the individual passwords:

- user: „**admin**”, password: „**admin**” - access to read and write the files
- user: „**user**”, password: „**passftp**” - access to read only the archive files.

The FTP user names can not be changed but you can change the password for each user - for safety reasons it is recommended to change the passwords. Changing the password is possible only through a web page in the „Ethernet” parameter group. The passwords can be up to 8 characters. If the password is lost (what disables using the FTP server), restore the default settings of the Ethernet interface e.g. from the menu: *E t h r* → *d E F* → *4 E 5* , or by entering the value „1” to the register 4100. All standard Ethernet interface parameters (see Table 10) and the passwords of the FTP server users will be restored:

user „**admin**” → password: „**admin**” ;

user „**user**” → password „**passftp**”.

The program FileZilla could be an example of the FTP client. You can view and download the archive files by entering the IP address of the meter in the address field.

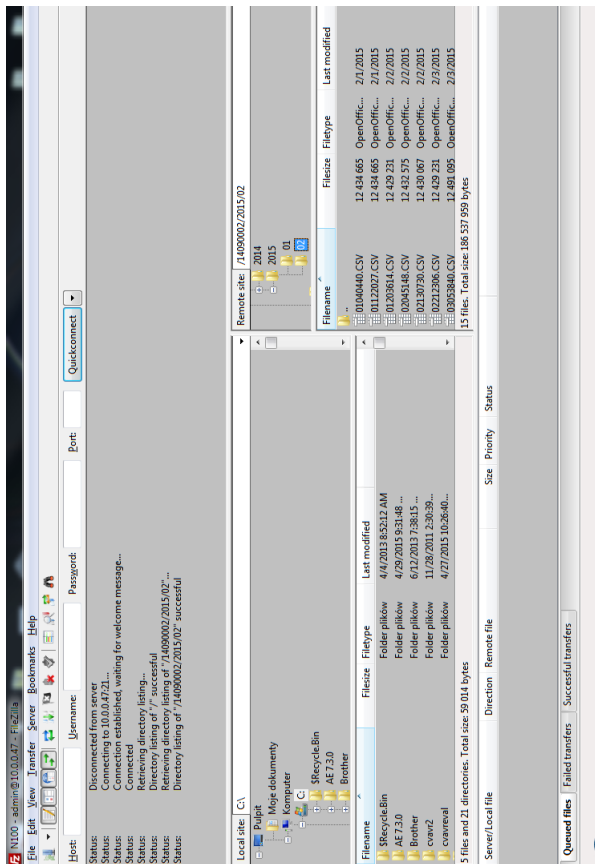

Fig. 19. View of the FTP session in the program FileZilla

8.3.4 Modbus TCP/IP

The N100 meter allows access to the internal registers via the Ethernet interface and Modbus TCP/IP Slave protocol. It is necessary to set the unique IP address of the meter and set the connection parameters listed in Table 12 to set up a connection.

Table 12

Register	Description	Default value
4096	Device address for Modbus TCP/IP protocol	1
4097	Modbus TCP port number	502
4095	Port closing time of Modbus TCP/IP service [s]	60
4094	The maximum simultaneous connections to Modbus TCP/IP service	4

The device address is the address of the device for Modbus TCP/IP protocol and is not a value equal to a address value for Modbus RS485 protocol (Modbus network address register 4059). When deleting the parameter „Device address for Modbus TCP/IP protocol” of the meter to the value „255”, the meter will skip the address analysis in the frame of Modbus protocol (broadcast mode).

8.4 Map of N100 meter registers

In the N100 meter, data are placed in 16 and 32-bit registers. Process variables and meter parameters are placed in the address area of registers in a way depended on the variable value type. Bits in 16-bit register are numbered from the youngest to the oldest (b0-b15). The 32-bit registers contain numbers of float type in IEEE-754 standard. 3210 byte order - the oldest is sent first.

Table 13

Address range	Value type	Opis
4000 – 4151	Integer (16 bits)	Value set in the 16-bit register. Registers for meter configuration. Description of registers is shown in Table 12. Registers for writing and readout.
4300 - 4385	Integer (16 bits)	Value set in the 16-bit register. Registers for displayed pages configuration. Description of registers is shown in Table 13. Registers for writing and readout.
6000 – 6907	Float (2x16 bits)	Value is set in the two following 16-bit registers. Registers contain exactly the same data, as 32-bit registers of 7500 – 7952 range. Readout registers. Bytes sequence (1-0-3-2)
7000 – 7301 8002 - 8607	Float (2x16 bits)	Value is set in the two following 16-bit registers. Registers contain exactly the same data, as 32-bit registers of 7500 – 7952 range. Readout registers. Bytes sequence (3-2-1-0)
7500 – 7953	Float (32 bits)	Value set in the 32-bit register. Description of registers is shown in Table 14. Readout registers.

Table 14

Register address	Operations	Range	Description	Default
4000	RW	0...9999	Protection - password	0
4001	RW	0	reserved	0
4002	RW	0..7	Bit 0 - „1” reversed direction of the current in phase L1 Bit 1 - „1” reversed direction of the current in phase L2 Bit 2 - „1” reversed direction of the current in phase L3	0
4003	RW	0 .. 1	Type of connection 0 - 3Ph/4W 1 - 3Ph/3W	0
4004	RW	0,1	Input range: 1 A or 5 A: 0 - 1 A, 1 - 5 A	1
4005	RW	1...10000	Current transformer ratio	1
4006	RW	1...4000	Voltage transformer ratio	1
4007	RW	0...2	Averaging time of the active power P Demand reactive power S Demand current I Demand 0 – 15, 1- 30, 2- 60 minutes	0
4008	RW	0,1	Synchronization with real-time clock 0 - no synchronization 1 - synchronization with a clock	1
4009	RW		reserved	
4010	RW	0...4	Energy counters erasing 0 – no changes, 1 – erase active energies 2 – erase reactive energies, 3 – erase apparent energies, 4 – erase all energies	0

4011	RW	0,1	Erasing averaged parameters P Demand, S Demand, I Demand	0
4012	RW	0,1	Min, max erasing	0
4013	RW	0,1	Erasing alarm signalization latch	0
4014	RW	0,1..43	Alarm output 1 - output value (code as in Table 6)	38
4015	RW	0..9	Alarm output 1 - type 0 – n_on, 1 – noFF, 2 – on, 3 – oFF, 4 – H_on, 5 – HoFF, 6 – 3non, 7 – 3noF, 8 – 3_on, 9 – 3_oF	0
4016	RW	-1440.. 0..1440 [$^{\circ}/_{oo}$]	Alarm output 1 - lower value of the alarm switch of the rated input range	900
4017	RW	-1440.. 0..1440 [$^{\circ}/_{oo}$]	Alarm output 1 - upper value of the alarm switch of the rated input range	1100
4018	RW	0..3600 s	Alarm output 1 - activation delay	0
4019	RW	0..3600 s	Alarm output 1 - alarm deactivation delay	0
4020	RW	0..3600 s	Alarm output 1 - re-activation lock	0
4021	RW	0,1	Alarm 1 signalization latch	0
4022	RW	0,1..43	Alarm output 2 - output value (code as in Table 6)	28
4023	RW	0..9	Alarm output 2 - type: 0 – n_on, 1 – noFF, 2 – on, 3 – oFF, 4 – H_on, 5 – HoFF, 6 – 3non, 7 – 3noF, 8 – 3_on, 9 – 3_oF	0
4024	RW	-1440..0.. 1440 [$^{\circ}/_{oo}$]	Alarm output 2 - lower value of the alarm switch of the rated input range	900
4025	RW	-1440..0.. 1440 [$^{\circ}/_{oo}$]	Alarm output 2 - upper value of the alarm switch of the rated input range	1100
4026	RW	0..3600 s	Alarm output 2 - activation delay	0
4027	RW	0..3600 s	Alarm output 2 - alarm deactivation delay	0
4028	RW	0..3600 s	Alarm output 2 - re-activation lock	0
4029	RW	0,1	Alarm 2 signalization latch	0
4030	RW	0,1..43	Alarm output 3 - output value (code as in Table 6)	29

4031	RW	0..9	Alarm output 3 - type: 0 – n_on, 1 – noFF, 2 – on, 3 – oFF, 4 – H_on, 5 – HoFF, 6 – 3non, 7 – 3noF, 8 – 3_on, 9 – 3_oF	0
4032	RW	-1440..0.. 1440 [%_oo]	Alarm output 3 - lower value of the alarm switch of the rated input range	900
4033	RW	-1440..0.. 1440 [%_oo]	Alarm output 3 - upper value of the alarm switch of the rated input range	1100
4034	RW	0..3600 s	Alarm output 3 - activation delay	0
4035	RW	0..3600 s	Alarm output 3 - alarm deactivation delay	0
4036	RW	0..3600 s	Alarm output 3 - re-activation lock	0
4037	RW	0,1	Alarm 3 signalization latch	0
4038	RW	0,1..43	Continuous output 1 - output value (code as in Tab. 6)	38
4039	RW	0..2	Continuous output 1 - type: 0 – (0..20) mA; 1 – (4...20) mA; 2 – (-20 ..20) mA	0
4040	RW	-1440..0.. 1440 [%_oo]	Continuous output 1 - lower value of the input range in [%_oo] of the rated input range	0
4041	RW	-1440..0.. 1440 [%_oo]	Continuous output 1 - upper value of the input range in [%_oo] of the rated input range	1000
4042	RW	-2400..0.. 2400	Continuous output 1 - lower value of the current output range (1 = 10uA)	0
4043	RW	1..2400	Continuous output 1 - upper value of the current output range (1 = 10uA)	2000
4044	RW	0..2	Continuous output 1 - manual switching on 0 – normal work, 1 – value set from the register 4042, 2 – value set from the register 4043	0
4045	RW	0,1..43	Continuous output 2 - output value (code as in Tab. 6)	28
4046	RW	0..2	Continuous output 2 - type: 0 – (0...20) mA; 1 – (4...20) mA; 2 – (-20 ..20) mA	0

4047	RW	-1440..0.. 1440 [°/°]	Continuous output 2 - lower value of the input range in [°/°] of the rated input range	0
4048	RW	-1440..0.. 1440 [°/°]	Continuous output 2 - upper value of the input range in [°/°] of the rated input range	1000
4049	RW	-2400..0.. 2400	Continuous output 2 - lower value of the current output range (1 = 10uA)	0
4050	RW	1..2400	Continuous output 2 - upper value of the current output range (1 = 10uA)	2000
4051	RW	0..2	Continuous output 2 - manual switching on 0 – normal work, 1 – value set from the register 4049, 2 – value set from the register 4050	0
4052	RW	0,1..43	Continuous output 3 - output value /code as in Tab. 6/	29
4053	RW	0..2	Continuous output 3 - type: 0 – (0...20) mA; 1 – (4...20) mA; 2 – (-20 ..20) mA	0
4054	RW	-1440..0.. 1440 [°/°]	Continuous output 3 - lower value of the input range in [°/°] of the rated input range	0
4055	RW	-1440..0.. 1440 [°/°]	Continuous output 3 - upper value of the input range in [°/°] of the rated input range	1000
4056	RW	-2400..0.. .2400	Continuous output 3 - lower value of the current output range (1 = 10uA)	0
4057	RW	1..2400	Continuous output 3 - upper value of the current output range (1 = 10uA)	2000
4058	RW	0..2	Continuous output 3 - manual switching on 0 – normal work, 1 – value set from the register 4056, 2 – value set from the register 4057	0
4059	RW	1..247	Modbus Network Address	1
4060	RW	0..3	Transmission mode: 0->8n2, 1->8e1, 2->8o1, 3->8n1	0

4061	RW	0..5	Baud rate: 0->4800, 1->9600 2->19200, 3->38400, 4->57600, 5->115200	1
4062	RW	0,1	Upgrade change of transmission parameters	0
4063	RW	0...9999	Constant of pulse output [pulses/kWh]	1000
4064	RW	0...9999	Constant of external energy counter [pulses/kWh]	1000
4065	RW	0..59	Seconds	0
4066	RW	0...2359	Hour *100 + minutes	0
4067	RW	101...1231	Month * 100 + day	101
4068	RW	2014...2100	Year	2014
4069	RW		reserved	0
4070	RW	0...0xFFFF	Archived values bit0 – reserved, bit1- U , bit2- I , ..., bit15- PF , acc. Table 6	0x0000
4071	RW	0...0xFFFF	Archived values bit16- L , bit17- H , ..., bit31- S , acc. Table 6	0x0000
4072	RW	0...0xFFFF	Archived values bit32 - PF , bit33- L , ..., bit43- I , acc. Table 6	0x0000
4073	RW	0...43	Value triggering archiving	0x0000
4074	RW	0..9	Archiving types: 0 – n_on, 1 – noFF, 2 – on, 3 – oFF, 4 – H_on, 5 – HoFF, 6 – 3non, 7 – 3noF, 8 – 3_on, 9 – 3_oF	0
4075	RW	-1440..0..1440	Archiving lower limit in ‰	900
4076	RW	-1440..0..1440	Archiving upper limit in ‰	1100
4077	RW	1 .. 3600	Archiving period in seconds	1
4078	RW	0,1	Deleting an internal archive	0
4079	RW	0,1	Copying archive to SD card „1”– copy archive to SD card	0
4080	RW		reserved	0

4081	RW	0...65535	The third and the second byte (B3.B2) of the IP address of the meter, the IPv4 address format: B3.B2.B1.B0	49320 (0xC0A8 = 192.168)
4082	RW	0...65535	The first and zero byte (B1.B0) of the IP address of the meter, the IPv4 address format: B3.B2.B1.B0	356 (0x0164 = 1.100)
4083	RW	0...65535	Trzeci i drugi bajt (B3.B2) maski podsiéci miernika, format maski: B3.B2.B1.B0	65535
4084	RW	0...65535	The third and the second byte (B3.B2) of the subnet mask of the meter, the mask format: B3.B2.B1.B0	65280
4085	R	0...65535	The fifth and fourth byte (B5.B4) of MAC address of the meter, format B5:B4:B3:B2:B1:B0	-
4086	R	0...65535	The third and the second byte (B3.B2) of MAC address of the meter, format B5:B4:B3:B2:B1:B0	-
4087	R	0...65535	The fifth and fourth byte (B1.B0) of MAC address of the meter, format B5:B4:B3:B2:B1:B0	-
4088	RW	0...65535	The third and the second byte (B3.B2) of the default gateway of the meter, the gateway address format: B3.B2.B1.B0	49320
4089	RW	0...65535	The first and zero byte (B1.B0) of the default gateway of the meter, the gateway address format: B3.B2.B1.B0	257

4090	RW	0,1	<p>Enabling / disabling the DHCP Client (supports automatic obtaining of IP protocol parameters of the meter's Ethernet interface from external DHCP servers in the same LAN)</p> <p>0 - DHCP disabled - you should manually configure the IP address and subnet mask of the meter;</p> <p>1 - DHCP enabled, the meter will automatically receive the IP address, subnet mask, and gateway address from the DHCP server when switching the supply on or selecting APPL option from the menu or entering the value „1” to the register 4099. The gateway address is the address of the server that assigned the parameters to the meter;</p>	1
4091	RW	0 .. 2	<p>Baud rate of the Ethernet interface:</p> <p>0 – automatic selection of the baud rate</p> <p>1 – 10 Mb/s</p> <p>2 – 100 Mb/s</p>	0
4092	RW	20...65535	FTP server commands port number	21
4093	RW	20...65535	FTP server data port number	1025
4094	RW	1...4	The maximum simultaneous connections to Modbus TCP/IP service	4
4095	RW	10...600	Port closing time of Modbus TCP/IP service, in seconds	60
4096	RW	0...255	Device address for Modbus TCP/IP protocol	1
4097	RW	0...65535	Modbus TCP port number	502
4098	RW	80...65535	Web server port number	80
4099	RW	0,1	<p>Saving the new parameters and initiate Ethernet interface</p> <p>0 – no changes</p> <p>1 - saving the new parameters and initiate the Ethernet interface</p>	0
4100	RW		reserved	0
4101	RW		reserved	0

4102	RW	0,1	Saving standard parameters (complete with resetting energy as well as min, max and mean power to 0)	0
4103	RW		reserved	0
4104	R	0..152	Active import energy, two older bytes	0
4105	R	0..65535	Active import energy, two younger bytes	0
4106	R	0..152	Active export energy, two older bytes	0
4107	R	0..65535	Active export energy, two younger bytes	0
4108	R	0..152	Reactive inductive energy, two older bytes	0
4109	R	0..65535	Reactive inductive energy, two younger bytes	0
4110	R	0..152	Reactive capacity energy, two older bytes	0
4111	R	0..65535	Reactive capacity energy, two younger bytes	0
4112	R	0..152	Apparent energy, two older bytes	0
4113	R	0..65535	Apparent energy, two younger bytes	0
4114	R	0..152	Active energy from external counter, two older bytes	0
4115	R	0..65535	Active energy from external counter, two younger bytes	0
4116	R	0..65535	Status 1 Register – see description below	0
4117	R	0..65535	Status 2 Register – see description below	0
4118	R	0..65535	Status 3 Register – see description below	0
4119	R	0..65535	Status 4 Register – see description below	0
4120	R	0..65535	Serial number two older bytes	-
4121	R	0..65535	Serial number two younger bytes	-
4122	R	0..65535	Software version (*100)	-
4123	R	0..65535	Bootloader version x 100	-
4124	R	0..100	The amount of space used on the SD card in %	0

4125	R	0..1000	The amount of space used in internal memory in % x 10	0
4126	R	0..1000	The percentage of the copied file on the SD card x 10	0
4127	R	0..65535	Nominal voltage x10	577/ 2300/ 4000
4128	R	0..65535	Nominal current (1 A) x 100	100
4129	R	0..65535	Nominal current (5 A) x 100	500
4130	RW	0,1	Ratio calculation: 0 – from register 4005..4006 1 – from register 4131..4135	0
4131	RW	0..18	Primary voltage value, two older bytes	0
4132	RW	0..65535	Primary voltage value, two younger bytes	100
4133	RW	1 .. 10000	Secondary current value x 10	1000
4134	RW	1 .. 20000	Primary current value	5
4135	RW	1 .. 1000	Secondary current value	5
....	RW	0..65535	reserved	0
4140	RW	0..65535	Working time in minutes (dwa starsze bajty)	0
4141	RW	0..65535	Working time in minutes (two younger bytes)	0
...	R	0..65535	reserved	0
4146	R	0..65535	Alarm 1 relay switching counter (two older bytes)	0
4147	R	0..65535	Alarm 1 relay switching counter (two younger bytes)	0
4148	R	0..65535	Alarm 2 relay switching counter (two older bytes)	0
4149	R	0..65535	Alarm 2 relay switching counter (two younger bytes)	0

4150	R	0..65535	Alarm 3 relay switching counter (two older bytes)	0
4151	R	0..65535	Alarm 3 relay switching counter (two younger bytes)	0

The alarm switching values stored in the registers 4016, 4017, 4024, 4025, 4032, 4033 are multiplied by 10, e.g. the value of 100% should be entered as „1000”.

The lower and upper values of the input range of the continuous outputs stored in the registers 4040, 4041, 4047, 4048, 4054, 4055 are multiplied by 10, e.g. the value of 100% should be entered as „1000”.

The lower and upper values of the current outputs range stored in the registers 4042, 4043, 4049, 4050, 4056, 4057 are multiplied by 100, e.g. the value of 20 mA should be entered as „2000”.

Energy is made available in hundreds of watt-hours (var-hours) in double 16-bit register, and for this reason, you should divide them by 100 when calculating values of particular energy from registers, e.g.:

Active import energy = (reg. value 4104 x 65536 + reg. value 4105) / 100 [kWh]

Active export energy = (reg. value 4106 x 65536 + reg. value 4107) / 100 [kWh]

Reactive inductive energy = (reg. value 4108 x 65536 + reg. value 4109) / 100 [kVarh]

Reactive capacity energy = (reg. value 4110 x 65536 + reg. value 4111) / 100 [kVarh]

Apparent energy = (reg. value 4112 x 65536 + reg. value 4113) / 100 [kVAh]

Active energy from external counter = (reg. value 4114 x 65536 + reg. value 4115) / 100 [kWh]

The voltage on the primary side = (reg. value 4131 x 65536 + reg. value 4132) [V]

Working time of N100 meter = (reg. value 4140 x 65536 + reg. value 4141) [minut]

Alarm 1 relay switching counter = (reg. value 4146 x 65536 + reg. value 4147)

Alarm 2 relay switching counter = (reg. value 4148 x 65536 + reg. value 4149)

Alarm 3 relay switching counter = (reg. value 4150 x 65536 + reg. value 4151)

Status 1 Register of a device (address 4116, R):

Bit 15 – „1” – non-volatile memory damage	Bit 7 – „1” – present continuous outputs 2, 3		
Bit 14 – „1” – no calibration of the input	Bit 6 – „1” – present continuous output 1		
Bit 13 – „1” – no calibration of the output			
Bit 12 – „1” – parameters value error			
Bit 11 – „1” – energy value error			
Bit 10 – „1” – phase sequence error	Bit 5 – „1” – present alarm output 3		
Bit 9	Bit 8	voltage range	Bit 4 – „1” – present alarm outputs 1, 2
0	0	57,7 V~	Bit 3 – „1” – present pulse input and output
0	1	230 V~	Bit 2 – „1” – present Ethernet and internal memory,
1	0	400 V~	Bit 1 – „1” – used battery of RTC
1	1	reserved	Bit 0 – reserved

Status 2 Register – (address 4117, R):

Bit 15 - „1” - alarm 3 in phase L3 (only the modes 3non, 3nof, 3_on, 3_of)

Bit 14 - „1” - alarm 3 in phase L2 (only the modes 3non, 3nof, 3_on, 3_of)

Bit 13 - „1” - alarm 3 in phase L3 (only the modes 3non, 3nof, 3_on, 3_of)

Bit 12 - „1” - alarm 2 in phase L3 (only the modes 3non, 3nof, 3_on, 3_of)

Bit 11 - „1” - alarm 2 in phase L2 (only the modes 3non, 3nof, 3_on, 3_of)

Bit 10 - „1” - alarm 2 in phase L1 (only the modes 3non, 3nof, 3_on, 3_of)

Bit 9 - „1” - alarm 1 in phase L3 (only the modes 3non, 3nof, 3_on, 3_of)

Bit 8 - „1” - alarm in phase L2 (only the modes 3non, 3nof, 3_on, 3_of)

Bit 7 - „1” - 1 in phase L1 (only the modes 3non, 3nof, 3_on, 3_of)

Bit 6 - „1” – alarm 3 signalization

Bit 5 - „1” – alarm 2 signalization

Bit 4 - „1” – alarm 1 signalization

Bit 3 – reserved

Bit 2 - „1” – alarm 3 activated

Bit 1 - „1” – alarm 2 activated

Bit 0 - „1” – alarm 1 activated

Status 3 Register – (address 4118, R): Status of the SD/SDHC card or the internal memory file system

Bit 15 - reversed direction of the current in phase L3

Bit 14 - reversed direction of the current in phase L2

Bit 13 - reversed direction of the current in phase L1

Bits 12 ... 5 – reserved

Bit 4 – archive dump to the card – *SD LED flashes green*

Bit 3 – the card is full – *SD LED lights up red*

Bit 2 – the card is 70% full – *SD LED lights up red*

Bit 1 – card installed successfully – *SD LED lights up green*

Bit 0 – file system error – *SD LED flashes red*

Status 4 Register – (address 4119, R) reactive power characteristics:

Bit 15 – measurement with phase L3 synchronization

Bit 14 – measurement with phase L2 synchronization

Bit 13 – measurement with phase L1 synchronization

Bit 12 – reserved

Bit 11 - „1” – capacity 3L max.

Bit 10 - „1” – capacity 3L min.

Bit 9 - „1” – capacity 3L

Bit 8 - „1” – capacity L3 max.

Bit 7 - „1” – capacity L3 min.

Bit 6 - „1” – capacity L3

Bit 5 - „1” – capacity L2 max.

Bit 4 - „1” – capacity L2 min.

Bit 3 - „1” – capacity L2

Bit 2 - „1” – capacity L1 max.

Bit 1 - „1” – capacity L1 min.

Bit 0 - „1” – capacity L1

Table 15

Register address	Operations	Range	Description	Default
4300	RW	1...10	Display luminosity: 1 – min., 10 – max.	8
4301	RW	0,1	Color of the display 0 – red, 1 - green	0
4302	RW		reserved	0
4303	RW	0x0001...0xFFFF	Enabling page display Bit0 – page 1, Bit1 – page 2, ...Bit15 – page 16	0x03FF
4304	RW	0...0x000F	Enabling page display Bit0 – page 17 Bit3 – page 20	0x0000
4305	RW	00..33, 35..38, 42..51	Page 1 display 1	1
4306	RW	00..33, 35..38, 42..51	Page 1 display 2	10
4307	RW	00..33, 35..38, 42..51	Page 1 display 3	19
4308	RW	00..51	Page 1 display 4	34
4309	RW	00..33, 35..38, 42..51	Page 2 display 1	35
4310	RW	00..33, 35..38, 42..51	Page 2 display 2	36
4311	RW	00..33, 35..38, 42..51	Page 2 display 3	37
4312	RW	00..51	Page 2 display 4	38
4313	RW	00..33, 35..38, 42..51	Page 3 display 1	2
4314	RW	00..33, 35..38, 42..51	Page 3 display 2	11
4315	RW	00..33, 35..38, 42..51	Page 3 display 3	20
4316	RW	00..51	Page 3 display 4	28
4317	RW	00..33, 35..38, 42..51	Page 4 display 1	3
4318	RW	00..33, 35..38, 42..51	Page 4 display 2	12
4319	RW	00..33, 35..38, 42..51	Page 4 display 3	21

4320	RW	00..51	Page 4 display 4	29
4321	RW	00..33, 35..38, 42..51	Page 5 display 1	6
4322	RW	00..33, 35..38, 42..51	Page 5 display 2	15
4323	RW	00..33, 35..38, 42..51	Page 5 display 3	24
4324	RW	00..51	Page 5 display 4	32
4325	RW	00..33, 35..38, 42..51	Page 6 display 1	29
4326	RW	00..33, 35..38, 42..51	Page 6 display 2	30
4327	RW	00..33, 35..38, 42..51	Page 6 display 3	31
4328	RW	00..51	Page 6 display 4	33
4329	RW	00..33, 35..38, 42..51	Page 7 display 1	42
4330	RW	00..33, 35..38, 42..51	Page 7 display 2	44
4331	RW	00..33, 35..38, 42..51	Page 7 display 3	46
4332	RW	00..51	Page 7 display 4	39
4333	RW	00..33, 35..38, 42..51	Page 8 display 1	8
4334	RW	00..33, 35..38, 42..51	Page 8 display 2	17
4335	RW	00..33, 35..38, 42..51	Page 8 display 3	26
4336	RW	00..51	Page 8 display 4	40
4337	RW	00..33, 35..38, 42..51	Page 9 display 1	9
4338	RW	00..33, 35..38, 42..51	Page 9 display 2	18
4339	RW	00..33, 35..38, 42..51	Page 9 display 3	27
4340	RW	00..51	Page 9 display 4	41
4341	RW	00..33, 35..38, 42..51	Page 10 display 1	48
4342	RW	00..33, 35..38, 42..51	Page 10 display 2	49
4343	RW	00..33, 35..38, 42..51	Page 10 display 3	50
4344	RW	00..51	Page 10 display 4	51
4345	RW	00..33, 35..38, 42..51	Page 11 display 1	0
4346	RW	00..33, 35..38, 42..51	Page 11 display 2	0

4347	RW	00..33, 35..38, 42..51	Page 11 display 3	0
4348	RW	00..51	Page 11 display 4	0
4349	RW	00..33, 35..38, 42..51	Page 12 display 1	0
4350	RW	00..33, 35..38, 42..51	Page 12 display 2	0
4351	RW	00..33, 35..38, 42..51	Page 12 display 3	0
4352	RW	00..51	Page 12 display 4	0
4353	RW	00..33, 35..38, 42..51	Page 13 display 1	0
4354	RW	00..33, 35..38, 42..51	Page 13 display 2	0
4355	RW	00..33, 35..38, 42..51	Page 13 display 3	0
4356	RW	00..51	Page 13 display 4	0
4357	RW	00..33, 35..38, 42..51	Page 14 display 1	0
4358	RW	00..33, 35..38, 42..51	Page 14 display 2	0
4359	RW	00..33, 35..38, 42..51	Page 14 display 3	0
4360	RW	00..51	Page 14 display 4	0
4361	RW	00..33, 35..38, 42..51	Page 15 display 1	0
4362	RW	00..33, 35..38, 42..51	Page 15 display 2	0
4363	RW	00..33, 35..38, 42..51	Page 15 display 3	0
4364	RW	00..51	Page 15 display 4	0
4365	RW	00..33, 35..38, 42..51	Page 16 display 1	0
4366	RW	00..33, 35..38, 42..51	Page 16 display 2	0
4367	RW	00..33, 35..38, 42..51	Page 16 display 3	0
4368	RW	00..51	Page 16 display 4	0
4369	RW	00..33, 35..38, 42..51	Page 17 display 1	0
4370	RW	00..33, 35..38, 42..51	Page 17 display 2	0
4371	RW	00..33, 35..38, 42..51	Page 17 display 3	0
4372	RW	00..51	Page 17 display 4	0
4373	RW	00..33, 35..38, 42..51	Page 18 display 1	0

4374	RW	00..33, 35..38, 42..51	Page 18 display 2	0
4375	RW	00..33, 35..38, 42..51	Page 18 display 3	0
4376	RW	00..51	Page 18 display 4	0
4377	RW	00..33, 35..38, 42..51	Page 19 display 1	0
4378	RW	00..33, 35..38, 42..51	Page 19 display 2	0
4379	RW	00..33, 35..38, 42..51	Page 19 display 3	0
4380	RW	00..51	Page 19 display 4	0
4381	RW	00..33, 35..38, 42..51	Page 20 display 1	0
4382	RW	00..33, 35..38, 42..51	Page 20 display 2	0
4383	RW	00..33, 35..38, 42..51	Page 20 display 3	0
4384	RW	00..51	Page 20 display 4	0
4385	RW	0;1	Restore manufacturer's pages	0

Table 16

16-bit register address	Register address 32-bit	Operations	Description	Unit	3Ph/ 4W	3Ph/ 3W
6000/7000	7500	R	L1 phase voltage	V	√	x
6002/7002	7501	R	L1 phase current	A	√	√
6004/7004	7502	R	L1 phase active power	W	√	x
6006/7006	7503	R	L1 phase reactive power	VAr	√	x
6008/7008	7504	R	L1 phase apparent power	VA	√	x

6010/7010	7505	R	L1 phase active power factor (PF1=P1/S1)	-	√	x
6012/7012	7506	R	tgφ factor of L1 phase (tg1 =Q1/P1)	-	√	x
6014/7014	7507	R	THD U1	%	√	x
6016/7016	7508	R	THD I1	%	√	x
6018/7018	7509	R	L2 phase voltage	V	√	x
6020/7020	7510	R	L2 phase current	A	√	√
6022/7022	7511	R	L2 phase active power	W	√	x
6024/7024	7512	R	L2 phase reactive power	VAr	√	x
6026/7026	7513	R	L2 phase apparent power	VA	√	x
6028/7028	7514	R	L2 phase active power factor (PF2=P2/S2))	-	√	x
6030/7030	7515	R	tgφ factor of L2 phase (tg2 =Q2/P2)	-	√	x
6032/7032	7516	R	THD U2	%	√	x
6034/7034	7517	R	THD I2	%	√	x
6036/7036	7518	R	L3 phase voltage	V	√	x
6038/7038	7519	R	L3 phase current	A	√	√
6040/7040	7520	R	L3 phase active power	W	√	x
6042/7042	7521	R	L3 phase reactive power	VAr	√	x
6044/7044	7522	R	L3 phase apparent power	VA	√	x
6046/7046	7523	R	L3 phase active power factor (PF3=P3/S3)	-	√	x
6048/7048	7524	R	tgφ factor of L3 phase (tg3 =Q3/P3)	-	√	x
6050/7050	7525	R	THD U3	%	√	x

6052/7052	7526	R	THD I3	%	√	x
6054/7054	7527	R	Mean 3-phase voltage	V	√	x
6056/7056	7528	R	Mean 3-phase current	A	√	√
6058/7058	7529	R	3-phase active power (P1+P2+P3)	W	√	√
6060/7060	7530	R	3-phase reactive power (Q1+Q2+Q3)	VA _r	√	√
6062/7062	7531	R	3-phase apparent power (S1+S2+S3)	VA	√	√
6064/7064	7532	R	3-phase active power factor (PF=P/S)	-	√	√
6066/7066	7533	R	mean tgφ factor for 3 phases (tg=Q/P)	-	√	√
6068/7068	7534	R	THD U mean 3-phase	%	√	x
6070/7070	7535	R	THD I mean 3-phase	%	√	x
6072/7072	7536	R	Frequency	F	√	√
6074/7074	7537	R	Phase-to-phase voltage L1-2	V	√	√
6076/7076	7538	R	Phase-to-phase voltage L2-3	V	√	√
6078/7078	7539	R	Phase-to-phase voltage L3-1	V	√	√
6080/7080	7540	R	Mean phase-to-phase voltage	V	√	√
6082/7082	7541	R	Active power averaged (P Demand)	W	√	√
6084/7084	7542	R	Apparent power averaged (S Demand)	VA	√	√
6086/7086	7543	R	Current averaged (I Demand)	A	√	√
6088/7088	7544	R	Neutral wire current (calculated from vectors)	A	√	x

6090/7090	7545	R	Active 3-phase import energy (no. of register 7546 overflows, resets to 0 after reaching 9999.9 MWh)	100 MWh	√	√
6092/7092	7546	R	Active 3-phase import energy (counter counting up to 99999.99 kWh)	kWh	√	√
6094/7094	7547	R	Active 3-phase export energy (no. of register 7548 overflows, resets to 0 after reaching 9999.9 MWh)	100 MWh	√	√
6096/7096	7548	R	Active 3-phase export energy (counter counting up to 99999.99 kWh)	kWh	√	√
6098/7098	7549	R	Reactive 3-phase inductive energy (no. of register 7550 overflows, resets to 0 after reaching 9999.9 MVAh).	100 MVAh	√	√
6100/7100	7550	R	Reactive 3-phase inductive energy (counter counting up to 99999.99 kVAh)	kVAh	√	√
6102/7102	7551	R	Reactive 3-phase capacity energy (no. of register 7552 overflows, resets to 0 after reaching 9999.9 MVAh)	100 MVAh	√	√
6104/7104	7552	R	Reactive 3-phase capacity energy (counter counting up to 99999.99 kVAh)	kVAh	√	√
6106/7106	7553	R	Apparent energy (no. of register 7554 overflows, resets to 0 after reaching 9999.9 MVAh)	100 MVAh	√	√
6108/7108	7554	R	Apparent energy (counter counting up to 9999.99 kVAh)	kVAh	√	√
6110/7110	7555	R	Active 3-phase external energy (no. of register 7555 overflows, resets to 0 after reaching 9999,9 MWh)	100 MWh	√	√

6112/7112	7556	R	Active 3-phase external energy (counter counting up to 99999,99 kWh)	kWh	√	√
6114/7114	7557	R	Time – seconds	sek	√	√
6116/7116	7558	R	Time – hours, minutes	-	√	√
6118/7118	7559	R	Date – month, day	-	√	√
6120/7120	7560	R	Year – 2014 - 2100	-	√	√
6122/7122	7561	R	Actuated continuous output 1	mA	√	√
6124/7124	7562	R	Actuated continuous output 2	mA	√	√
6126/7126	7563	R	Actuated continuous output 3	mA	√	√
6128/7128	7564	R	Status 1 register	-	√	√
6130/7130	7565	R	Status 2 register	-	√	√
6132/7132	7566	R	Status 3 register	-	√	√
6134/7134	7567	R	Status 4 register	-	√	√
6136/7136	7568	R	Voltage L1 min	V	√	x
6138/7138	7569	R	Voltage L1 max	V	√	x
6140/7140	7570	R	Voltage L2 min	V	√	x
6142/7142	7571	R	Voltage L2 max	V	√	x
6144/7144	7572	R	Voltage L3 min	V	√	x
6146/7146	7573	R	Voltage L3 max	V	√	x
6148/7148	7574	R	Current L1 min	A	√	√
6150/7150	7575	R	Current L1 max	A	√	√
6152/7152	7576	R	Current L2 min	A	√	√

6154/7154	7577	R	Current L2 max	A	√	√
6156/7156	7578	R	Current L3 min	A	√	√
6158/7158	7579	R	Current L3 max	A	√	√
6160/7160	7580	R	Active power L1 min	W	√	x
6162/7162	7581	R	Active power L1 max	W	√	x
6164/7164	7582	R	Active power L2 min	W	√	x
6166/7166	7583	R	Active power L2 max	W	√	x
6168/7168	7584	R	Active power L3 min	W	√	x
6170/7170	7585	R	Active power L3 max	W	√	x
6172/7172	7586	R	Reactive power L1 min	Var	√	x
6174/7174	7587	R	Reactive power L1 max	Var	√	x
6176/7176	7588	R	Reactive power L2 min	Var	√	x
6178/7178	7589	R	Reactive power L2 max	Var	√	x
6180/7180	7590	R	Reactive power L3 min	Var	√	x
6182/7182	7591	R	Reactive power L3 max	Var	√	x
6184/7184	7592	R	Apparent power L1 min	VA	√	x
6186/7186	7593	R	Apparent power L1 max	VA	√	x
6188/7188	7594	R	Apparent power L2 min	VA	√	x
6190/7190	7595	R	Apparent power L2 max	VA	√	x
6192/7192	7596	R	Apparent power L3 min	VA	√	x
6194/7194	7597	R	Apparent power L3 max	VA	√	x
6196/7196	7598	R	Power factor (PF) L1 min	-	√	x
6198/7198	7599	R	Power factor (PF) L1 max	-	√	x
6200/7200	7600	R	Power factor (PF) L2 min	-	√	x

6202/7202	7601	R	Power factor (PF) L2 max	-	√	x
6204/7204	7602	R	Power factor (PF) L3 min	-	√	x
6206/7206	7603	R	Power factor (PF) L3 max	-	√	x
6208/7208	7604	R	Reactive to active power ratio L1 min	-	√	x
6210/7210	7605	R	Reactive to active power ratio L1 max	-	√	x
6212/7212	7606	R	Reactive to active power ratio L2 min	-	√	x
6214/7214	7607	R	Reactive to active power ratio L2 max	-	√	x
6216/7216	7608	R	Reactive to active power ratio L3 min	-	√	x
6218/7218	7609	R	Reactive to active power ratio L3 max	-	√	x
6220/7220	7610	R	Phase-to-phase voltage L1-2 min	V	√	√
6222/7222	7611	R	Phase-to-phase voltage L1-2 max	V	√	√
6224/7224	7612	R	Phase-to-phase voltage L2-3 min	V	√	√
6226/7226	7613	R	Phase-to-phase voltage L2-3 max	V	√	√
6228/7228	7614	R	Phase-to-phase voltage L3-1 min	V	√	√
6230/7230	7615	R	Phase-to-phase voltage L3-1 max	V	√	√
6232/7232	7616	R	Mean 3-phase voltage min	V	√	x
6234/7234	7617	R	Mean 3-phase voltage max	V	√	x
6236/7236	7618	R	Mean 3-phase current (min)	A	√	√
6238/7238	7619	R	Mean 3-phase current (max)	A	√	√

6240/7240	7620	R	3-phase active power min	W	√	√
6242/7242	7621	R	3-phase active power max	W	√	√
6244/7244	7622	R	3-phase reactive power min	var	√	√
6246/7246	7623	R	3-phase reactive power max	var	√	√
6248/7248	7624	R	3-phase apparent power min	VA	√	√
6250/7250	7625	R	3-phase apparent power max	VA	√	√
6252/7252	7626	R	Power factor (PF) min	-	√	√
6254/7254	7627	R	Power factor (PF) max	-	√	√
6256/7256	7628	R	Reactive to active power ratio (3-phase mean min.)	-	√	√
6258/7258	7629	R	Reactive to active power ratio (3-phase mean max.)	-	√	√
6260/7260	7630	R	Frequency min	Hz	√	√
6262/7262	7631	R	Frequency max	Hz	√	√
6264/7264	7632	R	Mean phase-to-phase voltage min	V	√	√
6266/7266	7633	R	Mean phase-to-phase voltage max	V	√	√
6268/7268	7634	R	Active power averaged (P Demand) min	W	√	√
6270/7270	7635	R	Active power averaged (P Demand) max	W	√	√
6272/7272	7636	R	Apparent power averaged (S Demand) min	VA	√	√
6274/7274	7637	R	Apparent power averaged (S Demand) max	VA	√	√
6276/7276	7638	R	Current averaged (I Demand) min	A	√	√
6278/7278	7639	R	Current averaged (I Demand) max	A	√	√

6280/7280	7640	R	Neutral wire current min	A	√	x
6282/7282	7641	R	Neutral wire current max	A	√	x
6284/7284	7642	R	THD U1 min	%	√	x
6286/7286	7643	R	THD U1 max	%	√	x
6288/7288	7644	R	THD U2 min	%	√	x
6290/7290	7645	R	THD U2 max	%	√	x
6292/7292	7646	R	THD U3 min	%	√	x
6294/7294	7647	R	THD U3 max	%	√	x
6296/7296	7648	R	THD I1 min	%	√	x
6298/7298	7649	R	THD I1 max	%	√	x
6300/7300	7650	R	THD I2 min	%	√	x
6302/8002	7651	R	THD I2 max	%	√	x
6304/8004	7652	R	THD I3 min	%	√	x
6306/8006	7653	R	THD I3 max	%	√	x
6308/8008	7654	R	HarU1[2] 2nd harmonic of L1 phase voltage	%	√	x
6310/8010	7655	R	HarU1[3] 3rd harmonic of L1 phase voltage	%	√	x
:	:	R	:			
:	:	R	:			
6404/8104	7702	R	HarU1[50] 50th harmonic of L1 phase voltage	%	√	x
6406/8106	7703	R	HarU1[51] 51st harmonic of L1 phase voltage	%	√	x
6408/8108	7704	R	HarU2[2] 2nd harmonic of L2 phase voltage	%	√	x
6410/8110	7705	R	HarU2[3] 3rd harmonic of L2 phase voltage	%	√	x

:	:	R	:			
:	:	R	:			
6504/8204	7752	R	HarU2[50] 50th harmonic of L2 phase voltage	%	√	x
6506/8206	7753	R	HarU2[51] 51st harmonic of L2 phase voltage	%	√	x
6508/8208	7754	R	HarU3[2] 2nd harmonic of L3 phase voltage	%	√	x
6510/8210	7755	R	HarU3[3] 3rd harmonic of L3 phase voltage	%	√	x
:	:	R	:			
:	:	R	:			
6604/8304	7802	R	HarU3[50] 50th harmonic of L3 phase voltage	%	√	x
6606/8306	7803	R	HarU3[51] 51st harmonic of L3 phase voltage	%	√	x
6608/8308	7804	R	HarI1[2] 2nd harmonic of L1 phase current	%	√	x
6610/8310	7805	R	HarI1[3] 3rd harmonic of L1 phase current	%	√	x
:	:	R	:			
:	:	R	:			
6704/8398	7852	R	HarI1[50] 50th harmonic of L1 phase current	%	√	x
6706/8400	7853	R	HarI1[51] 51st harmonic of L1 phase current	%	√	x
6708/8408	7854	R	HarI2[2] 2nd harmonic of L2 phase current	%	√	x
6710/8410	7855	R	HarI2[3] 3rd harmonic of L2 phase current	%	√	x
:	:	R	:			
:	:	R	:			

6804/8504	7902	R	Har12[50] 50th harmonic of L2 phase current	%	√	x
6806/8506	7903	R	Har12[51] 51st harmonic of L2 phase current	%	√	x
6808/8508	7904	R	Har13[2] 2nd harmonic of L3 phase current	%	√	x
6810/8510	7905	R	Har13[3] 3rd harmonic of L3 phase current	%	√	x
:	:	R	:			
:	:	R	:			
6904/8604	7952	R	Har13[50] 50th harmonic of L3 phase current	%	√	x
6906/8606	7953	R	Har13[51] 51st harmonic of L3 phase current	%	√	x

In case of exceeding (measuring value is out of the measuring range) the value 1e20 is set.

9. SOFTWARE UPGRADE

A feature implemented in the N100 meters enables to upgrade firmware using a PC with eCon software installed. Free eCon software and the update files are available at www.ditel.es. Updating can be done via RS485 interface

a)

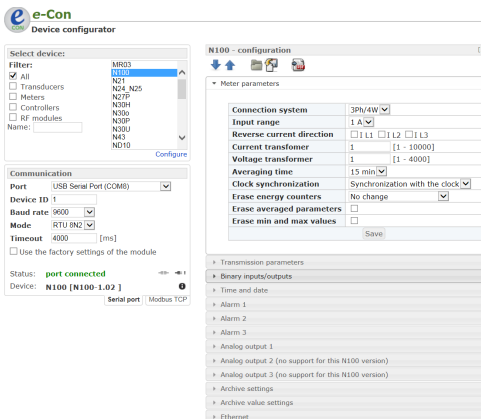

b)

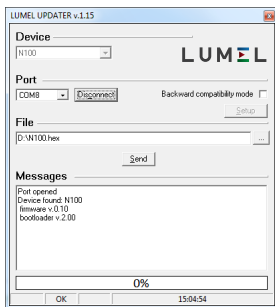



Fig. 20. Program window view: a) eCon, b) software upgrade

Caution! Software update automatically resets meter settings to manufacturer settings, so it is recommended to save meter settings using eCon software before upgrading.

After launching eCon software, set in the settings required serial port, baud rate, mode and address of the meter. Next, select the N100 meter and click *Config*. Click the down arrow icon to read all of the settings then the disk icon to save the settings to a file (required to restore the settings later). After selecting the option *Update firmware* (in the upper right corner of the screen) the window Lumel Updater (LU) will be opened (LU) – Fig. 20b. Click *Connect*. The *Messages* information window displays information concerning upgrade process. If the port is opened correctly, a *Port opened* message appears. Upgrade mode is enabled using either of the two methods: remotely via LU (using LPCon settings: address, mode, baud rate, COM port) and by turning a meter on while pressing the button  (while entering bootloader mode the button is used to set communication settings: baud rate 9600, RTU8N2, address 1). The display will show the bootloader version, while the LU program displays the message *Device found* and the name and version of the connected device. Click the „...” button and browse to the meter upgrade file. If the file is opened correctly, a *File opened* message is displayed. Press the *Send* button. When upgrade is successfully completed, the meter begins normal work while the information window displays *Done* message and upgrade elapsed time. After the LU window is closed, go to parameter group *Service parameters*, select *Set default meter settings* and press the button *Restore*. Then press the folder icon to open a previously saved settings file and press the up arrow icon to save the settings in the meter. Current software version can be checked by reading the welcome message when switching the meter on.

Caution! Turning meter supply off during upgrade process may result in permanent damage!

10. ERROR CODES

During the meter operation the error messages may be displayed. Following list shows reasons of errors.

- **Err bat** – displayed when the battery of the internal RTC clock is used up. The measurement is carried out after switching the supply on and every day at midnight. The message can be turned off by pressing the button . The disabled message remains inactive till the renewed switching of the meter on.

- **Err CAL, Err EE** – meter memory is damaged. In such case a meter should be sent back to the manufacturer.

- **Err PAR** – incorrect operational parameters of the meter. In such case a meter should be set to default settings (from menu or via RS-485 interface). The message can be turned off by pressing the button .

----- – upper overrun. Measuring value is out of the measuring range.

----- – lower overrun. Measuring value is out of the measuring range.

11. TECHNICAL DATA

Measuring ranges and permissible basic errors

Table 17

Measured value	Measuring range	L1	L2	L3	Σ	Class (*)/ basic error (*) class relative to the measured value acc. to EN61557-12;
Current 1/5 A 1 A~ 5 A~	0,010 ..0,100..1,200 A (tr_I=1) 0,050 ..0,500.. 6,000 A (tr_I=1) ...60,00 kA (tr_I≠1)	•	•	•		Class 0.2
Voltage L-N 57.7 V~ 230 V~ 400 V~	5,7..11,5 ..70,0 V (tr_U=1) 23,0..46,0 .. 276,0 V (tr_U=1) 40,0..80,0 .. 480,0 V (tr_U=1) ...1920,0 kV (tr_U≠1)	•	•	•		Class 0.2
Voltage L-L 100 V~ 400 V~ 690 V~	10,0 ..20,0..120,0 V (tr_U=1) 40,0..80,0 .. 480,0 V (tr_U=1) 69,0..138,0 .. 830,0 V (tr_U=1) ...1999,0 kV (tr_U≠1)	•	•	•		Class 0.5
Active power P _i , active power averaged P _{dt}	-19999 MW .. 0,000 W 19999 MW (tr_U≠1, tr_I≠1)	•	•	•	•	Class 0.5
Reactive power Q _i	-19999 MVar .. 0,000 Var 19999 MVar (tr_U≠1, tr_I≠1)	•	•	•	•	Class 2
Apparent power S _i , apparent power averaged S _{dt}	0,000 .. 1999,9 VA 19999 MVA (tr_U≠1, tr_I≠1)	•	•	•	•	Class 0.5
Active energy EnP / import or export /	-1999,9 MWh .. 0,00 kWh .. 19999 MWh (tr_U≠1, tr_I≠1)				•	Class 0.5
Reactive energy EnQ /capacity or inductive/	0,00 .. 1999,9 .. kVarh .. 19999 MVarh (tr_U≠1, tr_I≠1)				•	Class 2

Apparent energy EnS	0,00 ...1999,9 kWh19999 MVAh (tr_U≠1,tr_I≠1)					•	Class 0.5
Active power factor PF _i	<u>-1,000 .. 0,000 .. 1,000</u>	•	•	•	•		± 0.01 basic error
tg _i factor (reactive to active power ratio)	<u>-1,200 .. 0 .. 1,200</u>	•	•	•	•		± 0.01 basic error
Frequency F	<u>45.00 ..65.00</u> Hz					•	Class 0.2
Harmonic distortion factor of voltage THDU, current THDI	<u>0,000 .. 100,0</u> %	•	•	•	•		Class 5 50 / 60 Hz
Harmonic amplitudes of voltage U _{h1} ... U _{h50} , current I _{h1} ... I _{h50}	<u>0,0 .. 100,0</u> %	•	•	•	•		Class 5 50 / 60 Hz

tr_I – current transformer ratio: 1..10000,
tr_U – voltage transformer ratio: 1..4000;

Power consumption:

- in supply circuit ≤ 12 VA
- in voltage circuit ≤ 0.5 VA
- in current circuit ≤ 0.1 VA

Readout field

4 x 4½ - digits two-color LED display
(red, green), 14 mm

Relay outputs	<p>3 or 1 programmable relay depending on the version, volt-free NO contacts, load (resistive) 0.5 A /250 V a.c. or 5 A/30 V d.c. Switching number: mechanical min. 5×10^6 electric min. 1×10^5</p>
Analog outputs	<p>1 output: 0... 20mA (4...20mA) programmable or 3 outputs -20..0..20 mA programmable, depending on the version Load resistance $\leq 500 \Omega$ Voltage 10 V Basic error 0.2 %.</p>
Energy pulse output (for the versions 3 relay outputs, 1 analog)	<p>1 OC (NPN), passive Supply voltage 18..27 V precision as for active power</p>
Pulsing constant of OC output	<p>0..9999 pulses/kWh independently of set tr_U, tr_I ratios;</p>
Passive pulse input (for the versions 3 relay outputs, 1 analog)	<p>0/12..36V d.c.</p>
Serial interface RS485	<p>Modbus RTU 8N2,8E1,8O1,8N1 Address 1..247, Baud rate 4.8, 9.6, 19.2, 38.4, 57.6, 115.2 kbit/s maximum response time: 600 ms</p>
Ethernet	<p>10/100 Base-T, RJ45 socket, Server WWW. Server FTP. Server Modbus TCP/IP, DHCP client</p>

Sampling	A/C converter 16-bit 6.4 kHz sampling rate at 50 Hz 7.68 kHz at 60 Hz Simultaneous sampling of all channels, 128 samples per cycle
Harmonics	Harmonic (n) 1..51 Harmonic distortion factor referred to the voltage THD, current THD (n=2..51) 0.0 ..100.0 % FFT analysis (Fast Fourier Transform)
Real Time Clock	±20 ppm, real time clock battery CR2032
Registration	Archiving period (registration interval) 1..3600 sec. Registration activation modes: n_on, noFF, on,oFF, H_on, HoFF, 3non, 3noF, 3_on, 3_oF, Registration time: depends on the recording interval eg. for interval 1 sec. ca. 220 days SD internal memory: 8GB

Terminals

Cross section	0.05 .. 2.5 mm ²
Clamping screws	M3
Tightening torque	0.5 Nm

Protection grade ensured by the housing

from the front	IP 40
from terminals side	IP 20

Weight 0.8 kg

Overall dimensions 144 x 144 x 77 mm

Reference and rated operating conditions

- supply voltage Uaux 85..253 V a.c. (40...400) Hz or 90..300 V d.c.

- input signal: $0 \dots 0.1 \dots 1.2 I_n$; $0.1 \dots 0.2 \dots 1.2 U_n$
for current, voltage PFi ,tg_i
frequency 45 ..50 .. 60 .. 65 Hz;
sinusoidal (THD ≤ 8%)
- power factor -1...0...1
- ambient temperature -10..23..+55 °C, class K55
acc. to EN61557-12
- storage temperature -20..+70 °C
- humidity 0 .. 40 ..60 ..95 % (no condensation)
- max peak factor:
 - current 2
 - voltage 2
- external magnetic field ≤ 40...400 A/m d.c.
≤ 3 A/m a.c. 50/60 Hz
- short-term overload
 - voltage inputs 5 sec. 2 Un
 - current inputs 1 sec. 50 A
- working position any
- warm-up time 15 min.

Real time clock battery: CR2032

Additional errors:

in % of the base error

- from ambient temperature changes < 50 % / 10 °C
- for THD > 8% < 50 %

Standards fulfilled by the meter:

Electromagnetic compatibility:

- noise immunity acc. to EN 61000-6-2
- noise emission acc. to EN 61000-6-4

Safety requirements:

according to EN 61010-1 standard

- isolation between circuits: basic
- installation category III for voltage to earth up to 300 V
installation category II
for voltage to earth up to 600 V

- pollution grade 2,
- maximum phase-to-earth operating voltage:
 - for supply circuits and relay outputs 300 V
 - for measurement input 500 V
 - for circuits RS485, Ethernet, pulse input and output, analog outputs: 50 V
- altitude a.s.l. < 2000 m.

12. ORDERING CODE

N100 network parameters meter ordering code.

Table 18

Power network analyser N100 -	X	X	X	XX	X	X
Voltage input (phase/phase-to-phase) Un:						
3 x 57.7/100 V	1					
3 x 230/400 V	2					
3 x 400/690 V	3					
Outputs:						
3 x relay, 1 x analog, 1 x pulse input, 1 x pulse output		1				
3 x analog, 1 x relay		2				
Optional accessories:						
without Ethernet interface			0			
Ethernet interface, internal memory file system			1			
Version:						
standard				00		
custom-made*				XX		
Language version:						
Spanish					S	
English					E	
French					F	
Acceptance tests:						
without extra requirements						0
with quality inspection certificate						1
acc. to customer's request*						X

* - only after agreeing with a manufacturer

Note:

- in version outputs: 3 relays, 1 analog, 1 pulse input, 1 pulse output
- analog output range is 0 ..20 mA.
- in version outputs: 3 analog, 1 relay - analog outputs range is
-20..0..20 mA.

The analog outputs are programmable in both versions.

ORDERING CODE EXAMPLE:

the code **N100-2 1 1 1 00 E 1** – means:

N100 – N100 meter,

2 – input voltage 3 x 230/400 V,

1 – 3 relays, 1 programmable analog output 0..20 mA,
1 pulse input, 1 pulse output,

1 – with Ethernet interface and internal memory file system,

00 – standard version,

E – English language version,,

0 – without extra requirements.



MT-N100_EN_280617

DISEÑOS Y TECNOLOGIA S.A.

Xarol, 6B P.I. Les Guixeres
08915 Badalona - ESPAÑA
tel.: +34 933 394 758, fax +34 934 903 145
www.ditel.es

made in POLAND by:
LUMEL S.A.
www.lumel.com.pl

30722004B