

METER OF NETWORK PARAMETERS
ND20LITE



USER MANUAL



Contents

1. APPLICATION	5
2. METER SET	6
3. BASIC REQUIREMENTS AND OPERATIONAL SAFETY	6
4. INSTALLATION	7
5. METER DESCRIPTION	8
6. ND20 PROGRAMMING	12
7. UPDATING OF SOFTWARE.....	35
8. RS-485 INTERFACE.....	37
9. ERROR CODES	60
10. TECHNICAL DATA	62
11. VERSION CODES	66
12. MAINTENANCE AND GUARANTEE	68

1. APPLICATION

The ND20LITE meter is a digital programmable panel meter destined for the measurement of single-phase power network parameters (2-wire network) and 3-phase, 3,4-wire network in balanced and unbalanced systems with the simultaneous display of measured quantities on a LCD display. The meter enables the control and optimization of power electronics devices, systems and industrial installation operations.

The meter ensures the measurement of: rms values of voltage and current, active, reactive and apparent power, active, reactive energy, power factors, frequency, 15, 30, 60 minutes' mean active power, THD. Additionally, the current value in the neutral wire is calculated. Voltages and currents are multiplied by given voltage and current ratios of measuring transformers. Indications of power and energy take into consideration values of programmed ratios. The value of each measured quantity can be transmitted to the master system through the RS-485 interface. The relay output signals the overflow of the chosen quantity, and the pulse output can be used for the consumption check of 3-phase active and reactive energy.

The meter has a galvanic separation between respective blocks:

- supply,
- measuring inputs,
- voltage and current inputs,
- RS-485 output,
- impulse output.

2. METER SET

The set of the ND20LITE meter is composed of:

1. ND20LITE meter 1 pc.
2. user's manual 1 pc.
3. seal 1 pc.
4. holders to fix the meter in the panel... 4 pcs

3. BASIC REQUIREMENTS AND OPERATIONAL SAFETY



In the safety service scope, the ND20LITE meter meets to requirements of the EN 61010 -1 standard.

Observations Concerning the Operational Safety:

- All operations concerning transport, installation, and commissioning as well as maintenance, must be carried out by qualified, skilled personnel, and national regulations for the prevention of accidents must be observed.
- Before switching the meter on, one must check the correctness of connection to the network.
- Before removing the meter housing, one must switch the supply off and disconnect measuring circuits
- The removal of the meter housing during the guarantee contract period may cause its cancellation.
- The ND20LITE meter is destined to be installed and used in industrial electromagnetic environment conditions.
- One must remember that in the building installation, a switch or a circuit-breaker should be installed. This switch should be located near the device, easy accessible by the operator, and suitably marked.

4. INSTALLATION

The ND20LITE meter is adapted to be fixed on a panel by means of holders. The fitting way is presented on the fig.1.

Housing overall dimensions: 96 x 96 x 77 mm. At the rear side of the meter, there are screw terminal strips which enable the connection of external wires with a cross-section up to 2.5 mm².

One must prepare a 92.5^{+0.6} x 92.5^{+0.6} mm cut-out in the panel. The material thickness which the panel is made from should not exceed 15 mm. Insert the meter from the frontal panel side with the disconnected supply voltage. After the insertion into the hole, fix the meter by means of holders.

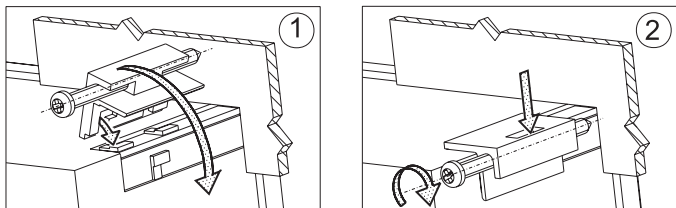

Fig. 1. Meter fitting

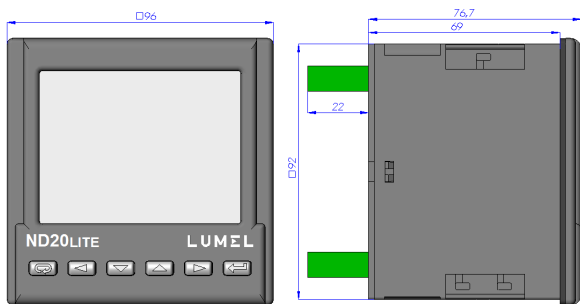
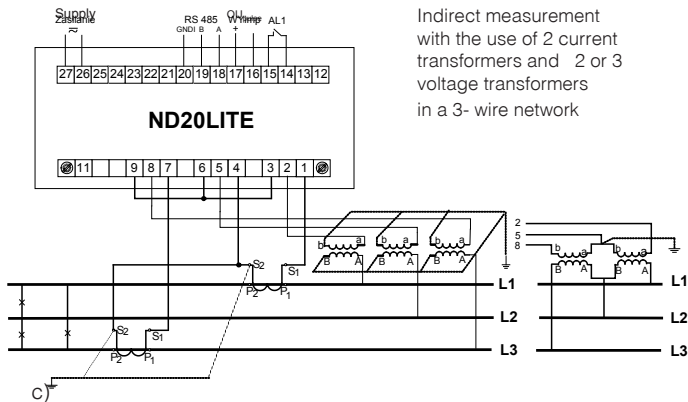
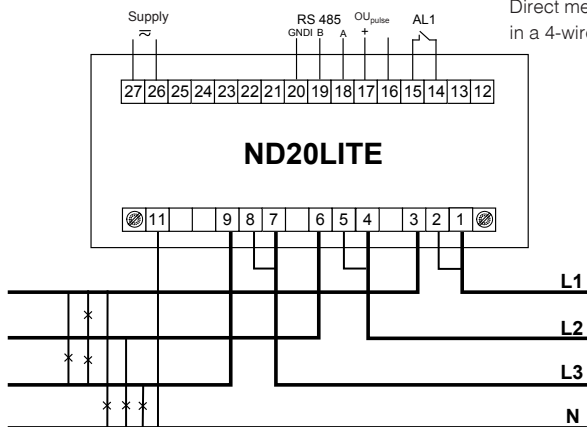

Fig. 2 Meter overall dimensions



Indirect measurement with the use of 2 current transformers and 2 or 3 voltage transformers in a 3- wire network



Direct measurement in a 4-wire network.

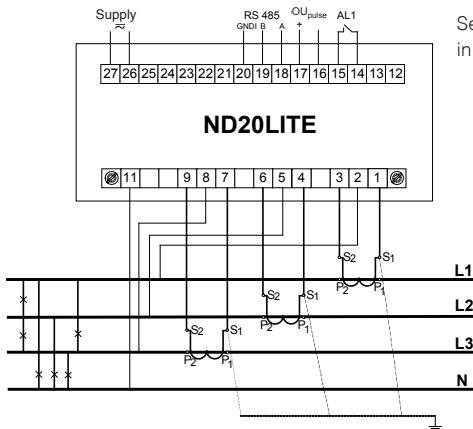

Semi-indirect measurement
in a 4-wire network.

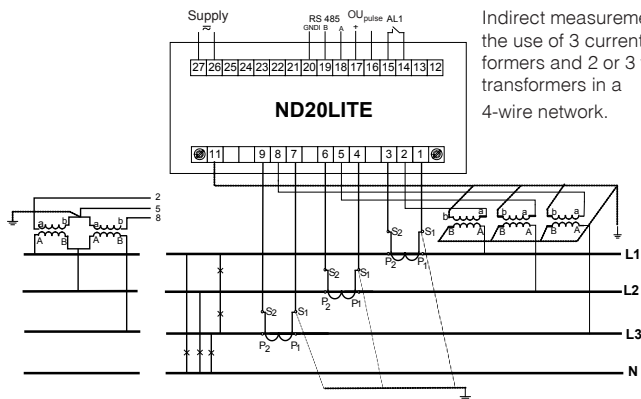

Indirect measurement with
the use of 3 current trans-
formers and 2 or 3 voltage
transformers in a
4-wire network.

Fig 3. Meter connection diagrams in a:
a) single-phase network, b) 3-phase - 3 wire network,
c) 3-phase - 4-wire network

6. ND20LITE PROGRAMMING

6.1 Frontal Panel

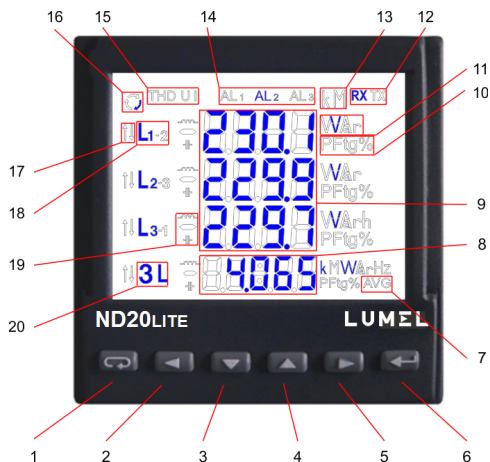

Fig 4. Frontal panel

Description of the frontal panel:

- | | |
|------------------------------------------------------------------------------------|----------------------------------------------------------|
| 1 – abandon push-button – ESC | 11 – units of displayed values |
| 2 – push-button to displace to the left | 12 – symbols of digital data transmission |
| 3 – push-button to decrease the value | 13 – multipliers of basic values |
| 4 – push-button to increase the value | 14 – symbols of alarm switching on / occurrence |
| 5 – push-button to displace to the right | 15 – symbols of THD display |
| 6 – acceptance push-button - ENTER | 16 – symbols of energy flow |
| 7 – symbol of displayed value of averaged active power | 17 – symbols of min / max quantities |
| 8 – display field of mean values, frequency, time, power guard | 18 – symbols of quantity affiliation to respective phase |
| 9 – display field of basic quantities, energy, THD, | 19 – symbols of power, energy character |
| 10 – symbols indicating the display of power factor, power tangent and THD (row 4) | 20 – symbol of 3-phase quantity display |

6.2 Messages after Switching the Supply on

After switching the supply on, the meter performs the display test and display the ND20LITE meter name, meter version, serial number and the current program version.

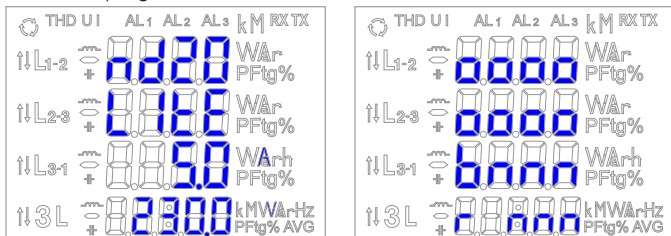

where:

00000000 - is the serial number

r n.nn - is the number of the current program version or the number of the custom-made version.







bnnn - is the number of boatloader version.

Fig. 5. Message after starting the meter

Caution! If on displays the message **Err Cal** or **Err EE** appears, one must contact the service shop.

6.3 Monitoring of Parameters

In the measuring mode, quantities are displayed acc. to settled tables.

The pressure of the  push-button (left) or  push-button (right) causes the transition between displayed quantities. The pressure of the  push-button (Enter) causes the transition between mean and additional displayed values. The pressure of the  push-button (down) causes the monitoring of the minimum value, however the pressure of the  push-button (up) causes the monitoring of the maximum value. The pressure of the  (ESC) push-button during the monitoring of these values, erases suitably minimum or maximum values. Through the RS-485 interface one can set up the values, that would be visualized.

The error display is described in the chapter 8.

When displaying the reactive power, a marker indicating the load character is displayed, capacitive (⏏) or inductive (⏏)

Displayed quantities in the field 9 (fig. 4.) for 3-phase 4-wire measurement mode 3Ph/4W and single-phase 1Ph/2W are presented in the table 1a and 1b.

Table 1a

Backlit symbols		L1, V L2, V L3, V	L1-2, V L2-3, V L3-1, V	L1, A L2, A L3, A	L1, W L2, W L3, W	L1, Var L2, Var L3, Var	L1, VA L2, VA L3, VA	L1, PF L2, PF L3, PF	L1, tg L2, tg L3, tg	kWh
Displayed values	row 1	U1	U12 ¹	I1	P1	Q1	S1	PF1	tg1	Imported active energy 2
	row 2	U2 ¹	U23 ¹	I2 ¹	P2 ¹	Q2 ¹	S2 ¹	PF2 ¹	tg2 ¹	
	row 3	U3 ¹	U31 ¹	I3 ¹	P3 ¹	Q3 ¹	S3 ¹	PF3 ¹	tg3 ¹	
Displaying		optional								

Backlit symbols		-, kWh	⏏ kVarh	⏏ kVarh	kVAh	L1,% L2,% L3,% , THD U
Displayed values	row 1	Exported active energy ²	reactive inductive energy / reactive positive energy ²	reactive capacitive energy / reactive negative energy ²	apparent energy ²	THD U1 % ¹
	row 2					THD U2 % ¹
	row 3					THD U3 % ¹
Displaying		optional				

Backlit symbols		L ₁ , % L ₂ , % L ₃ , %, THD I	c	W var VA
Displayed values	row 1	THD I1 % ¹	cosinus ϕ 1	P _{3phase} ¹
	row 2	THD I2 % ¹	cosinus ϕ 2 ¹	Q _{3phase} ¹
	row 3	THD I3 % ¹	cosinus ϕ 3 ¹	S _{3phase} ¹
Displaying		optional		

Displayed quantities in the field 8 (fig. 4.)

Table 1b

Displayed symbols	3L, A	A	3L, W	3L, var	3L, VA	3L, PF	3L, tg	3L, W _{AVG}
Displayed values in the row 4	I _{mean} 3phase ¹	I(N) ¹	P 3phase ¹	Q 3phase ¹	S 3phase ¹	PF _{mean} 3phase ¹	tg _{mean} 3phase ¹	P _{3phase} (15, 30 or 60 min) ²
Displaying	optional							



Backlit symbols	3L, c		Hz	%	3L, THD U	3L, THD I
Displayed values in the row 4	cosinus(ϕ) 3phase ¹	hour : minutes	frequency	Consumption of ordered power (in 15, 30 or 60 minutes' time) ²	THD U _{mean} % ¹	THD I _{mean} % ¹
Displaying	optional					

In 1Ph/2W measurement mode:

- 1 - values are not calculated and not displayed,
- 2 - values calculated as corresponding values of first phase

Displayed quantities in the field 9 (fig. 4.) for 3-phase 3-wire measurement mode 3Ph/3W and single-phase 1Ph/2W are presented in the table 2a and 2b.

Table 2a

Backlit symbols		L ₁₋₂ , V L ₂₋₃ , V L ₃₋₁ , V	L ₁ , A L ₂ , A L ₃ , A	kWh	-, kWh	 kvar	 kvar
Displayed values	row 1	U12	I1	imported active energy	exported active energy	reactive inductive energy / reactive positive energy	reactive capacitive energy / reactive negative energy
	row 2	U23	I2				
	row 3	U31	I3				
Displaying		optional					

Displayed symbols		kVAh	W var VA
Displayed values	row 1	apparent energy	P _{3phase}
	row 2		Q _{3phase}
	row 3		S _{3phase}
Displaying		optional	

Displayed quantities in the field 8 (fig. 4.)

Table 2b

Displayed symbols	3L, A	3L, W	3L, var	3L, VA	3L, PF	3L, tg	3L, W _{AVG}
Displayed values in the row 4	I _{mean 3phase}	P _{3phase}	Q _{3phase}	S _{3phase}	PF _{mean 3phase}	t _{gmean 3phase}	P _{3phase (15, 30 or 60 min)}
Displaying	optional						

Backlit symbols	3L, c		Hz	%
Displayed values in the row 4	cosinus(Φ) _{3phase}	hour : minutes	frequency	Consumption of ordered power (in 15, 30 or 60 minutes' time)
Displaying	optional			

Performed calculations:

Reactive power (the calculation method configured):

$$Q = \sqrt{S^2 - P^2}$$

$$^1 \text{ or } Q = \sum_{i=1}^k U_i * I_i * \sin(\angle U_i, I_i)$$

where k – harmonic number (k = 21 dla 50 Hz, k = 18 dla 60 Hz)

Power factor PF: $PF = P / S$

Tangens power: $tg\varphi = Q / P$

Cosinus: cosinus between U and I

The exceeding of the upper indication range is signaled on the display by upper horizontal lines, however the exceeding of the lower range is signaled by lower horizontal lines.

In case of averaged power measurement $P_{3\text{-phase}}$, single measurements are carried out with a 15 seconds' quantum. Suitably to the 15 min, 30 min, 60 min selection, 60, 120 or 240 measurements are averaged. After starting the meter or the power erasing, the first value will be calculated after 15 seconds since the meter switching on or erasing. Till the time to obtain all active power samples, the value of averaged power is calculated from already measured samples.

The current in the neutral wire $I_{(N)}$ is calculated from phase current vectors

The value of consumed ordered power can be used for a previous warning against the exceeding of ordered power and to escape of fines related with it. The consumption of ordered power is calculated on the base of time interval set for the synchronization of the mean active power and the value of ordered power (section 6.5.1). The consumption example is presented in the section 6.5.3.

The alarm switching on is signaled by the lighting of the AL1 inscription (in the mode A3non, A3nof, A3_on, A3_of: of AL1, AL2, AL3 inscriptions). The end of alarm duration at the alarm signaling support switched on, is indicated by the pulsation of the AL1 inscription (in the mode A3non, A3nof, A3_on, A3_of: of AL1, AL2, AL3 inscriptions).

6.4 Operating modes

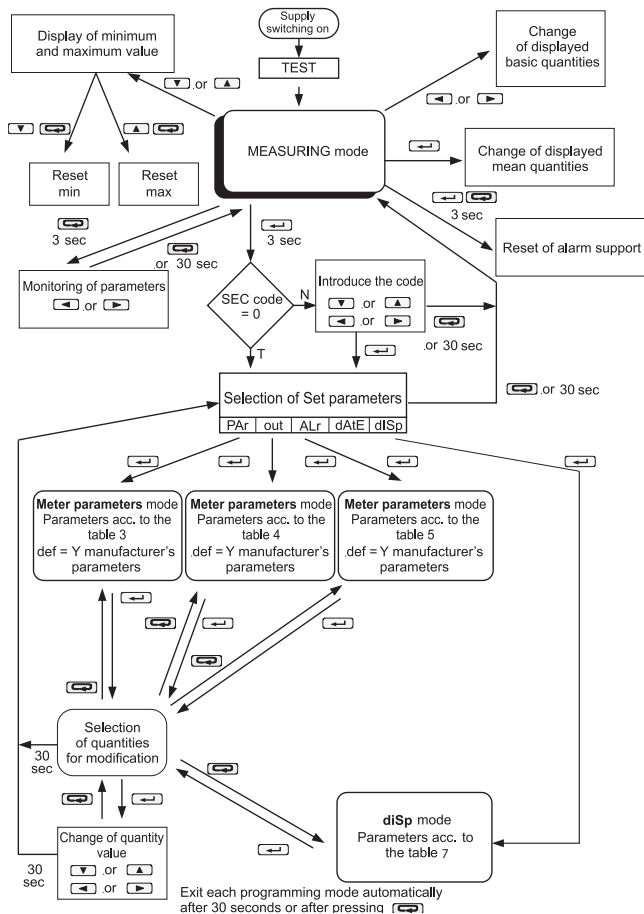

Fig. 6. Operating modes of the ND20LITE meter.

6.5. Parameter Settings

To configure the ND20LITE meter is free eCon software available on the www.lumel.com.pl.

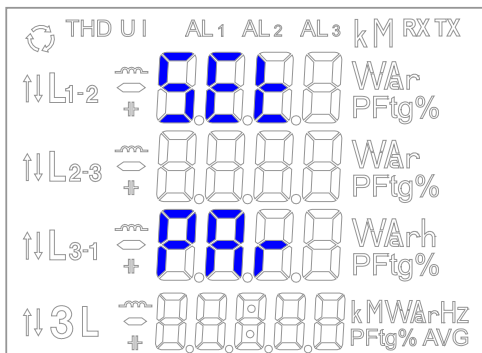



Fig 7. Setup menu

The entry in the programming mode is carried out through the pressure and holding down of the  push-button during ca 3 sec. The entry in the programming mode is protected by the access code. If there is not such a code, the program transits into the programming option. The inscription SET is displayed (in the first row) and the first group of PAR parameters. The monitoring of parameters is always available through the pressure and holding down the  push-button during ca 3 sec.

PAR Meter parameters	SEC Access code	CR-I Current ratio	CR-U Voltage ratio	SSn Synchronizing of the active mean power	ERLI Storage of the maximum value with errors	g Way to reactive power count	EN-9 Way to copy active energy	LCHK Display of the blink	EN-D Error of water-hour meters	PR-D Error of active mean power	PROR Ordered power	COA Type of system connection	t-H Hour, minute	dEF Manufacturing parameters
OUT Output parameters	io-n Quantity of impulses	ADDR Addresses in BUS network	tr-5b Transmission mode	BRUD Baud rate	dEF Manufacturing parameters	g Way to reactive power count	EN-9 Way to copy active energy	LCHK Display of the blink	EN-D Error of water-hour meters	PR-D Error of active mean power	PROR Ordered power	COA Type of system connection	t-H Hour, minute	dEF Manufacturing parameters
ALR Alarm parameters	RL-n Quantity on the continuous-duty (table 6 in the user's manual)	RL-t Alarm type	RL-OF Lower value of the input range	RL-on Higher value of the input range	RL-otb Time delay of the switching reaction	RL-S Support of the alarm advance signaling	RL-b Lock of re-switching	dEF Manufacturing parameters	EN-D Error of active mean power	PR-D Error of active mean power	PROR Ordered power	COA Type of system connection	t-H Hour, minute	dEF Manufacturing parameters
dISP Displayed values	U-LN Phase voltages L-N	U-LL L-L Voltages	I-LN Phase currents	P Phase active powers	g Phase reactive powers	S Phase apparent powers	PF Power factors phase	tC Three phase fan-lights	ENP Imported active energy	ENP Exported active energy	ENG Reactive inductive energy	ENG Reactive capacitive energy	ENs Apparent energy	tHdU THD of phase voltages
	tHdI THD phase currents	cos Phase Cosinus ϕ	PSS Power Phase Cosinus ϕ	I-R Three-phase mean current	I-n Current in neutral wire	3P Power 3P3-phase	3P Power 3P3-phase	3S Power 3P3phase	PF-R Three-phase Power Factor PF	PRU Power 3Phase (15 30 minutes)	ENG Reactive inductive energy	ENG Reactive capacitive energy	Hour Hour	F-EN Frequency
	tH3 mean THD of phase voltages	tH3 THD of phase voltages	ON Display of parameters - ON	OFF Display of parameters - OFF	OFF Display of parameters - OFF									

Fig. 8. Programming matrix.

6.5.1 Setting of Meter Parameters

Select the **PAr** mode in options (by  or  push-buttons) and approve the choice by the  push-button.







Table 3

Item	Parameter name	Designation	Range	Notes/ description	Manufacturer's value
1	Introduction of the access code	SEc	oFF, 1 ... 60000	0 - without code	0
2	Ratio of the current transformer	tr_I	1 ... 10000		1
3	Ratio of the voltage transformer	tr_U	0.1 ... 4000.0		1
4	Synchronization of mean active power	Syn	15, c_15, c_30, c_60	Synchronization of mean active power: 15 - 15 minutes' walking window (record synchronized with the clock every 15 minutes) c_15 – measurement synchronize with the clock every 15 minutes. c_30 – measurement synchronized with the clock every 30 minutes, c_60 – measurement synchronized with the clock every 60 minutes,	15
5	Storage of minimum and maximum values with errors	erLI	oFF, on	oFF – storage of only correct values (from the measuring range). on – storage of also error occurrences in measurements (values in registers 1e20 and 1e20)	on

6	Way to calculate reactive power	q_t	trGLE, SIInUS	$\text{TrGLE: } Q = \sqrt{S^2 - P^2}$ $\text{SIInUS: } Q = \sum_{i=1}^k U_i * I_i * \sin(\angle U_i, I_i)$ <p>k - harmonic number, k = 21 for 50 Hz, k = 18 for 60 Hz</p>	trGLE
7	Way to calculate reactive energy	En_q	cAP, SIGn	<p>cAP – inductive and capacitive energy</p> <p>SIGn – positive and negative energy</p>	cAP
8	Display backlight	LGht	oFF, 1 .. 60, on	<p>off – disabled, on – enabled, 1..60 – time in seconds of backlight support since the push-button pressure.</p>	on
9	Erasing of watt-hour meters	En_0	no, EnP, Enq, EnH, ALL	<p>no – lack of actions, EnP – erasing of active energy, Enq – erasing of reactive energy, EnH – erasing of harmonic energy. ALL – erasing of all energy</p>	no
10	Erasing of mean active power	PA_0	no, yES	yES -erasing of power	no
11	Reset of mean active power archive	PAr0	no, yES	yES - erasing of archive	no
12	Ordered power	PAor	0...144.0	Ordered power for forecasting the power consumption in % of the rated value	100.0
13	Measurement mode	conn	3Ph-4, 3Ph-3, 1Ph-2	Meter connection way	3Ph-4
14	Manufacturer's parameters	dEf	no, yES	Restoration of manufacturer's parameters of the group.	no

The automatic erasing of energy is carried out:

- for active energy when changing: voltage or current ratio;
- for reactive energy when changing: voltage or current ratio, the way of reactive power calculation.

Values are set by means of  and  push-buttons, however the position of the set digit is selected by means of  and  push-buttons. The active position is signaled by the cursor. The value is accepted by  the push-button and resigned by the pressure of the  push-button. During the acceptance, the value insertion possibility in the range is checked. In case when the value is set beyond the range, the meter remains in the parameter edition mode, however the value is set on the maximum value (when the value is too higher) or on the minimum value (when the value is too lower).

6.5.2. Setting of Output Parameters

Select the **out** mode in options and approve the choice by the  push-button.

Table 4

Item	Parameter name	Designation	Range	Notes/description	Manufacturer's value
1	Number of impulses	lo_n	1000 ... 20000	Number of impulses for 1 kWh	5000
2	Address in MODBUS network	Addr	1 ... 247		1
3	Transmission mode	trYb	r8n2, r8E1, r8o1, r8n1		8n2
4	Baud rate	bAUd	4.8 k, 9.6 k, 19.2 k, 38.4 k		9,6 k
5	Manufacturer's parameters	dEf	no, yES	Restoration of manufacturer's parameters of the group	no

6.5.3. Setting of Alarm Parameters



Select the **ALr** mode in options and approve the choice by the  push-button.

Table 5

Item	Parameter name	Designation	Range	Notes/description	Manufacturer's value
1	Quantity in the alarm output	AL_n	table 6	(code acc. to the table 6)	P
2	Alarm type	AL_t	n-on, n-oFF, on, oFF, H-on, H-oFF, A3non, A3nof, A3_on, A3_of	Fig. 9	n-on
3	Lower value of the input range	ALoF	-144.0 ... 144.0	in % of the rated quantity value	99,0
4	Upper value of the input range	ALon	-144.0 ... 144.0	in % of the rated quantity value	101,0
5	Time delay of the switching reaction	ALdt	0 ... 900	in seconds (for quantities AL_n =P_ord the delay occurs only when switching the alarm on)	0
6	Support of the alarm occurrence signaling	AL_S	oFF, on	In the situation when the support function is enabled, after the retreat of the alarm state the alarm symbol is not blanked but begins to pulsate. The signaling exists till the moment of blanking it by means of the  and  push-buttons combination (during 3 seconds). The function concerns only and exclusively the alarm signaling, then relay contacts will be active without support, acc. to the selected type of alarm.	oFF
7	Interlocking of a renewed alarm switching on	AL_b	0...900	in seconds	0
8	Manufacturer's parameters	dEF	no, yES	Restoration of manufacturer's parameters of the group.	no

The write of the value ALon lower than ALoF switches the alarm off.

Selection of the monitored value:

Table 6

Item/ value in re- gister 4015	Displayed parameter	Kind of quantity	Value for the percentage conversion of alarm valu- es and outputs (100%)
00	off	lack of quantity /alarm disabled/	none
01	U_1	voltage of phase L1	U_n [V] *
02	I_1	current in the phase wire L1	I_n [A] *
03	P_1	active power of phase L1	$U_n \times I_n \times \cos(0^\circ)$ [W] *
04	q_1	reactive power of phase L1	$U_n \times I_n \times \sin(90^\circ)$ [var] *
05	S_1	apparent power of phase L1	$U_n \times I_n$ [VA] *
06	PF1	active power factor PF of phase L1	1
07	tg1	$\text{tg}\phi$ coefficient of phase L1	1
08	U_2	voltage of phase L2	U_n [V] *
09	I_2	current in the phase wire L2	I_n [A] *
10	P_2	active power of phase L2	$U_n \times I_n \times \cos(0^\circ)$ [W] *
11	q_2	reactive power of phase L2	$U_n \times I_n \times \sin(90^\circ)$ [var] *
12	S_2	apparent power of phase L2	$U_n \times I_n$ [VA] *
13	PF2	active power factor PF of phase L2	1
14	tg2	$\text{tg}\phi$ coefficient of phase L2	1
15	U_3	voltage of phase L3	U_n [V] *
16	I_3	current in the phase wire L3	I_n [A] *
17	P_3	active power of phase L3	$U_n \times I_n \times \cos(0^\circ)$ [W] *
18	q_3	reactive power of phase L3	$U_n \times I_n \times \sin(90^\circ)$ [var] *
19	S_3	apparent power of phase L3	$U_n \times I_n$ [VA] *
20	PF3	active power factor PF of phase L3	1

21	tg3	tg ϕ coefficient of phase L3	1
22	U_A	mean 3-phase voltage	Un [V] *
23	I_A	mean 3-phase current	In [A] *
24	P	3-phase active power (P1 + P2+ P3)	3 x Un x In x cos(0°) [W] *
25	q	3-phase reactive Power (Q1 + Q2 + Q3)	3 x Un x In x sin(90°) [var] *
26	S	3-phase apparent Power (S1 + S2 + S3)	3 x Un x In [VA] *
27	PF_A	3-phase active power factor PF	1
28	Tg_A	3-phase tg ϕ coefficient	1
29	FrEq	frequency	100 [Hz]
30	U12	phase-to-phase voltage L1-L2	$\sqrt{3}$ Un [V] *
31	U23	phase-to-phase voltage L2-L3	$\sqrt{3}$ Un [V] *
32	U31	phase-to-phase voltage L3-L1	$\sqrt{3}$ Un [V] *
33	U4_A	mean phase-to-phase voltage	$\sqrt{3}$ Un [V] *
34	P_At	mean active power	3 x Un x In x cos(0°) [W] *
35	P_ord	Used percentage of the ordered active power (consumed energy)	100%

*Un, In – rated values of voltages and currents

a) n-on

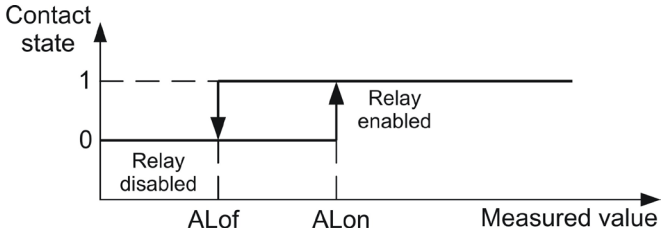

b) n-off

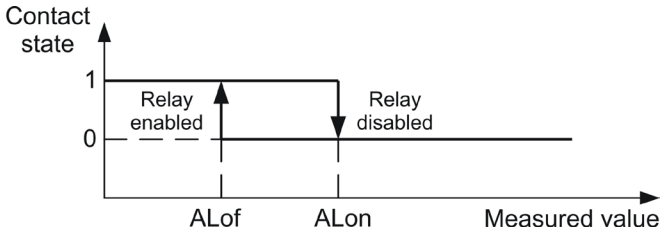

c) On

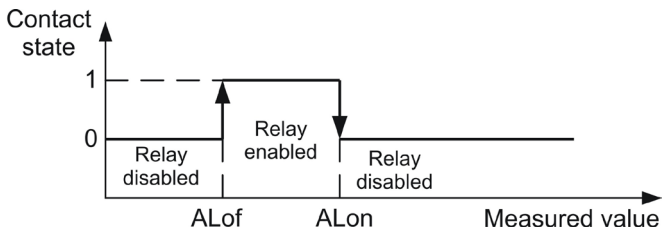

d) OFF

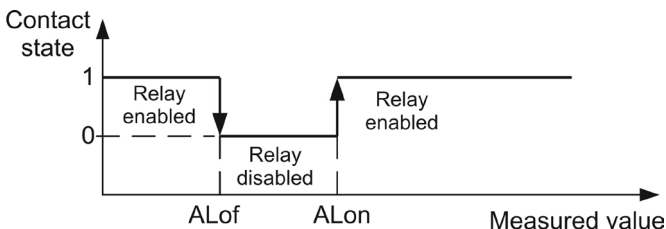
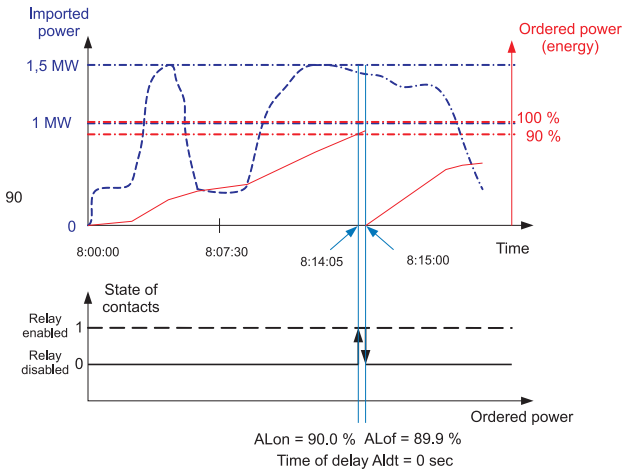

Fig. 9. Alarm types: a),b) normal c) enabled d) disabled

Remaining types of the alarm:

- H-on – always enabled;
- H-off – always disabled,
- A3non – when the “n-on” alarm type occurs on any of the phases – the relay switches on and the corresponding symbol is illuminated (AL1 – phase 1, AL2 – phase 2, AL3 – phase 3). When all alarms fade away, the relay switches off.
- A3nof – when the “n-off” alarm type occurs on any of the phases – the relay switches on and the corresponding symbol is illuminated (AL1 – phase 1, AL2 – phase 2, AL3 – phase 3). When all alarms fade away, the relay switches off.



An example of the parameter value utilization of ordered active power to switch the alarm on is presented on the fig. 10. The time delay is set on 0 sec. In the calculated example, for remaining 10% of ordered power, at the maximum power consumption, devices could still work during 60 sec without exposing customers to fines. when setting the time delay ALdt on 60 sec, the alarm would not be enabled.

Fig 10. Measurement of 60 minutes' active power consumption synchronized with the clock, with alarm set on a 90% consumption.

Set: Monitored quantity: P_ord, Kind of alarm: n-on, ALon = 90.0, ALoF = 89.9, Tr_1 = 500, Syn = c_60, Time delay ALdt = 0 or 240 s.

6.5.4. Setting of displayed values

Select the **DISP** mode in options and approve the choice by the  push-button.

Table 7

No.	Parameter name	Designation	Range	Manufacturer's value
Displayed parameters in the row 1 - 3				
1	Phase voltages	U_Ln	oFF, on	on
2	Phase-to-phase voltages	U_LL	oFF, on	on
3	Phase currents	I_Ln	oFF, on	on
4	Active phase powers	P	oFF, on	on
5	Reactive phase powers	q	oFF, on	on
6	Apparent phase powers	S	oFF, on	on
7	Phase PF power factors	PF	oFF, on	on
8	Phase Tangents φ factors	tG	oFF, on	on
9	Input active energy	EnP	oFF, on	on
10	Output active energy	EnP-	oFF, on	on
11	Inductive reactive energy	Enq	oFF, on	on
12	Capacity reactive energy	Enq-	oFF, on	on
13	THD of phase voltage	tHdu	oFF, on	on
14	THD of phase current	tHdl	oFF, on	on
15	Harmonic input active energy	EnH	oFF, on	on
16	Harmonic output active energy	EnH-	oFF, on	on
17	Phase Cosinus φ	cos	oFF, on	on
18	3-phase active, reactive, apparent power	PqS	oFF, on	on

Displayed parameters in the row 4				
19	Three-phase mean current	I_A	oFF, on	on
20	Current in neutral wire	I_n	oFF, on	on
21	Three-phase active power	3P	oFF, on	on
22	Three-phase reactive power	3q	oFF, on	on
23	Three-phase apparent power	3S	oFF, on	on
24	Three-phase mean power factor PF	PF_A	oFF, on	on
25	Three-phase mean Tangent φ factor	tG_A	oFF, on	on
26	Three-phase mean active power (15,30 or 60 minutes)	PAvG	oFF, on	on
27	Three-phase mean Cosinus φ	coSA	oFF, on	on
28	Hour	HoUr	oFF, on	on
29	Frequency	Freq	oFF, on	on
30	Three-phase ordered power	p_or	oFF, on	on
31	Mean THD of phase voltages	tH3U	oFF, on	on
32	Mean THD of phase currents	tH3I	oFF, on	on
33	Display of parameters - ON	on	no, YES	no
34	Display of parameters - OFF	off	no, YES	no

Note! When you turn off the display of all parameters, the phase current values and frequency are displayed.

7. UPDATING OF SOFTWARE

Function enabling updating of software from the computer of the PC with software eCon was implementation in meter ND20LITE. Free software eCon and update files are accessible on the site www.lumel.com.pl. The connected to the computer converter RS485 is required on USB to the updating, e.g.: the converter PD10.

a)

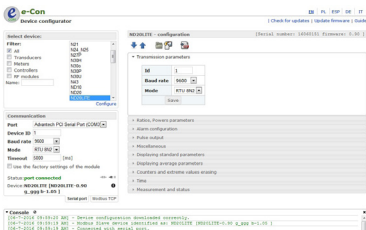

b)

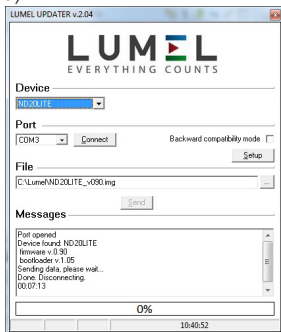



Fig. 13. Program view: a) eCon, b) updating of software

Note! After updating the software, the manufacturer's settings of the meter should be set, so it is recommended to save the meter parameters before updating using the software eCon.

After starting eCon's software COM port, baudrate, transmission mode and address should be set. It can be done in *Options*. Then, ND20LITE meter should be selected from *Device*. Push icon *Load* to read and save current settings. Open window *Lumel Updater (LU)* – figure 13b from *Updating->Updating of devices firmware*. Push *Connect*. Update progress is shown in *Messages* section. Text *Port opened* appear after correctly opened port. Putting meter in update's mode can be done in two ways: remote from LU (with settings from eCon – port, baudrate, transmission mode and address) or by turning power on while  button pressed. Meter display shows the „boot“ inscription with bootloader version, LU shows message „*Device found*“ with name and current version of firmware. Using button  browse to the meter upgrade file. If the file is opened correctly, a *File opened* message is displayed. Press the *Send* button. When upgrade is successfully completed, meter reverts to the default settings and begins normal operation while the information window displays *Done* message and upgrade elapsed time. Close LU and go to *Restoration of default parameters*. Select checkbox and press *Apply* button. After the LU window is closed, press the *Save* icon to save all initially read parameters. Current firmware version can be checked when meter is power on.

Warning! Turning the meter off during upgrade process may result in permanent damage!

8. RS-485 INTERFACE

The implemented protocol is compliant with the PI-MBUS-300 Rev G, Modicon. Parameter set of the serial ND20LITE meter link:

- identifier 0xDC
- meter address: 1..247
- baud rate 4.8, 9.6, 19.2, 38.4 kbit/s,
- working mode Modbus RTU,
- information unit 8N2, 8E1, 8O1, 8N1,
- maximum time to response start 600 ms.
- maximum quantity of read out registers in one request
 - 41 registers – 4 byte registers,
 - 82 registers – 2 byte registers,
- implemented functions 03, 04, 06, 16, 17,
 - 03, 04 - readout of registers,
 - 06 - write of one register,
 - 16 - write of n-registers,
 - 17 - device identification,

Manufacturer's settings: address 1, baud rate: 9600 baud, RTU 8N2 mode,

Readout of n-registers (code 03h)

Example 1 . Readout of 2 registers 16-bit of integer type, starting with the register with the 0FA0h (4000) address - register values 10, 100.

Request:

Device address	Function	Register address		Number of registers		CRC Control sum
		B1	B0	B1	B0	
01	03	0F	A0	00	02	C7 3D

Response:

Device address	Function	Number of bytes	Register address 0FA0 (4000)		Number of registers 0FA1 (4001)		CRC Control sum
			B1	B0	B1	B0	
01	03	04	00	0A	00	64	E4 6F

Example 2 . Readout of 2 registers 32-bit of float type as 2 registers 16-bits, starting with the register with the 1B58h (7000) address - register values 10, 100.

Request:

Device address	Function	Register address		Number of registers		CRC Control sum
		B1	B0	B1	B0	
01	03	1B	58	00	04	C3 3E

Response:

Device address	Function	Number of bytes	Value from register 1B58 (7000)		Value from register 1B59 (7001)		Value from register 1B5A (7002)		Value from register 1B5B (7003)		CRC Control sum
			B3	B2	B1	B0	B3	B2	B1	B0	
01	03	08	41	20	00	00	42	C8	00	00	E4 6F

Example 3 . Readout of 2 registers 32-bit of float type as 2 registers 16-bit, starting with the register with the 1770h (6000) address - register values 10, 100.

Request

Device address	Function	Register address		Number of registers		CRC Control sum
		B1	B0	B1	B0	
01	03	17	70	00	04	4066

Response:

Device address	Function	Number of bytes	Value from register 1770h (6000)		Value from register 1770h (6000)		Value from register 1772h (6002)		Value from register 1772h (6002)		CRC Control sum
			B1	B0	B3	B2	B1	B0	B3	B2	
01	03	08	00	00	41	20	00	00	42	C8	E4 6F

Example 4 . Readout of 2 registers 32-bit of float type, starting with the register with the 1D4Ch (7500) address - register values 10, 100.

Request:

Device address	Function	Register address		Number of registers		CRC Control sum
		B1	B0	B1	B0	
01	03	1D	4C	00	02	03 B0

Response:

Device address	Function	Number of bytes	Value from register 1D4C (7500)				Value from register 1D4D (7501)				CRC Control sum
			B3	B2	B1	B0	B3	B2	B1	B0	
01	03	08	41	20	00	00	42	C8	00	00	E4 6F

Recording a single register (code 06h)

Example 5 . Recording the value 543 (0x021F) in the register 4000 (0x0FA0)

Request:

Device address	Function	Register address		Number of registers		CRC Control sum
		B1	B0	B1	B0	
01	06	0F	A0	02	1F	CA 54

Response:

Device address	Function	Register address		Number of registers		CRC Control sum
		B1	B0	B1	B0	
01	06	0F	A0	02	1F	CA 54

Recording to n-registers (code 10h)

Example 6 . Recording 2 registers starting with the register with the 0FA3h (4003) address recorded values 20, 2000.

Request:

Device address	Function	Register addr. Hi	Register addr. Lo	Register addr. Hi	Register addr. Lo	Number of bytes	Value for register 0FA3 (4003)		Value for register 0FA4 (4004)		CRC Control sum
							B1	B0	B1	B0	
01	10	0F	A3	00	02	04	00	14	07	D0	BB 9A

Response:

Device address	Function	Register address		Number of registers		CRC Control sum
		B1	B0	B1	B0	
01	10	0F	A3	00	02	B2 FE

Report identifying the device (code 11h)

Example 7 . Device identification

Request: Table 8

Device address	Function	CRC Control sum
01	11	C0 2C

Response:

Device address	Function	Number of bytes	Identifier	Device status	Information field of the device software version (eg, „ND20LITE-0.09 b-1.05” - ND20 device with software version 0.09 and bootloader version 1.05)	CRC Control sum
01	11	1D	DC	FF	4E 44 32 30 4C 49 54 45 2D 30 2E 39 20 20 20 20 20 20 20 62 2D 31 2E 30 35 20	DB 84

Map of ND20 meter registers

In the ND20LITE meter, data are placed in 16 and 32-bit registers. Process variables and meter parameters are placed in the address area of registers in a way depended on the variable value type. Bits in 16-bit registers are numbered from the youngest to the oldest (b0-b15). 32-bit registers include numbers of float type in IEEE-754 standard.

Table 8

Address range	Type of value	Description
4000 – 4055	Integer (16 bits)	The value is placed in one 16-bit register. The table 11 includes the register description. Registers for write and readout.
6000 – 6319	Float (2x16 bits)	Value placed in two successive 16-bit registers. Registers include the same data as 32-bit registers from the area 7500 – 7659. Registers for readout. Sequence of bytes (1-0-3-2).
6320 – 6573	Float (2x16 bits)	Value placed in two successive 16-bit registers. Registers include the same data as 32-bit registers from the area 7660 – 7786. Registers for readout. Sequence of bytes (1-0-3-2).
7000 – 7319	Float (2x16 bits)	Value placed in two successive 16-bit registers. Registers include the same data as 32-bit registers from the area 7500 – 7659. Registers for readout. Sequence of bytes (3-2-1-0).

7500 – 7659	Float (32 bits)	Value placed in one 32-bit register. The table 10 includes the register description. Registers for readout.
7660 – 7786	Float (32 bits)	Value placed in one 32-bit register. The table 10 includes the register description. Registers for readout.
7800 – 8052	Float (2x16 bits)	Value placed in two successive 16-bit registers. Registers include the same data as 32-bit registers from the area 7660 – 7786. Registers for readout. Sequence of bytes (3-2-1-0).

Table 9

Register address	Operation	Range	Description	By default
4000	RW	0..60000	Protection - password	0
4001	RW	0...900 [s]	Interlocking time of the renewed switching of the relay output on	0
4002	RW	0...1440 [‰]	Ordered mean power *10	1000
4003	RW	1..10000	Current transformer ratio	1
4004	RW	1..40000	Voltage transformer ratio *10	10

4005	RW	0..3	<p>Synchronization of mean active power:</p> <p>0 – 15 minutes' walking window (record synchronized every 15 minutes with the clock)</p> <p>1 – measurement synchronized every 15 minutes with the clock</p> <p>2 – measurement synchronized every 30 minutes with the clock</p> <p>3 – measurement synchronized every 60minutes with the clock</p>	0
4006	RW	0	reserved	0
4007	RW	0,1	<p>Storage way of minimum and maximum values</p> <p>0 – without errors,</p> <p>1 – with errors</p>	0
4008	RW	0,1	<p>Way to calculate reactive power:</p> $0: Q = \sqrt{S^2 - P^2}$ $1: Q = \sum_{i=1}^k U_i * I_i * \sin(\angle U_i, I_i)$ <p>k – harmonic number, k = 21 for 50 Hz, k = 18 for 60 Hz</p>	0
4009	RW	0,1	<p>Way to calculate reactive energy:</p> <p>0 – inductive and capacitive energy</p> <p>1 – positive and negative energy</p>	0
4010	RW	0...61	<p>Display backlit:</p> <p>0 – disabled,</p> <p>1-60 – backlit time in seconds since the push-button pressure,</p> <p>61 – always enabled</p>	61

4011	RW	0..4	Erasing of watt-hour meters: 0 – without changes, 1- erase active energy, 2 – erase reactive energy, 3 – erase energy of harmonics, 4 – erase all energy.	0
4012	RW	0,1	Erasing of mean active power P_{AV}	0
4013	RW	0	reserved	0
4014	RW	0,1	Erase min and max	0
4015	RW	0,1 .. 35	Quantity on the alarm relay output (code acc. to the table 6)	24
4016	RW	0 ... 9	Output type: 0 – n-on, 1– n-off, 2 – on, 3 - off, 4 – H-on, 5 – H-off, 6 - A3non, 7 - A3nof, 8 - A3_on, 9 - A3_of	0
4017	RW	-1440..0.. 1440 [%∞]	Lower alarm switching value	990
4018	RW	-1440..0.. 1440 [%∞]	Upper alarm switching value	1010
4019	RW	0...900 s	Delay of the alarm switching (for quantity $AL_n = P_{ord}$ – rgister 4015 =35, the delay occurs only when the alarm is switched on.	0
4020	RW	1..2000 [10uA]	Alarm signaling support	0
4021	RW	0	reserved	0
4022	RW	0	reserved	0
4023	RW	0	reserved	0
4024	RW	0	reserved	0
4025	RW	0	reserved	0

4026	RW	0	reserved	0
4027	RW	0	reserved	0
4028	RW	0	reserved	0
4029	RW	1000.. 20000	Number of impulses for the impulse output	5000
4030	RW	1..247	Address in the MODBUS network	1
4031	RW	0..3	Transmission mode: : 0->r8n2, 1->r8E1, 2->r8o1, 3->r8n1	0
4032	RW	0..3	Baud rate: 0->4800, 1->9600 2->19200, 3->38400	1
4033	RW	0.1	Bring up to date the transmis- sion parameter change	0
4034	RW	0..2359	Hour *100 + Minutes	0
4035	RW	0	reserved	0
4036	RW	0	reserved	0
4037	RW	0,1	Record of standard parame- ters (together with the reset of energy and min, max, averaged power)	0
4038	R	0..15258	Imported active energy, two older bytes	0
4039	R	0.. 65535	Imported active energy, two younger bytes	0
4040	R	0..15258	Exported active energy, two older bytes	0
4041	R	0..65535	exported active energy, two younger bytes	0
4042	R	0..15258	Reactive inductive energy, two older bytes	0
4043	R	0..65535	Reactive inductive energy, two younger bytes	0

4044	R	0..15258	Reactive capacitive energy, two older bytes	0
4045	R	0..65535	Reactive capacitive energy, two younger bytes	0
4046	R	0..15258	Apparent energy, two older bytes	0
4047	R	0..65535	Apparent energy, two younger bytes	0
4048	R	0	reserved	0
4049	R	0	reserved	0
4050	R	0..65535	Status register – description below	0
4051	R	0..65535	Serial number, two older bytes	-
4052	R	0..65535	Serial number, two younger bytes	-
4053	R	0..65535	Program version (*100)	-
4054	RW	0..65535	Displayed parameters of standard values	0xFFFF
4055	RW	0..65535	Displayed parameters of average values	0xFFFF
4056	RW	0..65535	Displayed parameters of stan- dard values 2	0xFFFF
4057	RW	0...2	Measurement mode: 0->3Ph / 4W, 1->3Ph / 4W 2-> 1Ph/2W	0
4058	R	0..65535	nominal voltage x10	577, 2300
4059	R	0..65535	nominal current x10	100, 500
4060	R	0	reserved	0
4061	R	0..65535	Register of status 2 - description below	0

In parenthesis [], suitably is placed: resolution or unit.

Energy is made available in hundreds of watt-hours (var-hours) in double 16-bit register, and for this reason, one must divide them by 10 when calculating values of particular energy from registers, ie:

Imported active energy = (register 4038 value x 65536 + register 4039 value) /10 [kWh]

Exported active energy = (register 4040 value x 65536 + register 4041 value) /10 [kWh]

Reactive inductive energy = (register 4042 value x 65536 + register 4043 value) /10 [kVarh]

Reactive capacitive energy = (register 4044 value x 65536 + register 4045 value) /10 [kVarh]

Apparent energy = (register 4046 value x 65536 + register 4047 value) / 10 [kVAh]

Device status register (address 4050, R):

Bit 15 – „1” – damage of the non-volatile memory	Bit 7 – „1” – the interval of averaged power is not elapsed		
Bit 14 – „1” – lack of calibration or erroneous calibration	Bit 6 – „1” – frequency for THD calculation beyond intervals - 48 – 52 for frequency 50 Hz, - 58 – 62 for frequency 60 Hz		
Bit 13 – „1” – error of parameter values	Bit 5 – „1” – voltage too low for frequency measurements		
Bit 12 – „1” – error of energy values	Bit 4 – „1” – too low voltage of phase L3		
Bit 11 – „1” – error of phase sequence	Bit 3 – „1” – too low voltage of phase L2		
Bit 10 – current range „0” – 1 A~; „1” – 5 A~	Bit 2 – „1” – too low voltage of phase L1		
Bit 9	Bit 8	Voltage range	Bit 1 – reserved
0	0	57.7 V~	Bit 0 – state of relay output „1” – On, „0” - off
0	1	230 V~	

Register of status 2 - nature of the reactive power (address 4061, R):

Bit 15 – reserved	Bit 9 – „1” – capacitive 3L
Bit 14 – „1” – alarm indication in phase L3 (only for alarm type: A3non, A3nof, A3_on, A3_of)	Bit 8 – „1” – capacitive L3 maximum
Bit 13 – „1” – alarm indication in phase L2 (only for alarm type: A3non, A3nof, A3_on, A3_of)	Bit 7 – „1” – capacitive L3 minimum
Bit 12 – „1” – alarm indication in phase L1 (only for alarm type: n-on, n-off, on, off)	Bit 6 – „1” – capacitive L3
Bit 11 – „1” – capacitive 3L maximum	Bit 5 – „1” – capacitive L2 maximum
Bit 10 – „1” – capacitive 3L minimum	Bit 4 – „1” – capacitive L2 minimum
	Bit 3 – „1” – capacitive L2
	Bit 2 – „1” – capacitive L1 maximum
	Bit 1 – „1” – capacitive L1 minimum
	Bit 0 – „1” – capacitive L1

Configuration register of displayed parameters of standard values (address 4054, R/W):

Bit 15 ...”1” – displaying of cosinus φ	Bit 8 – „1” – displaying of imported active energy
Bit 14 – „1” – displaying of THD current	Bit 7 – „1” – displaying of tg
Bit 13 – „1” – displaying of THD voltage	Bit 6 – „1” – displaying of PF
Bit 12 – „1” – displaying of apparent energy	Bit 5 – „1” – displaying of phase apparent powers
Bit 11 – „1” – displaying of capacitive reactive energy	Bit 4 – „1” – displaying of phase reactive powers
Bit 10 – „1” – displaying of inductie reactive energy	Bit 3 – „1” – displaying of phase active powers
Bit 9 – „1” – displaying of exported active energy	Bit 2 – „1” – displaying of phase currents
	Bit 1 – „1” – displaying of phase-to-phase voltages
	Bit 0 – „1” – displaying of phase voltages

Configuration register of displayed parameters of standard values 2 (address 4056, R/W):

Bit 15 ... 1 – reserved

Bit 0 – „1” – displaying of power $\Sigma P, \Sigma Q, \Sigma S$

Register of status 2 - nature of the reactive power (address 4055, R/W):

Bit 15...14 – reserved

Bit 13 – „1” – displaying of mean THD current

Bit 12 – „1” – displaying of mean THD voltage

Bit 11 – „1” – displaying of ordered power utilization

Bit 10 – „1” – displaying of frequenz

Bit 9 – „1” – displaying of time

Bit 8 – „1” – displaying of mean φ cosinus

Bit 7 – „1” – displaying of mean active power

Bit 6 – „1” – displaying of mean tg

Bit 5 – „1” – displaying of mean PF

Bit 4 – „1” – displaying of power ΣS

Bit 3 – „1” – displaying of power ΣQ

Bit 2 – „1” – displaying of power ΣP

Bit 1 – „1” – displaying of current in neutral conductor

Bit 0 – „1” – displaying of mean current

Table 12

Address of 16-bit registers	Address of 32-bit registers	Operation	Description	Unit	3Ph/4W	3Ph/3W	3Ph/2W
6000/7000	7500	R	Voltage of phase L1	V	√	x	√
6002/7002	7501	R	Current in phase L1	A	√	√	√
6004/7004	7502	R	Active power of phase L1	W	√	x	√
6006/7006	7503	R	Reactive power of phase L1	var	√	x	√
6008/7008	7504	R	Apparent power of phase L1	VA	√	x	√
6010/7010	7505	R	Power factor (PF) of phase L1	-	√	x	√
6012/7012	7506	R	Tg φ factor of phase L1	-	√	x	√
6014/7014	7507	R	Voltage of phase L2	V	√	x	x
6016/7016	7508	R	Current in phase L2	A	√	√	x
6018/7018	7509	R	Active power of phase L2	W	√	x	x
6020/7020	7510	R	Reactive power of phase L2	var	√	x	x
6022/7022	7511	R	Apparent power of phase L2	VA	√	x	x
6024/7024	7512	R	Power factor (PF) of phase L2	-	√	x	x
6026/7026	7513	R	Tg φ factor of phase L2	-	√	x	x
6028/7028	7514	R	Voltage of phase L3	V	√	x	x
6030/7030	7515	R	Current in phase L3	A	√	√	x
6032/7032	7516	R	Active power of phase L3	W	√	x	x
6034/7034	7517	R	Reactive power of phase L3	var	√	x	x
6036/7036	7518	R	Apparent power of phase L3	VA	√	x	x
6038/7038	7519	R	Power factor (PF) of phase L3	-	√	x	x
6040/7040	7520	R	Tg φ factor of phase L3	-	√	x	x

6042/7042	7521	R	Mean 3-phase voltage	V	√	x	x
6044/7044	7522	R	Mean 3-phase current	A	√	√	x
6046/7046	7523	R	3-phase active power (P1+P2+P3)	W	√	√	x
6048/7048	7524	R	3-phase reactive power (Q1+Q2+Q3)	var	√	√	x
6050/7050	7525	R	3-phase apparent power (S1+S2+S3)	VA	√	√	x
6052/7052	7526	R	Mean power factor (PF)	-	√	√	x
6054/7054	7527	R	Mean Tg φ factor of phase L1	-	√	√	x
6056/7056	7528	R	Frequency	Hz	√	√	x
6058/7058	7529	R	Phase-to-phase voltage L1-2	V	√	√	x
6060/7060	7530	R	Phase-to-phase voltage L2-3	V	√	√	x
6062/7062	7531	R	Phase-to-phase voltage L3-1	V	√	√	x
6064/7064	7532	R	Mean phase-to-phase voltage	V	√	√	x
6066/7066	7533	R	3-phase 15, 30, 60 minutes' active Power (P1 + P2 + P3)	W	√	√	√
6068/7068	7534	R	THD U1	%	√	x	√
6070/7070	7535	R	THD U2	%	√	x	x
6072/7072	7536	R	THD U3	%	√	x	x
6074/7074	7537		THD U mean	%	√	x	x
6076/7076	7538	R	THD I1	%	√	x	√
6078/7078	7539	R	THD I2	%	√	x	x
6080/7080	7540	R	THD I3	%	√	x	x
6082/7082	7541	R	Cosinus of angle between U1 and I1	-	√	x	x
6084/7084	7542	R	Cosinus of angle between U2 and I2	-	√	x	x

6088/7088	7544	R	Cosinus of angle between U3 and I3	-	√	x	x
6090/7090	7545	R	3-phase mean cosinus	-	√	√	x
6092/7092	7546	R	Angle between U1 and I1	°	√	x	√
6094/7094	7547	R	Angle between U2 i I2	°	√	x	x
6096/7096	7548	R	Angle between U3 i I3	°	√	x	x
6098/7098	7549	R	Current in neutral wire (calculated from vectors)	A	√	x	x
6100/7100	7550	R	Imported 3-phase active energy (number of overflows in register 7549, reset after exceeding 99999999.9 kWh)	100 MWh	√	√	P1
6102/7102	7551	R	Imported 3-phase active energy (counter totting up to 99999.9 kWh)	kWh	√	√	P1
6104/7104	7552	R	Exported 3-phase active energy (number of overflows in register 7551, reset after exceeding 99999999.9 kWh)	100 MWh	√	√	P1
6106/7106	7553	R	Exported 3-phase active energy (counter totting up to 99999.9 kWh)	kWh	√	√	P1
6108/7108	7554	R	3-phase reactive inductive energy (number of overflows in register 7553, reset after exceeding 99999999.9 kVarh)	100 Mvarh	√	√	Q1
6110/7110	7555	R	3-phase reactive inductive energy (counter totting up to 99999.9 kVarh)	kvarh	√	√	Q1

6112/7112	7556	R	3-phase reactive capacitive energy (number of overflows in register 7555, reset after exceeding 99999999.9 kVarh)	100 Mvarh	√	√	Q1
6114/7114	7557	R	3-phase reactive capacitive energy (counter totting up to 99999.9 kVarh)	kvarh	√	√	Q1
6116/7116	7558	R	Apparent 3-phase power (number of overflows in register 7557, reset after exceeding 99999999.9 kVAh)	100 MVAh	√	x	x
6120/7118	7559	R	Apparent 3-phase power (counter totting up to 99999.9 kVAh)	kVAh	√	x	x
6120/7120	7560	R	reserved	-	-	-	-
6122/7122	7561	R	reserved	-	-	-	-
6124/7124	7562	R	Time – hours, minutes	-	√	√	√
6126/7126	7563	R	reserved	-	-	-	-
6128/7128	7564	R	reserved	-	-	-	-
6130/7130	7565	R	reserved	-	-	-	-
6132/7132	7566	R	Utilized ordered power	V	√	x	√
6134/7134	7567	R	reserved	-	-	-	-
6136/7136	7568	R	reserved	-	-	-	-
6138/7138	7569	R	reserved	-	-	-	-
6140/7140	7570	R	Voltage L1 min	V	√	x	√
6142/7142	7571	R	Voltage L1 max	V	√	x	√
6144/7144	7572	R	Voltage L2 min	V	√	x	x
6146/7146	7573	R	Voltage L2 max	V	√	x	x
6148/7148	7574	R	Voltage L3 min	V	√	x	x
6150/7150	7575	R	Voltage L3 max	V	√	x	x

6152/7152	7576	R	Current L1 min	A	√	√	√
6154/7154	7577	R	Current L1 max	A	√	√	√
6156/7156	7578	R	Current L2 min	A	√	√	x
6158/7158	7579	R	Current L2 max	A	√	√	x
6160/7160	7580	R	Current L3 min	A	√	√	x
6162/7162	7581	R	Current L3 max	A	√	√	x
6164/7164	7582	R	Active power L1 min	W	√	x	√
6166/7166	7583	R	Active power L1 max	W	√	x	√
6168/7168	7584	R	Active power L2 min	W	√	x	x
6170/7170	7585	R	Active power L2 max	W	√	x	x
6172/7172	7586	R	Active power L3 min	W	√	x	x
6174/7174	7587	R	Active power L3 max	W	√	x	x
6176/7176	7588	R	Reactive power L1 min	var	√	x	√
6178/7178	7589	R	Reactive power L1 max	var	√	x	√
6180/7180	7590	R	Reactive power L2 min	var	√	x	x
6182/7182	7591	R	Reactive power L2 max	var	√	x	x
6184/7184	7592	R	Reactive power L3 min	var	√	x	x
6186/7186	7593	R	Reactive power L3 max	var	√	x	x
6188/7188	7594	R	Apparent power L1 min	VA	√	x	√
6190/7190	7595	R	Apparent power L1 max	VA	√	x	√
6192/7192	7596	R	Apparent power L2 min	VA	√	x	x
6194/7194	7597	R	Apparent power L2 max	VA	√	x	x
6196/7196	7598	R	Apparent power L3 min	VA	√	x	x
6198/7198	7599	R	Apparent power L3 max	VA	√	x	x

6200/7200	7600	R	Powerfactor (PF) of phase L1 min	-	√	x	√
6202/7202	7601	R	Powerfactor (PF) of phase L1 max	-	√	x	√
6204/7204	7602	R	Powerfactor (PF) of phase L2 min	-	√	x	x
6206/7206	7603	R	Powerfactor (PF) of phase L2 max	-	√	x	x
6208/7208	7604	R	Powerfactor (PF) of phase L3 min	-	√	x	x
6210/7210	7605	R	Powerfactor (PF) of phase L3 max	-	√	x	x
6212/7212	7606	R	tg φ factor of phase L1 min	-	√	x	√
6214/7214	7607	R	tg φ factor of phase L1 max	-	√	x	√
6216/7216	7608	R	tg φ factor of phase L2 min	-	√	x	x
6218/7218	7609	R	tg φ factor of phase L2 max	-	√	x	x
6220/7220	7610	R	tg φ factor of phase L3 min	-	√	x	x
6222/7222	7611	R	tg φ factor of phase L3 max	-	√	x	x
6224/7224	7612	R	Phase-to-phase voltage L1-2 min	V	√	√	x
6226/7226	7613	R	Phase-to-phase voltage L1-2 max	V	√	√	x
6228/7228	7614	R	Phase-to-phase voltage L2-3 min	V	√	√	x
6230/7230	7615	R	Phase-to-phase voltage L2-3 max	V	√	√	x
6232/7232	7616	R	Phase-to-phase voltage L3-1 min	V	√	√	x
6234/7234	7617	R	Phase-to-phase voltage L3-1 max	V	√	√	x
6236/7236	7618	R	3-phase mean voltage min	V	√	√	x
6238/7238	7619	R	3-phase mean voltage max	V	√	√	x
6240/7240	7620	R	3-phase mean current min	A	√	√	x

6242/7242	7621	R	3-phase mean current max	A	√	√	x
6244/7244	7622	R	3-phase active power min	W	√	√	x
6246/7246	7623	R	3-phase active power max	W	√	√	x
6248/7248	7624	R	3-phase reactive power min	var	√	√	x
6250/7250	7625	R	3-phase reactive power max	var	√	√	x
6252/7252	7626	R	3-phase apparent power min	VA	√	√	x
6254/7254	7627	R	3-phase apparent power max	VA	√	√	x
6256/7256	7628	R	mean power factor (PF) min	-	√	√	x
6258/7258	7629	R	mean power factor (PF) max	-	√	√	x
6260/7260	7630	R	Mean Tgφ factor min	-	√	√	x
6262/7262	7631	R	Mean Tgφ factor max	-	√	√	x
6264/7264	7632	R	Frequency min	Hz	√	√	√
6266/7266	7633	R	Frequency max	Hz	√	√	√
6268/7268	7634	R	Mean phase-to-phase voltage min	V	√	√	x
6270/7270	7635	R	Mean phase-to-phase voltage max	V	√	√	x
6272/7272	7636	R	3-phase active power 15,30,60 minutes min	W	√	√	√
6274/7274	7637	R	3-phase active power 15,30,60 minutes max	W	√	√	√
6276/7276	7638	R	THD U1 min	V / %	√	x	√
6278/7278	7639	R	THD U1 max	V / %	√	x	√
6280/7280	7640	R	THD U2 min	V / %	√	x	x
6282/7282	7641	R	THD U2 max	V / %	√	x	x
6284/7284	7642	R	THD U3 min	V / %	√	x	x

6286/7286	7643	R	THD U3 max	V / %	√	x	x
6288/7288	7644	R	mean THD U min	V / %	√	x	x
6290/7290	7645	R	mean THD U max	V / %	√	x	x
6292/7292	7646	R	THD I1 min	A / %	√	x	√
6294/7294	7647	R	THD I1 max	A / %	√	x	√
6296/7296	7648	R	THD I2 min	A / %	√	x	x
6298/7298	7649	R	THD I2 max	A / %	√	x	x
6300/7300	7650	R	THD I3 min	A / %	√	x	x
6302/7302	7651	R	THD I3 max	A / %	√	x	x
6304/7304	7652	R	mean THD I min	A / %	√	x	x
6306/7306	7653	R	mean THD I max	A / %	√	x	x
6308/7308	7654	R	cosinus of angle between U1 and I1 min	-	√	x	√
6310/7310	7655	R	cosinus of angle between U1 and I1 max		√	x	√
6312/7312	7656	R	cosinus of angle between U2 and I2 min	-	√	x	x
6314/7314	7657	R	cosinus of angle between U2 and I2 max	-	√	x	x
6316/7316	7658	R	cosinus of angle between U3 and I3 min	-	√	x	x
6318/7318	7659	R	cosinus of angle between U3 and I3 max	-	√	x	x
6320/7320	7660	R	3-phase mean cosinus min	-	√	√	x
6322/7322	7661	R	3-phase mean cosinus max	-	√	√	x
6324/7324	7662	R	Angle between U1 and I1 min	°	√	x	√

6326/7326	7663	R	Angle between U1 and I1 max	°	√	x	√
6328/7328	7664	R	Angle between U2 and I2 min	°	√	x	x
6330/7330	7665	R	Angle between U2 and I2 max	°	√	x	x
6332/7332	7666	R	Angle between U3 and I3 min	°	√	x	x
6334/7334	7667	R	Angle between U3 and I3 max	°	√	x	x
6336/7336	7668	R	current in neutral conductor min	A	√	x	x
6338/7338	7669	R	current in neutral conductor max	A	√	x	x

In case of a lower exceeding the value $-1e20$ is written in, however after an upper exceeding or error occurrence, the value $1e20$ is written.

9. ERROR CODES

During the meter operation, messages about errors can occur. Reasons of errors are presented below.

Err1 -when the voltage or current is too small when measuring:

- PFi, $\text{tg}\phi$, cos, THD below 10% U_n ,
- PFi, $\text{tg}\phi$, cos, below 1% I_n ,
- THD below 10% I_n ,
- f below 10% U_n ,
- $I_{(N)}$, below 10% I_n ;

bAd Freq - When measuring harmonics and THD, if the frequency value is beyond the interval 48 – 52 Hz for 50Hz and 58 – 62 for 60 Hz;

Err CAL, Err EE - are displayed when the meter memory is damaged. The meter must be sent to the manufacturer.

Err PAr - are displayed when operating parameters in the meter are incorrect. One must restore manufacturer's parameters (from the menu level or through RS-485). One can disable the message by the  push-button.

Err Enrg - are displayed when energy values in the meter are incorrect. One can disable the message by the  push-button. Incorrect energy values are reset.

Err L2 L3 error of phase sequence, one must interchange the connection of phase 2 and phase 3. One can disable the message by the  push-button. Each time you power up, the message will be displayed again.

-----or----- - lower overflow. The measured value is smaller than the lower measuring quantity range.

----- or ----- - upper overflow. The measured value is higher than the upper measuring quantity range or measurement error.

10. TECHNICAL DATA

Measuring ranges and admissible basic errors

Table 11

Measured value	Indication range*	Measuring range	L1	L2	L3	Σ	Basic error
Current In 1 A 5 A	0.00 ... 12 kA 0.00 ... 60 kA	0.002 ... 1.200 A~ 0.010 ... 6.000 A~	•	•	•		±0.2% r
Voltage L-N 57.7 V 230 V	0.0 ... 280 kV 0.0 ... 1.104 MV	2.8 ... 70.0 V~ 11.5 ... 276 V~	•	•	•		±0.2% r
Voltage L-L 100 V 400 V	0.0 ... 480 kV 0.0 ... 1.92 MV	5 ... 120 V~ 20 ... 480 V~	•	•	•		±0.5% r
Frequency	47.0 .. 63.0 Hz	47.0...63.0 Hz	•	•	•		±0.2%mv
Active power	-9999 MW .. 0.00 W .. 9999 MW	-1.65 kW...1.4 W...1.65 kW	•	•	•	•	±0.5% r
Reactive power	-9999 Mvar .. 0.00 var ... 9999 Mvar	-1.65 kvar...1.4 var...1.65 kvar	•	•	•	•	±0.5% r
Apparent power	0.00 VA .. 9999 MVA	1.4 VA...1.65 kVA	•	•	•	•	±0.5% r
Power factor PF	-1 .. 0.. 1	-1...0...1	•	•	•	•	±1% r
Tangent φ factor	-10.2...0...10.2	-1.2...0...1.2	•	•	•	•	±1% r
Cosinus φ	-1... 1	-1... 1	•	•	•	•	±1% r
φ	-180 ... 180	-180 ... 180	•	•	•		±0.5% r
Imported active energy	0 .. 99 999 999.9 kWh					•	±0.5% r
Exported active energy	0 .. 99 999 999.9 kWh					•	±0.5% r
Reactive inductive energy	0 .. 99 999 999.9 kvarh					•	±0.5% r
Reactive capacitive energy	0 .. 99 999 999.9 kvarh					•	±0.5% r
Apparent energy	0 ..99 999 999.9 kVAh					•	±0.5% r
THD	0 .. 100%	0 .. 100%	•	•	•		±5% r

* Depending on the set tr_U ratio (ratio of the voltage transformer: 0.1...4000.0) and tr_I ratio (ratio of the current transformer: 1...10000)

r - of the range

mv - of the measured value

Caution! For the correct current measurement the presence of a voltage higher than 0.05 Un is required at least in one of the phase

Power input:	
- in supply circuit	$\leq 6 \text{ VA}$
- in voltage circuit	$\leq 0.05 \text{ VA}$
- in current circuit	$\leq 0.05 \text{ VA}$
Display field:	dedicated display LCD 3.5"
Relay output:	relay, voltageless NO contacts load capacity 250 V~/0.5 A ~
Serial interface RS-485:	address 1...247; mode: 8N2,8E1, 8O1,8N1; baud rate: 4.8, 9.6, 19.2, 38.4 kbit/s transmission protocol: Modbus RTU response time: 600 ms
Energy impulse output	output of OC type (NPN), passive of class A, acc.to EN 62053-31 supply voltage 18 .. 27 V, current 10 .. 27 mA
Constant of OC type output impulse:	1000 - 20000 imp./kWh independently of set tr_U, tr_I ratios
Protection grade ensured by the casing:	
- from frontal side	IP 65
- from terminal side	IP 20
Weight	0.3 kg
Overall dimensions	96 x 96 x 77 mm

Reference and rated operating conditions

- supply voltage	85...253 V a.c. (40...400) Hz or 90...300 V d.c. 20..40 V a.c. (40...400) Hz or 20..60 V d.c.
- input signal:	0... <u>0.002...1.2</u> I_n ; <u>0.05...1.2</u> U_n for current, voltage 0... <u>0.002...1.2</u> I_n ; 0... <u>0.1...1.2</u> U_n for power factors Pf_i , $t\phi_i$ frequency <u>47...63</u> Hz sinusoidal (THD $\leq 8\%$)
- power factor	-1...0...1
- ambient temperature	-25... <u>23</u> ...+55°C
- storage temperature	-30...+70°C
- relative humidity	25...95% (condensation inadmissible)
- admissible peak factor:	
- current intensity	2
- voltage	2
- external magnetic field	<u>0...40</u> ...400 A/m
- short duration overload (5 s)	
- voltage inputs	2 U_n (max. 1000 V)
- current inputs	10 I_n
- operating position	any
- preheating time	5 min.

Additional errors:

in % of the basic error

- from frequency of input signals	< 50%
- from ambient temperature changes	< 50%/10°C
- for THD > 8%	< 100%

Standards fulfilled by the meter:

Electromagnetic compatibility:

- noise immunity acc. to EN 61000-6-2
- noise emissions acc. to EN 61000-6-4

Safety requirements:

according to EN 61010 -1 standard

- isolation between circuits: basic
- installation category: III
- pollution level: 2
- maximum phase-to-earth voltage:
 - for supply and measuring circuits 300 V
 - for remaining circuits 50 V
- altitude above sea level: < 2000 m.

11. ORDERING CODES

Table 12

Meter of network parameters ND20L -	X	X	X	XX	X	X
Current input In:						
1 A (X/1)	1					
5 A (X/5)	2					
Voltage input (phase/phase-to-phase) Un:						
3 x 57.7/100 V	1					
3 x 230/400 V	2					
Supply voltage:						
85..253 V a.c., 90..300 V d.c.				1		
20..40 V a.c., 20..60 V d.c.				2		
Kind of version:						
standard				00		
custom-made*				XX		
Language:						
Spanish					S	
English					E	
French					F	
Acceptance tests:						
without extra quality requirements						0
with an extra quality inspection certificate						1
acc. to customer's requirements						X

* - After agreeing with the manufacturer.

Example of Order:

When ordering please respect successive code numbers.

The code: **ND20L- 2-2--1- 00- E-1** means:

ND20L – meter of network parameters of ND20LITE type

2 – current input In : 5 A (x/5),

2 – input voltage (phase/phase-to-phase) Un = 3 x 230/400 V,

1 – supply voltage: 85...253 V a.c., 90..300 V d.c.

00 – standard version

E – all descriptions and user's manual in English,

1 – with an extra quality inspection certificate.



MT-ND20LITE_EN_140717

DISEÑOS Y TECNOLOGIA S.A.

Xarol, 6B P.I. Les Guixeres
08915 Badalona - ESPAÑA
tel.: +34 933 394 758, fax +34 934 903 145
www.ditel.es

made in POLAND by:
LUMEL S.A.
www.lumel.com.pl

30722003B