

SYROS

SY24 – SY48 – SY49 – SY96 MODELS



INSTRUCTIONS MANUAL

SYROS

SY24 – SY48 – SY49 – SY96

Thank you for your purchasing this Digital Temperature Controller. Please check that the product is exactly the one you ordered and use it according to the following instructions. (Please refer to a separate operation manual for details.) Dealers are cordially requested to ensure the delivery of this Instruction Manual to hands of the end-users.

NOTICE

The contents of this document may be changed in the future without prior notice.

We paid the utmost care for the accuracy of the contents. However, we are not liable for direct and indirect damages resulting from incorrect descriptions, omission of information, and use of information in this document.

INDEX

Index	1
Check Of specifications and accessories	2
Safety precautions	2
Index	8
1. Installation/mounting.....	9
2. Wiring	12
3. Usage.....	15
4. Display and operation	17
5. Setting methods of temperature and parameters	19
Model SY24	19
Models SY48, SY49 y SY96.....	22
6. Functions.....	26
6-1 Control ON/OFF.....	26
6-2 Auto-tuning	27
6-3 Self-tuning.....	28
6-4 alarm function [option]	30
6-5 Ramp/soak function [option]	33
6-6 Communication function [option]	34
6-7 Digital input (DI function) [option].....	35
6-8 Other function	36
6-9 Retransmission function	37
6-10 Remote SV function	38
7. Setting of input type and control algorithm	39
8. Error indications	41
SY24 model	
[Table 1] Input type code	42
[Table 2] Input Range (standard range).....	42
[Table 3] Alarm action type code.....	43
[Table 4] Control output action mode code.....	44
Specification	45
SY48, SY49 y SY96 models	
[Table 1] Input type code	46
[Table 2] Control output action mode code.....	46
[Table 3] Input Range (standard range).....	47
[Table 4] Alarm action type code.....	48
[Table 5] Control operation type code.....	49
Specification	50
SYROS models code configuration	51
Warranty and CE conformity	52



CHECK OF SPECIFICATIONS AND ACCESSORIES

Before using the controller, check if the type and specifications are as ordered.
 (A table of Model code configuration is given in Page 37).
 Check that all of the following accessories are included in the package box.

Temperature controller	1 unit
Instruction manual	1 copy
Mounting mixtures	1 pc.
I/V unit (250. resistor)	1 pc. (4-20mA DC input type only)
Watertight packing	1 pc.

SAFETY PRECAUTIONS

Before using this product, the user is requested to read the following precautions carefully to ensure the safety. Safety precautions must be taken by every user to prevent accidents.
 The safety requirements are classified into "Warning" and "Caution" according to the following interpretations
 :

 Warning	Suggesting that the user's mishandling can result in personal death or serious injury.
 Caution	Suggesting that the user's mishandling can result in personal injury or damage to the property.



Warning

Over-temperature Protection

"Any control system design should take into account that any part of the system has the potential to fail".
 "For temperature control systems, continued heating should be considered the most dangerous condition, and the machine should be designed to automatically stop heating if unregulated due to the failure of the control unit or for any other reason".

The following are the most likely causes of unwanted continued heating:

- 1) Controller failure with heating output constantly on
- 2) Disengagement of the temperature sensor from the system
- 3) A short circuit in the thermocouple wiring
- 4) A valve or switch contact point outside the system is locked to keep the heat switched on.

In any application where physical injury or destruction of equipment might occur, we recommend the installation

of independent safety equipment, with a separate temperature sensor, to disable the heating circuit in case of overheating.

The controller alarm signal is not designed to function as a protective measure in case of controller failure.

1. Warning

1.1 Installation and wiring

This controller designed to be installed at the following conditions.

Operating temperature	-10 a +50 [°C]	
Operating humidity	90% RH or less (non condensation)	
Installation category	II	Conforming to IEC1010-1
Pollution degree	2	

The controller must be installed such that with the exception of the connection to the mains, creepage and clearance distances shown in the table below are maintained between the temperature probe and any other assemblies which use or generate a voltage shown in the table below. Failure to maintain these minimum distances would invalidate the EN 61010 safety approval.

Voltage used or generated by any assemblies	Clearance (mm)	Creepage (mm)
Up to 50Vrms or Vdc	0,2	1,2
Up to 100Vrms or Vdc	0,2	1,4
Up to 150Vrms or Vdc	0,5	1,6
Up to 300Vrms or Vdc	1,5	3,0
Above de 300Vrms or Vdc	Contact with our sales office.	

If the voltage shown above exceeds 50Vdc (i.e. hazardous voltage), the basic insulation is required between all terminals of this controller and the ground, and supplementary insulation is required for the alarm output.

Isolation class of this controller is as shown below. Be sure to check that the isolation class of the controller satisfies your requirements before installation.

————— : Basic insulation - - - - - : Non-insulation ————— : Functional insulation

Mains (Power source)	Measured value input, CT input, Remote SV input
Control output1 (relay output)	Internal circuit
Control output2 (relay output)	Control output1, 2 (SSR drive output / Current output)
Alarm outout (AL1)	Re-transmission
Alarm outout (AL2)	Communication (RS-485) circuit
Alarm outout (AL3) or Heater burnout alarm output (HB)	Digital input (DI).

- If there is a danger of a serious accident resulting from a failure or a defect in this unit, provide the unit with an appropriate external protective circuit to prevent an accident.
- The unit is normally supplied without a power switch and fuses.

Make wiring so that the fuse is placed between the main power supply switch and this controller.

(Main power supply: 2 pole breaker, fuse rating: 250V, 1A)

- When wiring the power supply terminal, use vinyl insulated 600 volt cable or equivalent.
- To avoid the damage and failure of controller, supply the power voltage fitting to the rating.
- To avoid an electric shock and controller failure, do not turn ON the power before all wiring is completed.
- Be sure to check that the distance is kept to avoid electric shock or firing before turning the power ON.
- Keep away from terminals while the circuit is energized in order to avoid an electric shock and a malfunction.
- Never attempt to disassemble, fabricate, modify, or repair this unit because tampering with the unit may result in a malfunction, electric shock, or a fire.

1.2 Maintenance precautions

- Be sure to turn off the power before this controller is installed or removed in order to avoid an electric shock, malfunction, and fault.
 - Regular maintenance is recommended a longer service life of this controller.
- Some parts of this controller have a limited life span, or they will be deteriorated with the lapse of time.
- One-year warranty is guaranteed for this unit including accessories, provided that the controller is properly used.

2. Caution

2.1 Cautions on installation

Avoid the following places for installation.

- a place where the ambient temperature may reach beyond the range of from 0 to 50°C while in operation.
- a place where the ambient humidity may reach beyond the range of from 45 to 85% RH while in operation.
- a place where a change in the ambient temperature is so rapid as to cause condensation.
- a place where corrosive gases (sulfide gas and ammonia gas, in particular) or combustible gases are emitted.
- a place where the unit is subject directly to vibration or shock.
(Vibration or shock may cause output relay malfunction.)
- a place exposed to water, oil, chemicals, steam and vapor.
(if immersed with water, take the inspection by sales office to avoid an electrical leakage and firing)
- a place where the unit is exposed to dust, salt air, or air containing iron particles.
- a place where the unit is subject to interference with static electricity, magnetism, and noise.
- a place where the unit is exposed to direct sunlight.
- a place where the heat may be accumulated due to the radiation of heat.

2.2 Caution on installation on panel

SY24 – SY48 MODELS

- Insert the mounting bracket (accessory) from the rear side until the main unit is securely fit into the panel. If there should be a play, tighten two screws lightly until the play is eliminated. (Do not tighten the screws excessively because the mounting bracket can be removed from the stopper by the force.)

Fig1 y Fig2

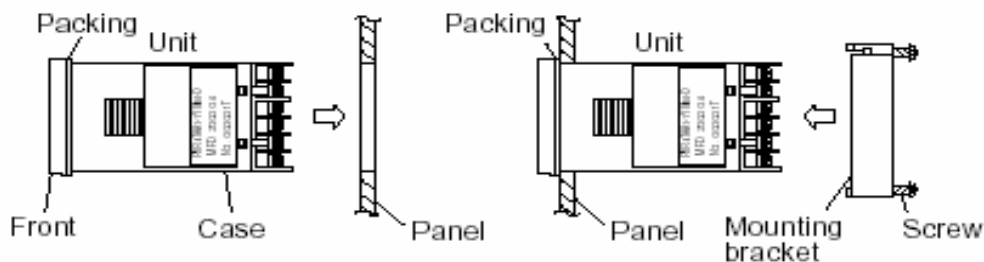

Figure 1

Figure 2

SY49 – SY96 MODELS

- Attach the supplied fixtures (2 pcs.) to PXR5/9 at the top and the bottom, and fasten them using a screwdriver. The fastening torque should be approximately 0.15N·m (1.5kg·cm). If the plastic fixture is fastened at excessive torque, it is split horizontally around the center, thus allowing the torque to be released. If a split appears around the center, there is no problem with the use of the instrument. (The case is made of plastic. Therefore, be careful not to fasten them excessively). In the case of PXR9, place the mounting fixture into the mounting hole at the center of the main body. Fig 3 y Fig 4

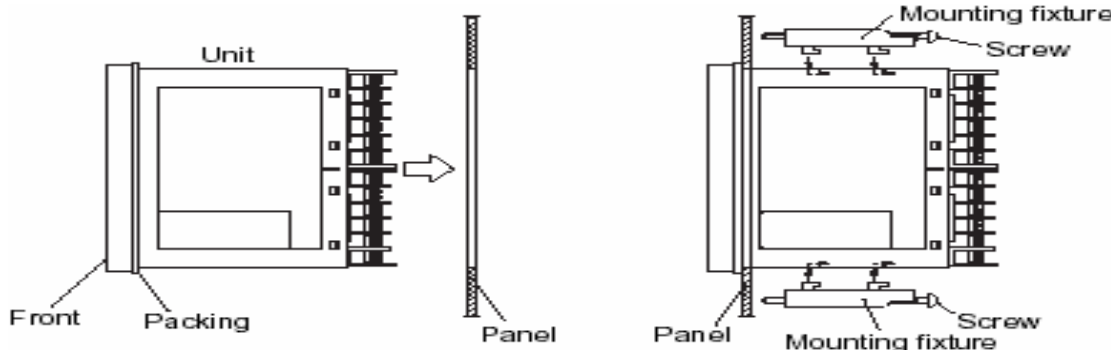

Fig. 3

Fig. 4

• The front side of this controller conforms to NEMA 4X (equivalent with IP66). To ensure the waterproofness between the instrument and the panel, use packings that are provided as accessories in the following manner: (The improper fitting of packings will ruin the waterproofness.)

- 1 As shown in Figure 1, fit a packing to the case of the unit and then insert it in the panel.
- 2 Tighten screws on the fixing frame or fixtures so that no gaps are given between the front of controller and packing and between panels. Check that there are no deviation and deformation of packing as shown in Fig. 5.

If panel strength is weak, it may cause a gap between the packing and the panel, thus impairing water resistance.

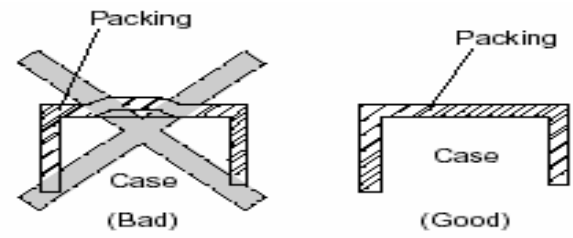
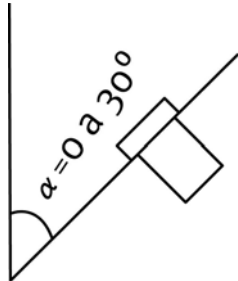

Fig. 5

Standard : Vertical mounting, flush on the panel. (The controller is horizontal.)
When mounting the controller on tilted surface, the maximum tilt angle is 30° (degree) from vertical.



- (Caution)**
- Don't block the openings around the controller, or radiation effect will be reduced.
 - Don't block the ventilation openings at the top of the terminal block.

2.3 Precautions in wiring connections

- For the thermocouple sensor type, use thermocouple compensation wires for wiring.
For the RTD type, use a wiring material with a small lead wire resistance and no resistance differentials among three wires.

- Keep input lines away from power line and load line to avoid the influence from noise induced.
- For the input and output signal lines, be sure to use shielded wires and keep them away from each other.
- If a noise level is excessive in the power supply, the additional installation of an insulating transformer and the use of a noise filter are recommended.

(example: ZMB22R5-11 Noise Filter manufactured by TDK)

Make sure that the noise filter is installed to a place such as a panel that is properly grounded. The wiring between the noise filter output terminal and the instrument power supply terminal should be made as short as possible. None of fuses or switches should be installed to the wiring on the noise filter output side because the filter effect will be degraded by such an installation.

- A better anti-noise effect can be expected by using stranded power supply cable for the instrument. (The shorter the stranding pitch is, the better the anti-noise effect can be expected.)

- For the unit with an alarm against a failure (burn-out) in the heater, use the same power line for connection of the power supplies for the heater and the controller.

- A setup time is required for the contact output when the power is turned on. If the contact output is used as a signal for an external interlock circuit, use a delay relay at the same time.

- Use the auxiliary relay since the life is shortened if full capacity load is connected to the output relay. SSR/SSC drive output type is preferred if the output operations occur frequently.

[Proportional interval] relay output: 30 seconds or more,

SSR/SSC: one second or more

- If inductive load such as magnetic switches connected as a relay output load, it is recommended to use Z-Trap manufactured by Fuji Electric to protect a contact from switching surge and keep a longer life.

power supply voltage: 100 V)---> Z-trap 240V Ø 5mm

power supply voltage: 200 V ---> Z-trap 470V Ø 5mm

Where to install : Connect it between contacts of the relay control output.

Example: Z-Trap connection

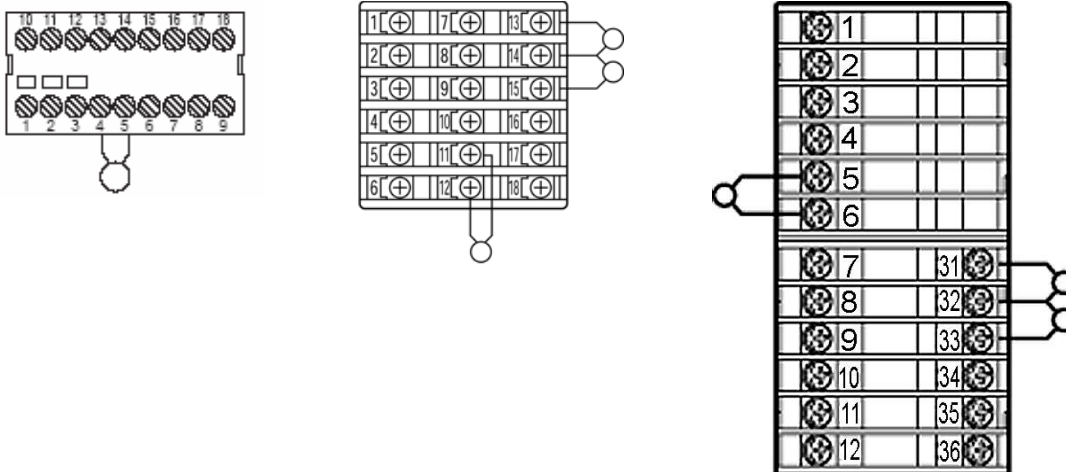

2.4 Requirements for key operation/operation in abnormalities

- Prior to the operation, be sure to check alarm functions, since a failure in the proper setting will result in a failure in the proper output of an alarm in case of an abnormality.
- A display of UUUU or LLLL will appear in case of a break in the input. Be sure to turn off the power when a sensor is replaced.

2.5 Others

- Do not use organic solvents such as alcohol and benzene to wipe this controller. Use a neutral detergent for wiping the controller.

Index

< REFERENCE ITEMS>	<DESCRIPTION>
Confirming type specification	<ul style="list-style-type: none"> • Confirming that the delivered controller is equal to the ordered one.
1. Installation/mounting	<ul style="list-style-type: none"> • Outline dimensions • Panel cutout dimensions • Mounting method on the panel
2. Wiring	<ul style="list-style-type: none"> • Terminal connection diagram
Power on	
*Note	
3. Usages 4. Display and operation 5 Setting method of temperature and parameters 6. Functions	<ul style="list-style-type: none"> • Set value change method • Basic operation method • List of parameters • List of input/output/alarm codes
7. Setting of input type and control algorithm.	<ul style="list-style-type: none"> • Setting of input type and ranges • Selecting of control method
Operation	
8. Error indications	

(Note) *To start the operation, wait for about 30 minutes after the power-on for warm up.

1 Installation/mounting

SY24

Controller outline dimensions (unit:mm)

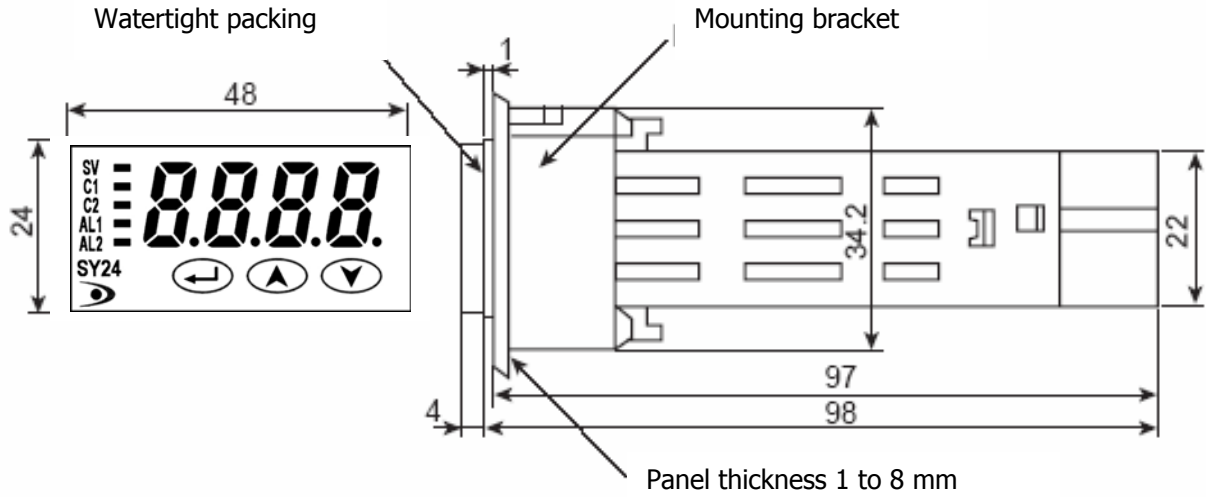

Panel cutout dimensions (unit:mm)

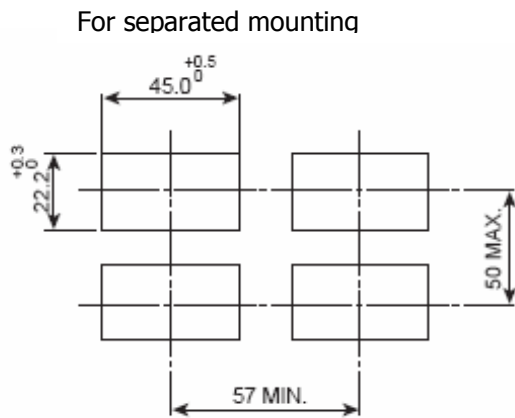

For mounting close together (n controllers)

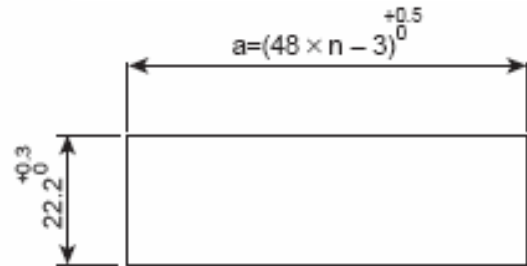

Number of units	2	3	4	5	6
a	93	141	189	237	285

Note:

- Watertight feature is unavailable if mounted close together.
- Maximum ambient temperature is 45°C if mounted close together.

SY48

Controller outline dimensions (unit:mm)

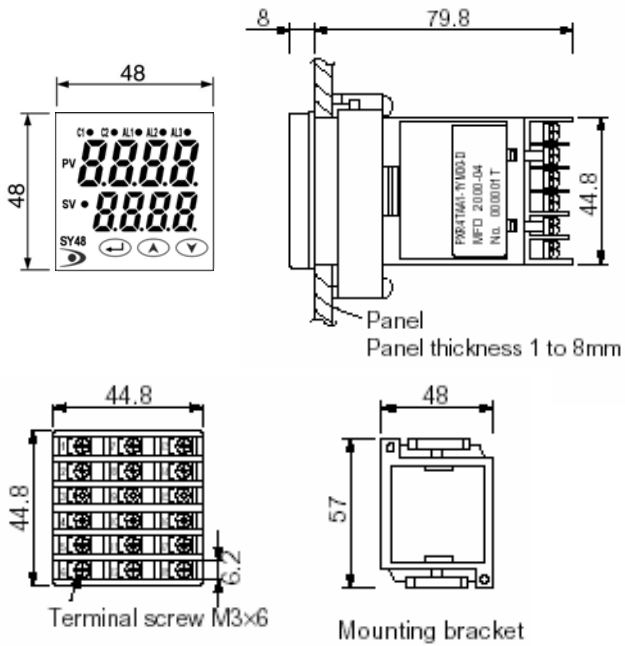

Panel cutout dimensions (unit:mm)

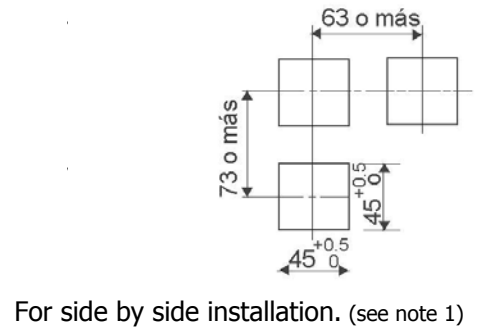

For side by side installation. (see note 1)

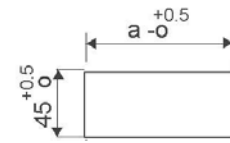

Number of units	2	3	4	5	6
a	93	141	189	237	285

Note 1

With the power supply of 200 VAC or more, a maximum ambient temperature is 45°C. (It is recommended to use a fan for cooling.)

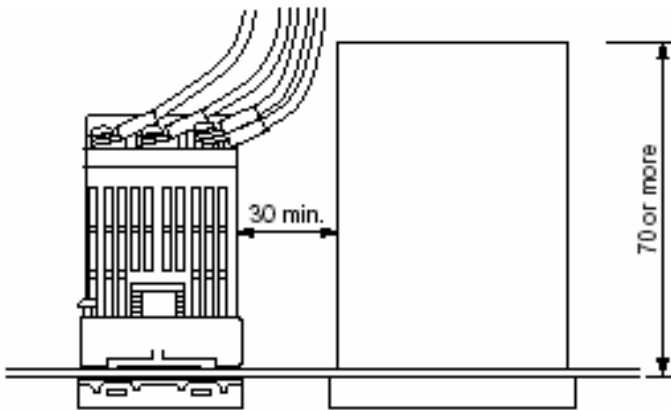

When there is another instrument (larger than 70mm) or a wall on the right side of this controller, be sure to install the controller keeping a space of more than 30mm. Waterproofness cannot be ensured in the case of side-by-side installation.

Cautions on wiring

- Wiring should be started from the left side terminal (No. 1 to No. 6).
- Use crimped terminals matched to the screw size. Tightening torque should be about 0.8 Nm (Since the case is made of plastic, do not tighten excessively).
- Do not connect anything to terminals not used.

SY49 – SY96

Controller outline dimensions (unit:mm)

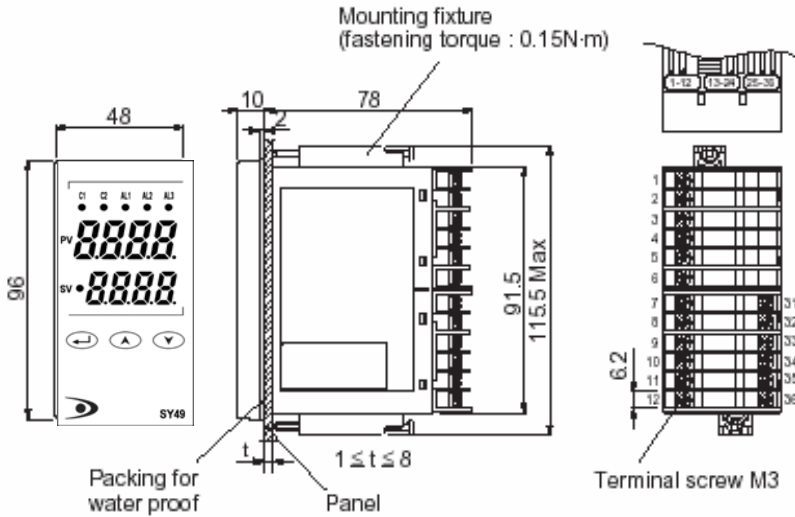

Panel cutout dimensions (unit:mm)

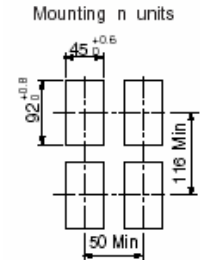

Horizontal close-fit mounting
(see note)

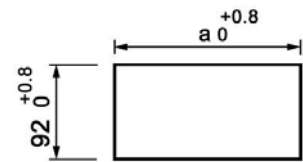

Number of units	2	3	4	5	6
a	93	141	189	237	285

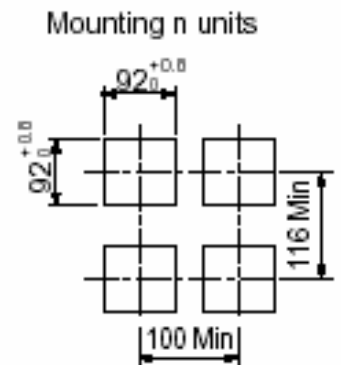
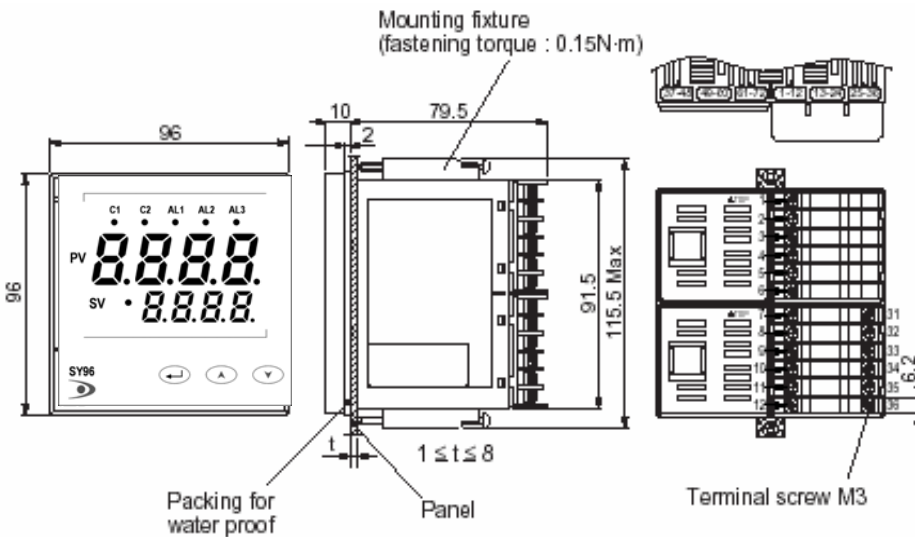

Note) Water proof is impossible in case of horizontal close-fit mounting. Panel cutout dimensions should also satisfy the above values after the panel is coated.

Cautions on close-fit mounting

- With the power supply of 200 VAC or more, a maximum ambient temperature is 45°C. (It is recommended to use a fan for cooling.)
- When there is another instrument (larger than 70mm) or a wall on the right side of this controller, be sure to install the controller keeping a space of more than 30mm.

Cautions on wiring

- Wiring should be started from the left side terminal (No. 1 to No. 12).
- Use crimped terminals matched to the screw size. Tightening torque should be 0.8 Nm.
- Do not connect anything to terminals not used.

2 Wiring

Terminal connection diagram (100 to 240 VAC) or (24 VDC/24 VAC)

SY24

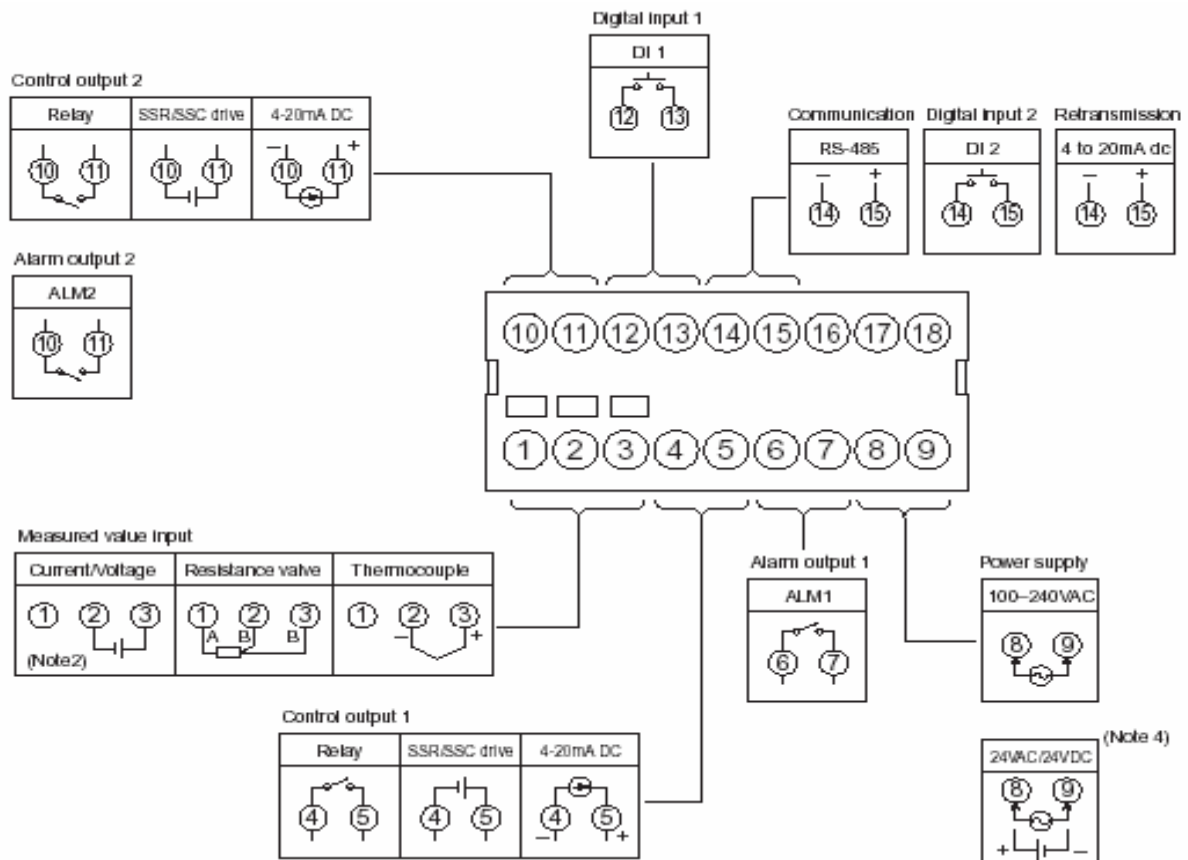

- Note1) Check the power supply voltage before installation.
- Note2) Connect the I/V unit (250Ω resistor) (accessory) between the terminal ② and ③ in case of current input.
- Note3) Tighten the terminal screw securely with fastening torque of 0.4N·m.
- Note4) When the 10th digit of the code symbol is "C", "A", or "B", connect the power according to the connection diagram of 24VAC/24VDC power supply. Input of power of 30VAC/30VDC or more will damage the instrument.

Designation of Wiring Material

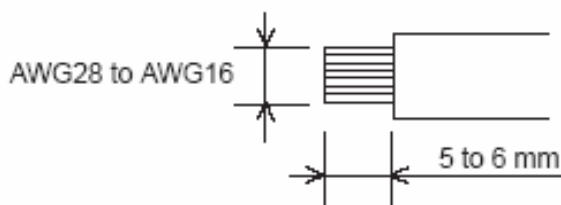

CAUTION: To prevent disconnection or short circuit, never use the wire other than the one stated above, and make sure to insert it toward the recess of the terminal block. Fastening torque: 0.4N·m

Terminal connection diagram (100 to 240 VAC, 24V AC/24V DC)

SY48

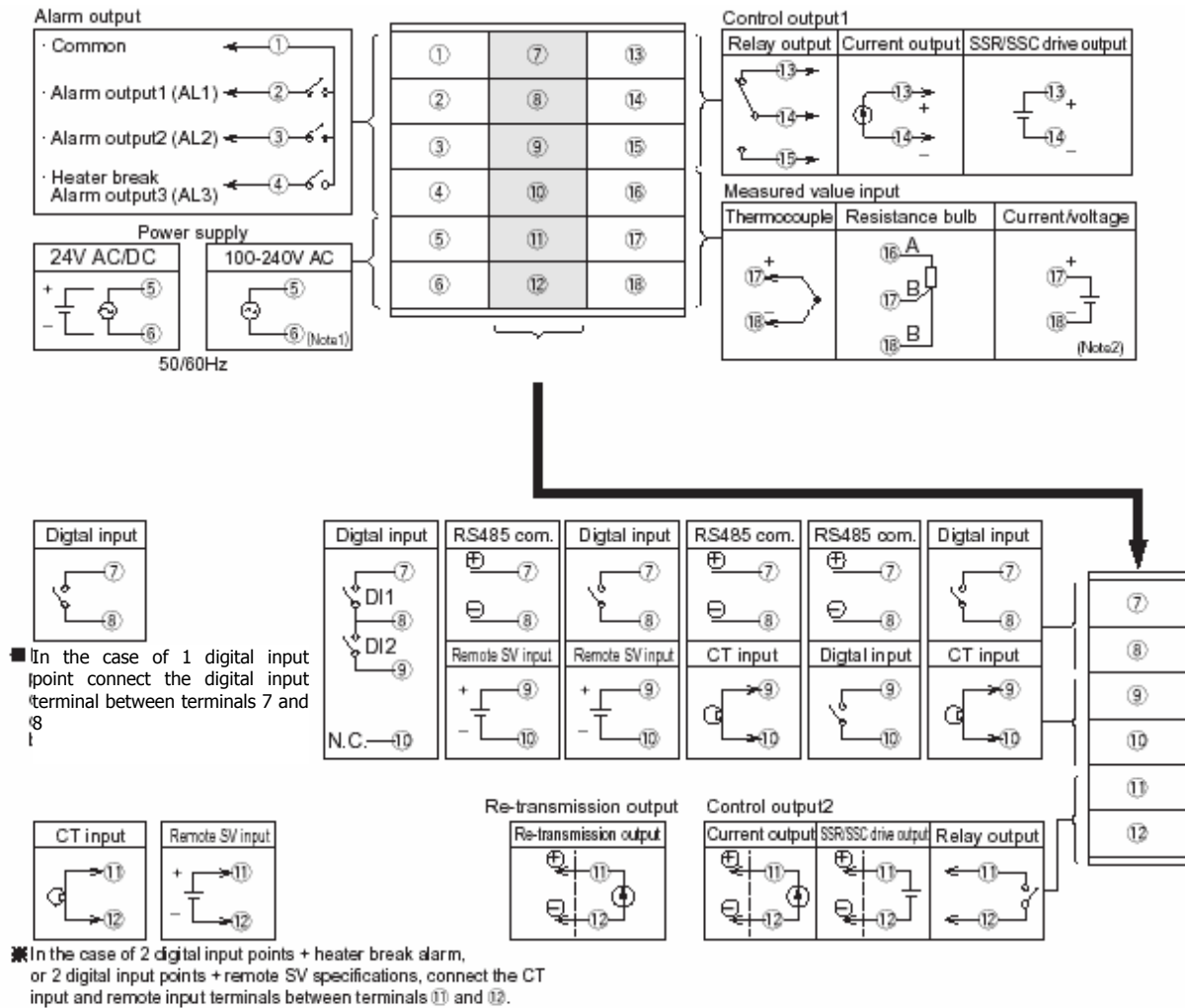

Note 1) Check the power supply voltage before installation.

Note 2) Connect the 250 Ω resistor (accessory) between the terminal 17 and 18 in case of current

Terminal connection diagram (100 to 240 AC, 24V AC/24V DC)

SY49 – SY96

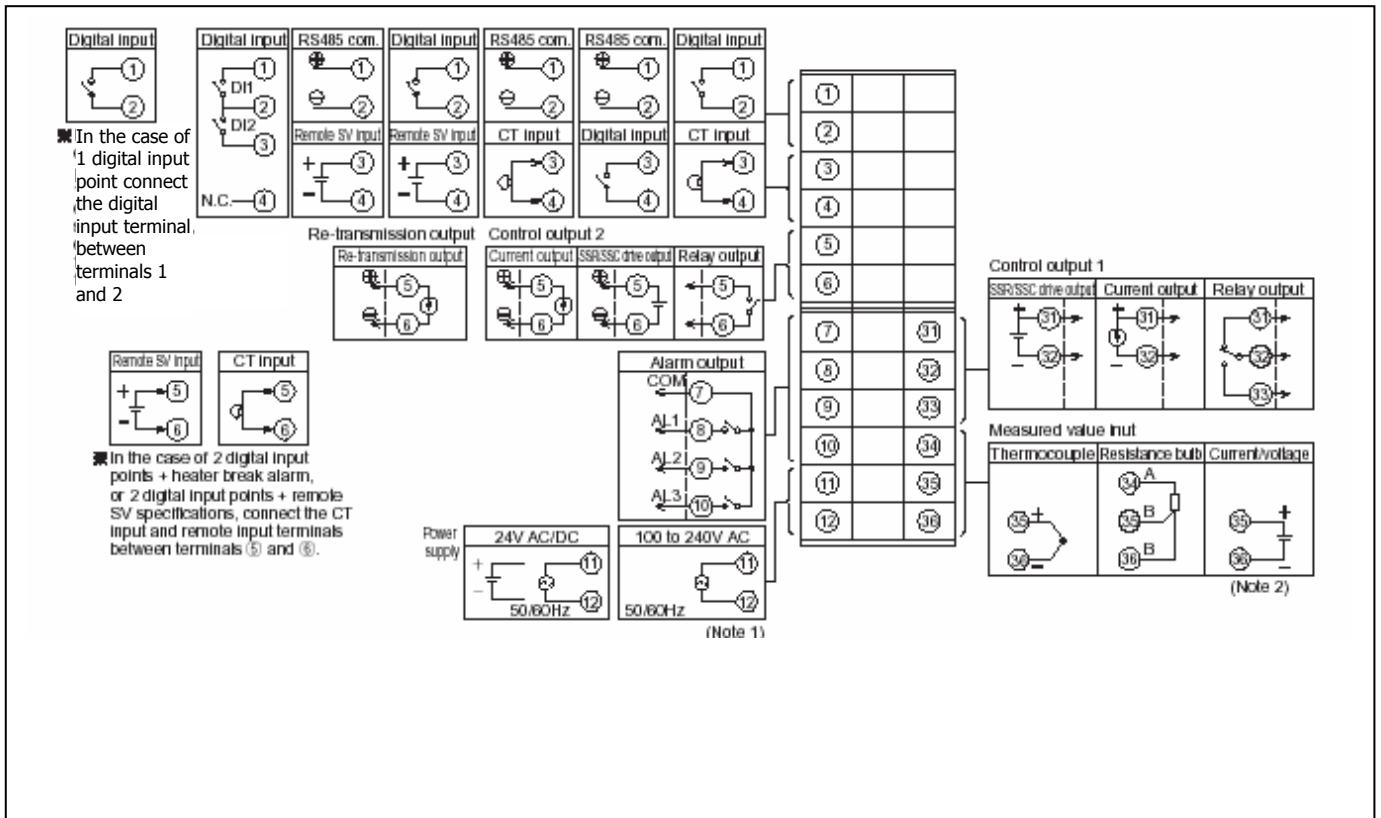

Note 1) Check the power supply voltage before installation.

Note 2) Connect the 250 Ω resistor (accessory) between the terminal 35 and 36 in case of current input.

3 Usage

Name of functional parts and functions SY24

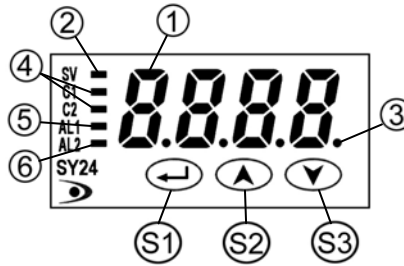

Setting keys

	Name	Function
①	Select key	The key shifting to the 1st, the 2nd or the 3rd block parameter, switching the display between parameter and the data at the 1st, the 2nd and the 3rd block.
②	Up key	<ul style="list-style-type: none"> The numerical value is increased by pressing the key once. The numerical value keeps on increasing by pressing the key continuously. For searching parameters within the 1st, the 2nd and the 3rd block.
③	Down key	<ul style="list-style-type: none"> The numerical value is decreased by pressing the key once. The numerical value keeps on decreasing by pressing the key continuously. For searching parameters within the 1st, the 2nd and the 3rd block.

Display/Indication

	Name	Function
①	Process value (PV)/Set value (SV) /parameter name or parameter setting display	<ol style="list-style-type: none"> Displays a process value or set value at operation mode. Displays the parameter name or settings at parameter setting mode. Displays the various error indications (refer to the "8. Error indications"). Flickers at Standby mode when SV is displayed. Displays the set value (SV) and "SV-x" (x:1 to 4) alternately when the SV-switching function is used and SV is displayed.
②	Set value (SV) indication lamp	<ol style="list-style-type: none"> The lamp is lit while a set value (SV) is displayed. Flickers while the process value (PV) is displayed in Standby mode.
③	Auto-tuning/self-tuning indicator	The lamp flickers while the PID auto-tuning or the self-tuning is being performed.
④	Control output indication lamp	C1 : The lamp is lit while the control output 1 is ON. C2 : The lamp is lit while the control output 2 is ON. (Note 1)
⑤	Alarm output 1 (ALM1) indication lamp (Note 1)	The lamp is lit when the alarm output 1 is activated. It flickers during ON-delay operation.
⑥	Alarm output 2 (ALM2) indication lamp (Note 1)	The lamp is lit when the alarm output 2 is activated. It flickers during ON-delay operation.

Note 1) Control output 2 and alarm function are optional.

Name of functional parts and functions SY48 – SY49 – SY96

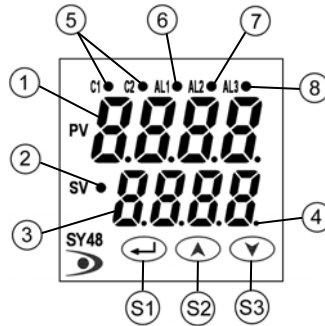

Setting keys

	Name	Function
Ⓢ1	Select key	The key shifting to the 1st, the 2nd or the 3rd block parameter, switching the display between parameter and the data at the 1st, the 2nd and the 3rd block.
Ⓢ2	Up key	<ul style="list-style-type: none"> The numerical value is increased by pressing the key once. The numerical value keeps on increasing by pressing the key continuously. For searching parameters within the 1st, the 2nd and the 3rd block.
Ⓢ3	Down key	<ul style="list-style-type: none"> The numerical value is decreased by pressing the key once. The numerical value keeps on decreasing by pressing the key continuously. For searching parameters within the 1st, the 2nd and the 3rd block.

Display/Indication

	Name	Function
①	Process value (PV)/parameter name display	<ol style="list-style-type: none"> Displays a process value (PV). Displays the parameter symbols at parameter setting mode. Displays various error indications (refer to the "8. Error indications").
②	Set value (SV) indication lamp	The lamp is lit while a set value (SV) is displayed.
③	Set value (SV)/parameter setting display	<ol style="list-style-type: none"> Displays a set value (SV). Displays the parameter settings at parameter setting mode. Flickers at Standby mode. Displays the set value (SV) and "SV-1" alternately when the SV switching function is used. Displays the set value (SV) and "rSV" alternately while in remote operation.
④	Auto-tuning/self-tuning indicator	The lamp flickers while the PID auto-tuning or the self-tuning is being performed.
⑤	Control output indication lamp	<p>C1 : The lamp is lit while the control output 1 is ON.</p> <p>C2 : The lamp is lit while the control output 2 is ON. (Note 1)</p>
⑥	Alarm output 1 (AL1) indication lamp (Note 1)	The lamp is lit when the alarm output 1 is activated. It flickers during ON-delay operation. (Note 2)
⑦	Alarm output 2 (AL2) indication lamp (Note 1)	The lamp is lit when the alarm output 2 is activated. It flickers during ON-delay operation. (Note 2)
⑧	Alarm output 3 (AL3) indication lamp (Note 1)	The lamp is lit while the alarm output 3 or the heater break alarm output is ON. The lamp flickers while in ON delay operation. (Note 2)

Note 1) Control output 2 and alarm function are optional.

Note 2) The lamp does not flicker while the timer is activated.

4 Display and operation

SY24

Standby mode

To perform standby operation, set "STby" as ON in the 1st block parameter.

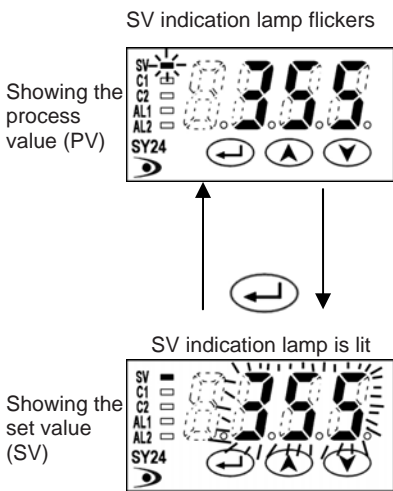

Standby mode:

(Output) Control outputs (1 and 2) and alarm outputs (all) are not provided. However, depending on setting of "P-n1", control action, control outputs are provided at the abnormal input. No alarm output is provided at standby mode, even in (Fault-condition).

Caution Be careful since the equipment does not provide output of the alarm of the main unit abnormality during the standby operation.

(Control) Control is not performed.

(Display) While PV being displayed ; SV indication lamp flickers.

While SV being displayed ; SV display value flickers.

Caution The SV display does not flicker while the 1st, 2nd and 3rd block parameters are displayed.

(Setting) SV and parameter settings are able to perform.

Operation mode

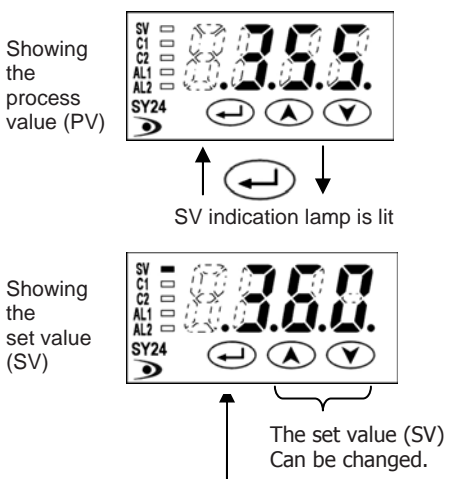

1 Change of set value (SV)

Switching by 1st block STby settings

2 Shift to the 1st, 2nd and 3rd block parameter To shift to the other blocks, press the \leftarrow key.

Caution : Depending on the pressing time of \leftarrow key, you can select the block to shift.

Pressing time \leftarrow	Shifting block
About 1 sec pressing	1st block
About 3 sec pressing	2nd block
About 5 sec pressing	3rd block

Parameters setting mode

Press the \leftarrow for 2 seconds

1 Parameter selection

2 Parameter settings

3 Shift to operation condition

Operation mode

Parameter setting procedure:

1 Select a parameter you want to set by pressing the \uparrow or \downarrow key

2-1 Press the \leftarrow key to display the parameter set value.

2-2 Press the \uparrow or \downarrow key to change the parameter set value.

2-3 After the parameter has been changed, press the \leftarrow key for registration.

3 To shift to Operation/Standby press the \leftarrow key for 2 seconds

4 If unoperated state continues for 30 seconds, it returns to Operation/Standby mode.

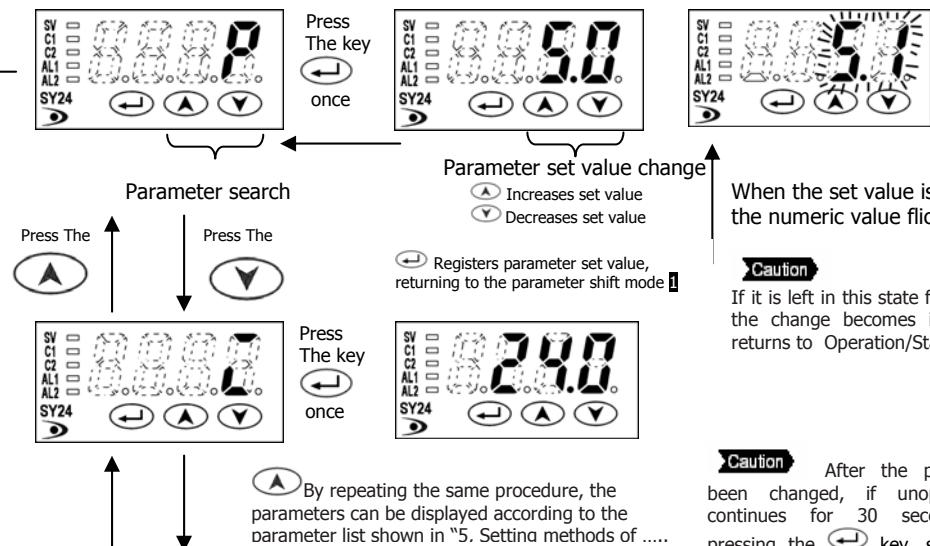

Switching by the \leftarrow key

\uparrow By repeating the same procedure, the parameters can be displayed according to the parameter list shown in "5. Setting methods of

SY48 – SY49 – SY96

Standby mode

To perform standby operation, set "STby" as ON in the 1st block parameter.

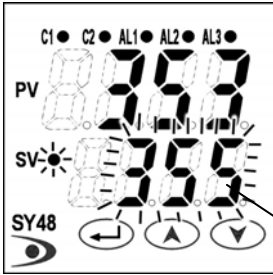

Standby mode:
 (Output) Control outputs (1 and 2) and alarm outputs (all) are not provided. However, depending on setting of "P-n1", control action, control outputs are provided at the abnormal input.
 No alarm output is provided at standby mode, even in (Fault-condition).

Caution Be careful since the equipment does not provide output of the alarm of the main unit abnormality during the standby operation.

(Control) Control is not performed.
 (Display) SV display flickers.

Caution The SV display does not flicker while the 1st, 2nd and 3rd block parameters are displayed.

(Setting) SV and parameter settings are able to perform.

Operation mode

When the SV lamp is lit, the set value (SV) is displayed at the lower line.



The set value (SV) can be changed.

1 Change of set value (SV)

Caution After the data setting, the data are registered automatically in 3 seconds.

2 Shift to the 1st, 2nd and 3rd block parameter

To shift to the other blocks, press the key

Caution Depending on the pressing time of key, you can select the block to shift.

Pressing time	Shifting block
About 1 sec pressing	1st block
About 3 sec pressing	2nd block
About 5 sec pressing	3rd block

Switching by 1st block STby settings

Parameters setting mode

Press the for 2 seconds

3 Shift to operation condition

Operation mode

Parameter setting procedure:

1 Select a parameter you want to set by pressing the or

2-1 Press the key to allow the parameter to change (under the changing conditions, the parameter flickers).

2-2 Press the or key to change the parameter set value.

2-3 After the parameter has been changed, press the key for registration.

3 To shift to Operation/Standby press the key for 2 seconds

1 Parameter selection

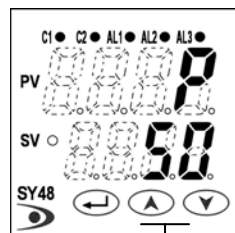

Press The Press The

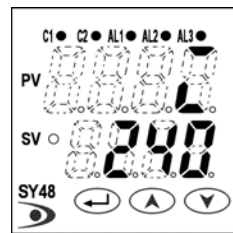

Press the once

2 Parameter settings

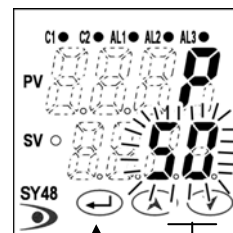

Parameter change

Increases parameter set value

Decreases parameter set value

Register parameter set value, returning to the parameter shift mode **1**

By repeating the same procedure, the parameters can be displayed according to the parameter list shown in "5. Setting methods of temperature and parameters."

Switching by the key

Note: If the upper display (PV) comes off (or kept distinguished), make the setting once again by adding 64 to the set value of parameter DP13.

5 Setting methods of temperature and parameters

SY24

Operation/standby mode

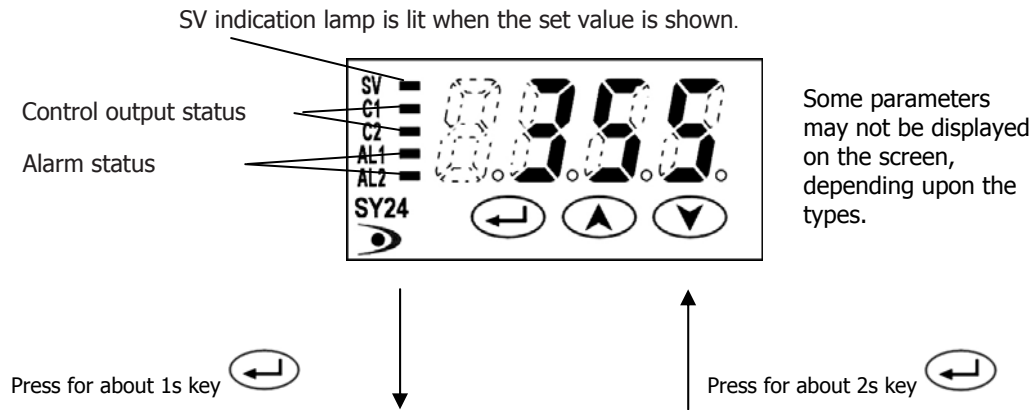

1st block parameter																																												
Parameter display symbol	Parameter	Description of contents	Default setting	Remarks																																								
STbY	STbY	Standby settings	Switches RUN or Standby of the control. ON: Control standby (output: OFF, alarm: OFF) OFF: Control RUN	OFF																																								
ProG	ProG	Ramp/soak control	OFF: stop, rUn: Start, HLd: status hold	OFF																																								
LACH	LACH	Alarm latch cancel	Releases alarm latch. 1: Alarm latch release	0																																								
AT	AT	Auto-tuning	0: Stop, 1: Standard AT start, 2: Low PV type AT start	0																																								
TM-1	TM-1	Timer 1 display	Time display indicating the remaining time in the timer mode.	10																																								
TM-2	TM-2	Timer 2 display		10																																								
AL1	AL1	Alarm 1 set value	(appears only with alarm action type 1 to 10). Setting range: Note 1	10	Table 3 (Note 1)																																							
A1-L	A1-L	Alarm 1 low limit set value	(appears only with alarm action type 16 to 31). Setting range: Note 1	10	Table 3 (Note 1)																																							
A1-H	A1-H	Alarm 1 high limit set value		10	Table 3 (Note 1)																																							
AL2	AL2	Alarm 2 set value	(appears only with alarm action type 1 to 10). Setting range: Note 1	10	Table 3 (Note 1)																																							
A2-L	A2-L	Alarm 2 low limit set value	(appears only with alarm action type 16 to 31). Setting range: Note 1	10	Table 3 (Note 1)																																							
A2-H	A2-H	Alarm 2 high limit set value		10	Table 3 (Note 1)																																							
LoC	LoC	Key lock	Setting of key lock status. <table border="1" style="margin-left: auto; margin-right: auto;"> <thead> <tr> <th rowspan="2"></th> <th colspan="2">All parameters</th> <th colspan="2">SV</th> </tr> <tr> <th>Front key</th> <th>Comm-unication</th> <th>Front key</th> <th>Comm-unication</th> </tr> </thead> <tbody> <tr> <td>0</td> <td style="text-align: center;">○</td> <td style="text-align: center;">○</td> <td style="text-align: center;">○</td> <td style="text-align: center;">○</td> </tr> <tr> <td>1</td> <td style="text-align: center;">×</td> <td style="text-align: center;">○</td> <td style="text-align: center;">×</td> <td style="text-align: center;">○</td> </tr> <tr> <td>2</td> <td style="text-align: center;">×</td> <td style="text-align: center;">○</td> <td style="text-align: center;">○</td> <td style="text-align: center;">○</td> </tr> <tr> <td>3</td> <td style="text-align: center;">○</td> <td style="text-align: center;">×</td> <td style="text-align: center;">○</td> <td style="text-align: center;">×</td> </tr> <tr> <td>4</td> <td style="text-align: center;">×</td> <td style="text-align: center;">×</td> <td style="text-align: center;">×</td> <td style="text-align: center;">×</td> </tr> <tr> <td>5</td> <td style="text-align: center;">×</td> <td style="text-align: center;">×</td> <td style="text-align: center;">○</td> <td style="text-align: center;">×</td> </tr> </tbody> </table>		All parameters		SV		Front key	Comm-unication	Front key	Comm-unication	0	○	○	○	○	1	×	○	×	○	2	×	○	○	○	3	○	×	○	×	4	×	×	×	×	5	×	×	○	×	0	
	All parameters		SV																																									
	Front key	Comm-unication	Front key	Comm-unication																																								
0	○	○	○	○																																								
1	×	○	×	○																																								
2	×	○	○	○																																								
3	○	×	○	×																																								
4	×	×	×	×																																								
5	×	×	○	×																																								

○: Setting enable, ×: Setting disable

Note 1) Setting range : 0 to 100%FS (in case of absolute value alarm)
 -100 to 100%FS (in case of deviation alarm)

Note 2) Never set "TC" / "TC2" = 0

Operation/standby mode

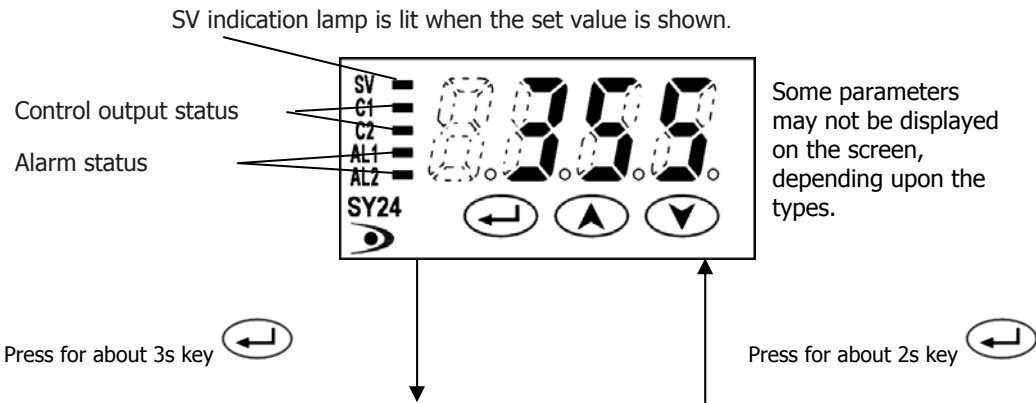

2nd block parameter					
Parameter display symbol	Parameter	Description of contents	Default setting	Remarks	
P	P	Proportional band	Setting range: 0.0 to 999.9% ON/OFF control when "P" = 0	5.0	
I	I	Integral time (reset)	Setting range: 0 to 3200 sec. No integral action when "I" = 0	240	
d	D	Derivative action time	Setting range: 0.0 to 999.9 sec. No derivative action when "d" = 0	60.0	
HYS	HYS	Hysteresis for ON/OFF control	Setting range: 0 to 50% FS	1	
Cool	Cool	Proportional band coefficient on cooling side	Sets the proportional band coefficient on the cooling side. (Setting range: 0.0 to 100.0) ON/OFF control when "Cool" = 0	1.0	
db	db	Deadband/overlap	Shifts the output value on the cooling side. (Setting range: -50.0 to 50.0%)	0.0	
Ctrl	Ctrl	Control algorithm	Type of control algorithm. (Setting range: PID, FUZZY, SELF)	PID	
TC	TC	Cycle time (control output 1)	Sets cycle time of control output 1. (Setting range: 1 to 150 sec)	30/2	Note 2
TC2	TC2	Cycle time (control output 2)	Sets cycle time of control output 2. (Setting range: 1 to 150 sec)	30/2	Note 2
P-n2	P-n2	Input type code	Type of input	As ordered	Table 1 (Page 4)
P-SL	P-SL	Lower limit of input range	Lower limit of input range (Setting range: -1999 to 9999)	As ordered	Table 2 (Page 4)
P-SU	P-SU	Upper limit of input range	Upper limit of input range (Setting range: -1999 to 9999)	As ordered	Table 2 (Page 4)
P-dP	P-dP	Setting of decimal point position	Select a decimal point position of display. (Setting range: 0 to 2)	As ordered	Table 2 (Page 4)
			 0 : No decimal point "1" "2"		
PVOF	PVOF	PV offset	Shift the display of process value (PV). (Setting range: -10 to 10%FS)	0	
P-dF	P-dF	Time constant of input filter	Time constant (Setting range: 0.0 to 900.0 sec.)	5.0	
ALM1	ALM1	Type of alarm 1	Setting types of alarm action (Setting range: 0 to 34)	0/5	Table 3 (Page 4)
ALM2	ALM2	Type of alarm 2		0/9	Table 3 (Page 4)
STAT	STAT	Ramp/soak status	Displays the current Ramp/Soak status. No setting can be made.	-	
PTn	PTn	Ramp/soak execute type	Selects the ramp/soak execute type. 1: Executes 1st to 4th segment. 2: Executes 5th to 8th segment. 3: Executes 1st to 8th segment.	1	
SV-1 to SV-8	SV-1 to SV-8	Ramp target SV-1 to SV-8	Sets the target SV for each ramp segment. (Setting range: 0 to 100%FS)	0%FS	
TM1r to TM8r	TM1r to TM8r	1st ramp segment time to 8th ramp segment time	Sets the time for each ramp segment. (Setting range: 0 to 99 hours and 59 minutes)	0.00	
TM1S to TM8S	TM1S to TM8S	1st soak segment time to 8th soak segment time	Sets the time for each soak segment. (Setting range: 0 to 99 hours and 59 minutes)	0.00	

Operation/standby mode

SV indication lamp is lit when the set value is shown.

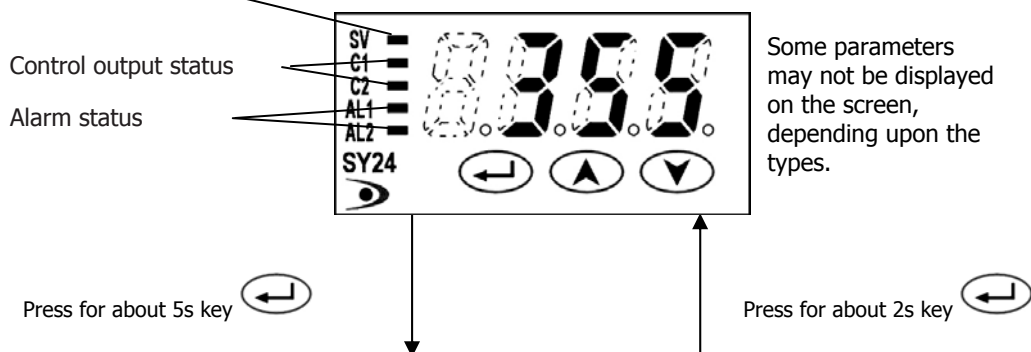

3rd block parameter					
Parameter display symbol	Parameter	Description of contents	Default setting	Remarks	
P-n1	P-n1	Control action	Selects the control action.	0	Table 4 (Page 44)
SV-L	SV-L	Lower limit of SV	Lower limit of SV (Setting range: 0 to 100%FS)	0%FS	
SV-H	SV-H	Upper limit of SV	Upper limit of SV (Setting range: 0 to 100%FS)	100%FS	
dLY1	dLY1	ON delay time of alarm 1	ON delay time setting for alarm output (Setting range: 0 to 9999 sec)	0	
dLY2	dLY2	ON delay time of alarm 2		0	
A1hY	A1hY	Hysteresis for alarm 1	Sets ON-OFF hysteresis for alarm output. (Setting range: 0 to 50%FS)	1	
A2hY	A2hY	Hysteresis for alarm 2		1	
A1oP	A1oP	Additional function of alarm 1	Additional function of alarm output (Setting range: 000 to 111)	000	Note 3
A2oP	A2oP	Additional function of alarm 2		000	Note 3
dl-1	dl-1	DI1 operation setting	Selects digital input 1 (DI1) function (Setting range: 0 to 12)	0(OFF)	6-7 (Page 35)
dl-2	dl-2	DI2 operation setting	Selects digital input 2 (DI2) function (Setting range: 0 to 12)	0(OFF)	6-7 (Page 35)
STno	STno	Station No.	Communication station No. (Setting range: 0 to 255)	1	
CoM	CoM	Parity setting	Parity setting. Baud rate is fixed at 9600 bps. (Setting range: 0 to 2)	0	6-6 (Page 34)
PYP	PYP	Code for PYP input type	Input type code used when communicating with PYP. See the OPERATION MANUAL (Initial value: K: 0 to 400°C)	34	
Ao-T	Ao-T	Retransmission output type	Selecting retransmission output type. 0: PV/ 1: Set point/ 2: Output/ 3: Error	0: PV	
Ao-L	Ao-L	Retransmission base scale	Setting retransmission base scale. (Setting range: -100 to 100%)	0%	
Ao-H	Ao-H	Retransmission span scale	Setting retransmission span scale. (Setting range: -100 to 100%)	100%	
dSP1 ... dSP13	dSP1 to dSP13	Parameter mask	Specifying parameter mask		

Note 3) De-energized: Contact opens when the alarm "ON".

SY48 – SY49 – SY96

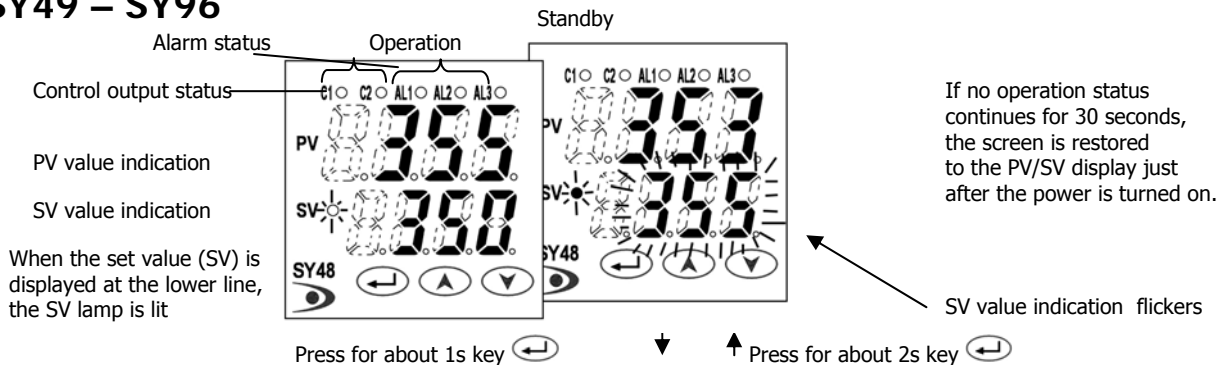

Parameters of the first block

Parameter display symbol	Parameter name		Description	Setting range	Value prior to delivery	User's set value	Parameter mask DSP
Stby	Stby	Standby setting	Switches between RUN and Standby for control.	on: Control standby (Output: OFF, Alarm: OFF) off: Control RUN	OFF		dSP1-1
CNod	CNod	Remote/Local setting	Switches between Remote and Local operations.	rEM: Remote LoCL: Local	LoCL		dSP13-8
ProG	ProG	Ramp-soak control	Switches between Start, Stop, and Hold for ramp-soak control.	oFF: Stop rUn: Start HLd: Hold	OFF		dSP1-2
LACH	LACH	Alarm latch cancel	Cancels the alarm latch.	0: Keeps the alarm latch. 1: Opens up the alarm latch.	0		dSP1-4
AT	AT	Auto-tuning	Used for setting the constants for F , L , and d by auto-tuning.	0: OFF (Resets the auto-tuning or does not use it.) 1: ON (Performs the auto-tuning in the SV standard type.) 2: ON (Performs the auto-tuning in low PV type (SV value-10%FS).)	0		dSP1-8
TM-1	TM-1	Timer 1 display	Displays the remaining time of timer 1.	- (Unit: seconds)	-		dSP1-16
TM-2	TM-2	Timer 2 display	Displays the remaining time of timer 2.	- (Unit: seconds)	-		dSP1-32
TM-3	TM-3	Timer 3 display	Displays the remaining time of timer 3.	- (Unit: seconds)	-		dSP1-64
AL1	AL1	Set value of alarm 1	Sets the value at which alarm 1 is detected.	AL1 is displayed when alarm type 1 is 0 to 15, or 32 to 34, and A1-H or A1-L is displayed when alarm type 1 is 16 to 31.	10		dSP1-128
A1-L	A1-L	Lower limit value of alarm 1	Sets the lower limit value at which alarm 1 is detected.	When the alarm type is deviation: -100 to 100%FS	10		dSP2-1
A1-H	A1-H	Upper limit value of alarm 1	Sets the upper limit value at which alarm 1 is detected.		10		dSP2-2
AL2	AL2	Set value of alarm 2	Sets the value during which alarm 2 is detected.	AL2 is displayed when alarm type 2 is 0 to 15 or 32 to 34, and A2-H or A2-L is displayed when alarm type 2 is 16 to 31.	10		dSP2-4
A2-L	A2-L	Lower limit value of alarm 2	Sets the lower limit value at which alarm 2 is detected.	When the alarm type is deviation: -100 to 100%FS	10		dSP2-8
A2-H	A2-H	Upper limit value of alarm 2	Sets the upper limit value at which alarm 2 is detected.		10		dSP2-16
AL3	AL3	Set value of alarm 3	Sets the value at which alarm 3 is detected.	AL3 is displayed when alarm type 3 is 0 to 15 or 32 to 34, and A3-H or A3-L is displayed when alarm type 3 is 16 to 31.	10		dSP2-32
A3-L	A3-L	Lower limit value of alarm 3	Sets the lower limit value at which alarm 3 is detected.	When the alarm type is deviation: -100 to 100%FS	10		dSP2-64
A3-H	A3-H	Upper limit value of alarm 3	Sets the upper limit value at which alarm 3 is detected.		10		dSP2-128
LoC	LoC	Key lock	Specifies whether or not to allow the change of parameters.	0: All settings are changeable both from the front panel and via communication. 1: All settings are unchangeable from the front panel, but changeable via communication. 2: Only the SV is changeable from the front panel, and all settings are changeable via communication. 3: All settings are changeable from the front panel, but unchangeable via communication. 4: All settings are unchangeable from the front panel and via communication. 5: Only the SV is changeable from the front panel, but all settings are unchangeable via communication.	0		dSP3-1

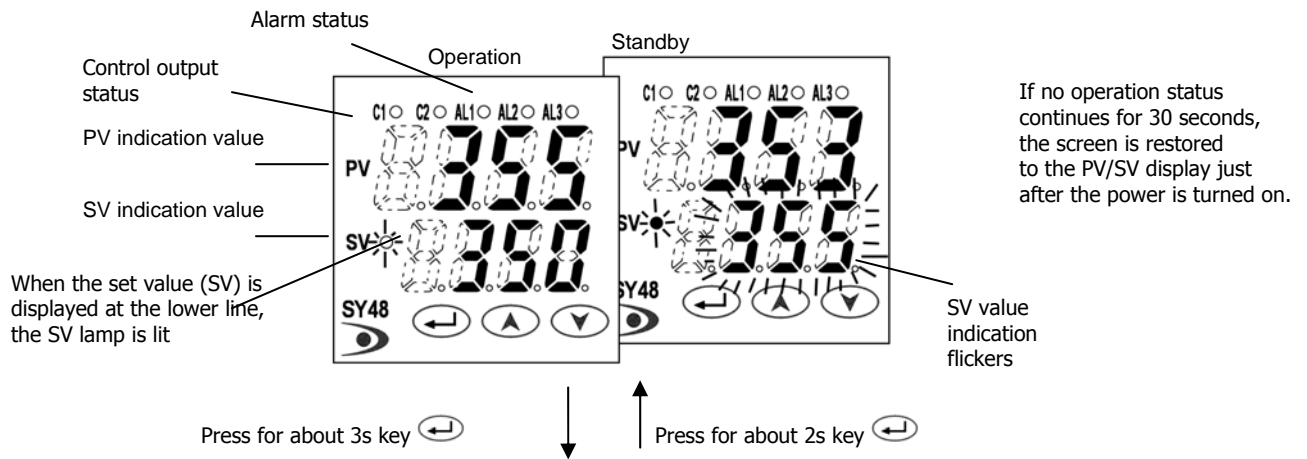

•Parameters of the second block

Parameter display symbol	Parameter name	Description	Setting range	Value prior to delivery	User's set value	Parameter mask DSP
P	P	Proportional band Set P to 0.0 to select the ON/OFF control (Two-position control).	0.0 to 999.9%	5.0		dSP3-2
I	I	Integral time Integration OFF at 0	0 to 3200 seconds	240		dSP3-4
d	D	Differential time Differentiation OFF at 0	0.0 to 999.9 seconds	60.0		dSP3-8
HYS	HYS	Hysteresis range for ON/OFF control Sets the hysteresis for ON/OFF control.	0 to 50%FS	1		dSP3-16
CoOL	CoOL	Cooling-side proportional band coefficient Automatically set by auto-tuning function. Selecting 0 switches to cooling-side ON/OFF operation.	0.0 to 100.0	1.0		dSP3-32
db	db	Dead band Shifts the cooling-side output value.	-50.0 to +50.0	0.0		dSP3-64
bAL	bAL	Manual reset value Do not modify the default value set at the factory.	-100 to 100%	0.0/50.0		dSP3-128
Rr	Ar	Anti-reset windup Automatically set by auto-tuning function.	0 to 100%FS	100%FS		dSP4-1
Ctrl	Ctrl	Control algorithm Selects the control algorithm.	PID: Runs normal PID control. FUZY: Runs PID control with fuzzy logic. SELF: Runs PID control with self-running.	PID		dSP4-2
SLFb	SLFb	PV (Measured value) stable range Sets the PV stable range for the self-tuning operation.	0 to 100%FS	2		dSP4-4
onoF	onoF	Setting HYS (Hysteresis) mode Selects the hysteresis operation at ON/OFF control.	oFF: Starts the two-position control at the values of SV+HYS/2 and SV-HYS/2. on: Starts the two-position control at the values of SV and SV+HYS, or SV and SV-HYS.	OFF		dSP4-8
TC	TC	Cycle time of control output 1 Not shown at 4-20mA DC output	RY, SSR: 1 to 150 seconds (Contact output = 30, SSR/SSC-drive output=2)	30/2		dSP4-16
TC2	TC2	Cycle time of control output 2 (cooling-side) Not shown at 4-20mA DC output	1 to 150 seconds (Contact output = 30, SSR/SSC-drive output=2)	30/2		dSP4-32
P-n2	P-n2	Input signal code Set this parameter when changing the types of temperature sensors.	1 to 16	Note 1		dSP4-64
P-SL	P-SL	Lower limit of measuring range	-1999 to 9999	Note 1		dSP4-128
P-SU	P-SU	Upper limit of measuring range	-1999 to 9999	Note 1		dSP5-1
P-dP	P-dP	Setting the decimal point position	0 to 2	Note 1		dSP5-2
PVOF	PVOF	PV (process value) offset Shift the display of the PV.	-10 to 10%FS	0		dSP5-8
SVOF	SVOF	SV (Setting value) offset Shift the SV. But the SV display is not changed.	-50 to 50%FS	0		dSP5-16
P-dF	P-dF	Time constant of input filter	0.0 to 900.0 seconds	5.0		dSP5-32
ALM1	ALM1	Alarm type 1 Sets the types of alarm operations.	0 to 34	0/5		dSP5-64
ALM2	ALM2	Alarm type 2 Sets the types of alarm operations.	0 to 34	0/9		dSP5-128
ALM3	ALM3	Alarm type 3 Sets the types of alarm operations.	0 to 34	0/0		dSP6-1
STAT	STAT	Status display of ramp-soak	-	OFF		dSP6-2
PTn	PTn	Selecting ramp-soak execute type Selects ramp-soak patterns.	1: Performs 1st to 4th segments. 2: Performs 5th to 8th segments. 3: Performs 1st to 8th segments.	1		dSP6-4
SV-1	SV-1	1st target value/ Switching-SV value Sets the 1st target SV of ramp-soak operation. / Selected at switching-SV function for DI1	Within the SV limit.	0%FS		dSP6-8
TM1r	TM1r	First ramp segment time Sets the first ramp segment time.	0 to 99h59m	0.00		dSP6-16
TM1S	TM1S	1st soak segment time Sets the 1st soak segment time.	0 to 99h59m	0.00		dSP6-32

•Parameters of the second block

Parameter display symbol	Parameter name	Description	Setting range	Value prior to delivery	User's set value	Parameter mask DS
Sv-2	Sv-2	2nd target SV	Sets the 2nd target SV of ramp-soak operation.	Within the SV limit.	0%FS	dSP6-64
TM2r	TM2r	2nd ramp segment time	Sets the 2nd ramp segment time.	0 to 99h59m	0.00	dSP6-12
TM2S	TM2S	2nd soak segment time	Sets the 2nd soak segment time.	0 to 99h59m	0.00	dSP7-1
Sv-3	Sv-3	3rd target SV	Sets the 3rd target SV of ramp-soak operation.	Within the SV limit.	0%FS	dSP7-2
TM3r	TM3r	3rd ramp segment time	Sets the 3rd ramp segment time.	0 to 99h59m	0.00	dSP7-4
TM3S	TM3S	3rd soak segment time	Sets the 3rd soak segment time.	0 to 99h59m	0.00	dSP7-8
Sv-4	Sv-4	4th target SV	Sets the 4th target SV of ramp-soak operation.	Within the SV limit.	0%FS	dSP7-16
TM4r	TM4r	4th ramp segment time	Sets the 4th ramp segment time.	0 to 99h59m	0.00	dSP7-32
TM4S	TM4S	4th soak segment time	Sets the 4th soak segment time.	0 to 99h59m	0.00	dSP7-64
Sv-5	Sv-5	5th target SV	Sets the 5th target SV of ramp-soak operation.	Within the SV limit.	0%FS	dSP7-12
TM5r	TM5r	5th ramp segment time	Sets the 5th ramp segment time.	0 to 99h59m	0.00	dSP8-1
TM5S	TM5S	5th soak segment time	Sets the 5th soak segment time.	0 to 99h59m	0.00	dSP8-2
Sv-6	Sv-6	6th target SV	Sets the 6th target SV of ramp-soak operation.	Within the SV limit.	0%FS	dSP8-4
TM6r	TM6r	6th ramp segment time	Sets the 6th ramp segment time.	0 to 99h59m	0.00	dSP8-8
TM6S	TM6S	6th soak segment time	Sets the 6th soak segment time.	0 to 99h59m	0.00	dSP8-16
Sv-7	Sv-7	7th target SV	Sets the 7th target SV of ramp-soak operation.	Within the SV limit.	0%FS	dSP8-32
TM7r	TM7r	7th ramp segment time	Sets the 7th ramp segment time.	0 to 99h59m	0.00	dSP8-64
TM7S	TM7S	7th soak segment time	Sets the 7th soak segment time.	0 to 99h59m	0.00	dSP8-12
Sv-8	Sv-8	8th target SV	Sets the 8th target SV of ramp-soak operation.	Within the SV limit.	0%FS	dSP9-1
TM8r	TM8r	8th ramp segment time	Sets the 8th ramp segment time.	0 to 99h59m	0.00	dSP9-2
TM8S	TM8S	8th soak segment time	Sets the 8th soak segment time.	0 to 99h59m	0.00	dSP9-4
Mod	Mod	Ramp-soak mode	Selects the power-on start, repeat, and standby functions for ramp-soak operations.	0 to 15	0	dSP9-8

Note 1: When a customer does not specify the settings while ordering, the following settings are selected as factory defaults.
 Thermocouple input : Thermocouple K Measured range: 0 to 400°C
 Resistance bulb input : Measured range: 0 to 150°C
 Voltage/Current input : Scaling: 0 to 100%

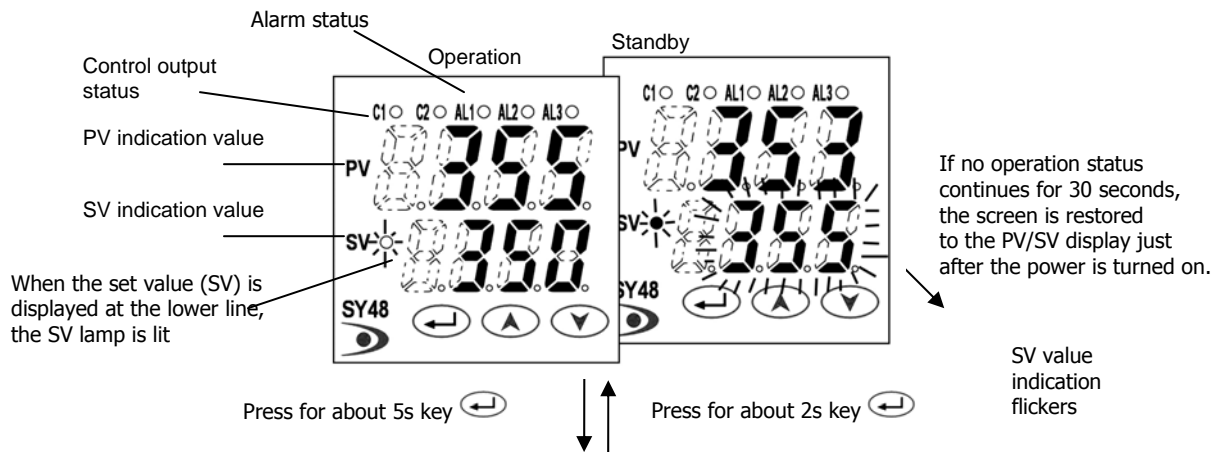

•Parameters of the third block

Parameter display symbol	Parameter name	Description	Setting range	Value prior to delivery	User's set value	Parameter mask DSP
P-nl	P-nl	Control action	Specifies control action and output at the input burn-out.	0 to 19	0/4	dSP9-16
Sv-L	Sv-L	SV (Setting value) lower limiter	Sets the lower limit of the SV.	0 to 100%FS	0%FS	dSP9-32
Sv-H	Sv-H	SV (Setting value) upper limiter	Sets the upper limit of the SV.	0 to 100%FS	100%FS	dSP9-64
dLY1	dLY1	Delay time 1	Delay time or timer value for alarm 1 relay.	0 to 9999 seconds	0	dSP9-128
dLY2	dLY2	Delay time 2	Delay time or timer value for alarm 2 relay.	0 to 9999 seconds	0	dSP10-1
dLY3	dLY3	Delay time 3	Delay time or timer value for alarm 3 relay.	0 to 9999 seconds	0	dSP10-2
CT	CT	Current transe display	Displays the current detector input value for HB alarm.	-	-	dSP10-4
Hb	Hb	HB (Set value of heater break alarm) setting	Sets the operation value that detects the heater break.	0 to 50.0A (Setting to 0.0A turns off the HB alarm.)	0.0	dSP10-8
A1hy	A1hy	Alarm 1 hysteresis	Sets the hysteresis range of ON and OFF of alarm 1.	0 to 50%FS	1	dSP10-16
A2hy	A2hy	Alarm 2 hysteresis	Sets the hysteresis range of ON and OFF of alarm 2.	0 to 50%FS	1	dSP10-32
A3hy	A3hy	Alarm 3 hysteresis	Sets the hysteresis range of ON and OFF of alarm 3.	0 to 50%FS	1	dSP10-64
A1oP	A1oP	Alarm 1 options		000 to 111	000	dSP10-128
A2oP	A2oP	Alarm 2 options		000 to 111	000	dSP11-1
A3oP	A3oP	Alarm 3 options		000 to 111	000	dSP11-2
PLC1	PLC1	Lower limit for output 1	Sets the lower limit for output 1.	-3.0 to 103.0%	-3.0	dSP11-4
PHC1	PHC1	Upper limit for output 1	Sets the upper limit for output 1.	-3.0 to 103.0%	103.0	dSP11-6
PLC2	PLC2	Lower limit for output 2	Sets the lower limit for output 2.	-3.0 to 103.0%	-3.0	dSP11-8
PHC2	PHC2	Upper limit for output 2	Sets the upper limit for output 2.	-3.0 to 103.0%	103.0	dSP11-32
PCUT	PCUT	Output limit types	Sets the limit types of outputs 1 and 2 (breaking the limit, or maintained within the limit).	0 to 15	0	dSP11-64
oUT1	oUT1	Output value (MV) display	Displays the value of output 1.	-	-	dSP11-128
oUT2	oUT2	Output value (MV) display	Displays the value of output 2.	-	-	dSP12-1
rCJ	rCJ	RCJ (Cold junction compensation) setting	Sets the cold junction compensation function to ON/OFF.	ON: Performs the RCJ (Cold junction compensation). OFF: Does not perform the RCJ (Cold junction compensation).	on	dSP12-2
GAIn	GAIn	PV gradient		0.001 to 2.000	1.000	dSP12-4
AdJO	AdJO	User-definable zero adjustment	Shifts the zero point of input value.	-50 to 50%FS	0	dSP12-8
AdJS	AdJS	User-definable span adjustment	Shifts the span of input value.	-50 to 50%FS	0	dSP12-16
di-1	di-1	DI1 (Digital input 1) operation	Sets the DI1 operations.	0 to 12	0	dSP12-32
di-2	di-2	DI2 (Digital input 2) operation	Sets the DI2 operations.	0 to 12	0	dSP12-64
STno	STno	Station No.	Sets the station No. for communication.	0 to 255	1	dSP12-128
CoM	CoM	Parity setting	Sets the parity for communication. (The baud rate is fixed at 9600bps.)	0: Odd parity 1: Even parity 2: No parity	0	dSP13-1
PCoL	PCoL	Communication protocol setting	Switches communication protocol between Modbus and ASCII.	0: Z-ASCII 1: Modbus (RTU)	Depends on the type.	dSP13-2
Ao-T	Ao-T	Re-transmission output type	Selecting re-transmission output type.	0: PV / 1: SV / 2: MV / 3: DV	0	dSP13-4
Ao-L	Ao-L	Re-transmission base scale	Setting re-transmission base scale.	-100.0 to 100.0%	0.0	dSP13-4
Ao-H	Ao-H	Re-transmission span scale	Setting re-transmission span scale.	-100.0 to 100.0%	100.0	dSP13-4
rENO	rENO	Remote SV input zero adjustment	Shifts the zero point of input value.	-50 to 50%FS	0	dSP13-16
rENS	rENS	Remote SV input span adjustment	Shifts the span point of the input value.	-50 to 50%FS	0	dSP13-16
r-dF	r-dF	Remote SV input filter constant	Sets the filter constant of remote SV input value.	0.0 to 900.00 seconds	0	dSP13-16
rSV	rSV	Remote SV input value display	Displays the input value of remote SV input.	-	-	dSP13-16
dSP1 dSP9 dP10 dP13	dSP1 dSP9 dP10 dP13	Parameter mask	Sets whether or not to display each parameter.	0 to 255	Ordering specification	-

6 Functions

6-1 ON/OFF control

- At ON/OFF control mode, output signal is as shown below.
Set parameter "P" = 0 for selecting the ON/OFF control mode.
Set the hysteresis to avoid chattering.
(Default setting: HYS = 1)

- Parameter setting and operation example

Example 1 : Reverse operation

Parameter	Setting value
P	0.0
P-n1	0 (or 1)
HYS	Any value

Relation between PV and SV	Output
PV > SV	OFF
PV < SV	ON

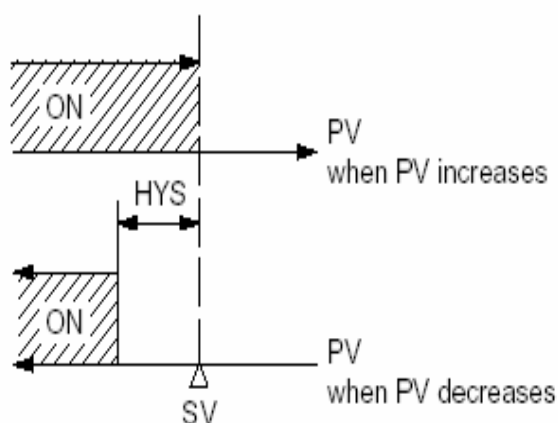

Example 2 : Direct operation

Parameter	Setting value
P	0.0
P-n1	2 (or 3)
HYS	Any value

Relation between PV and SV	Output
PV > SV	ON
PV < SV	OFF

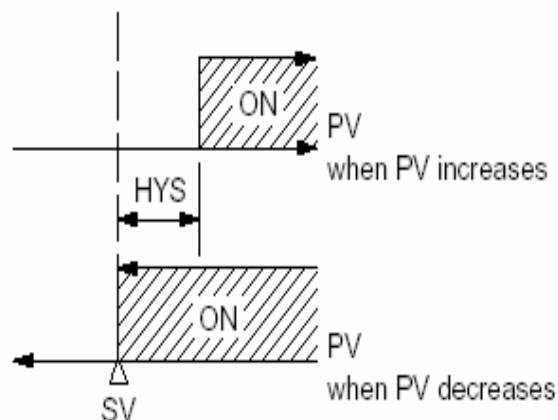

6-2 Auto-tuning

Autotuning is the automatic calculation and entering of the control parameters (P, I and D) into memory. Prior to the auto-tuning, complete the setting of input range (P-SL, P-SU, P-dP), a set value (SV), alarm setting (AL1, AL2), and cycle time (TC).

How to start the auto-tuning

Set the parameter AT as either "1" or "2" by using \uparrow or \downarrow key, and press the \leftarrow key to start the auto-tuning. Then the point indicator at the lower right starts blinking. At the completion of Auto-tuning, the point indicator stops blinking, then parameter AT is automatically set to 0.

	When auto-tuning is cancelled or not performed.	Standard type (auto-tuning at SV)	Low PV type (auto-tuning at 10%FS below SV.)
Setting code (AT)	0	1	2

① Standard type (AT=1)

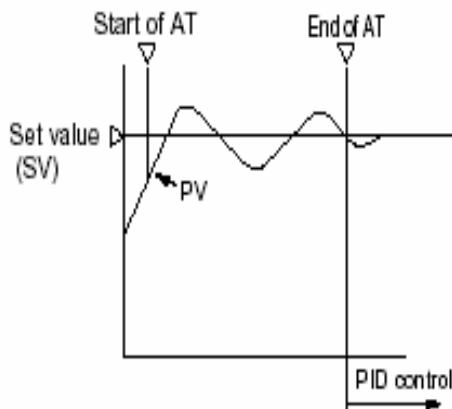

② Low PV type (AT=2) : Overshoot decreased at tuning.

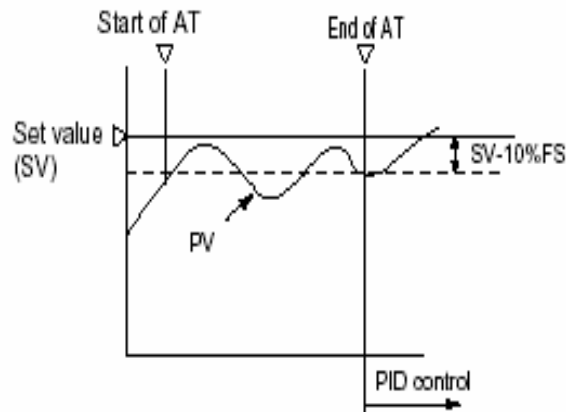

- (a) The P.I.D. parameter calculated by auto-tuning remains even if the power is turned off. If the power is turned off before the auto-tuning is completed, you must restart the auto-tuning.
- (b) The PV may be changed greatly depending on the process, because the control output is ON/OFF action (two position operation) in the auto-tuning. So, do not use the auto-tuning if the process does not allow a significant variation of PV.
In addition, the auto-tuning should not be used in any process such as pressure control and flow control, where a quick-response is required.
- (c) If the auto-tuning isn't completed in four hours, the auto-tuning is suspected to fail. In this case, check the wiring and parameters such as the control action, input type, etc.
- (d) Carry out the auto-tuning again, if there is any change in SV, input range (P-SL, P-SV or P-dP) or process condition. Perform the auto-tuning if fuzzy control is selected as the control algorithm.
- (e) When resetting the AT parameter, set the parameter to "0" once, then reset it.

6-3 Self-tuning

1) At power on, changing a set value or the external disturbance, tuning is made automatically so that the PID parameters are re-optimized.

It is useful where modification of PID parameters is required repeatedly due to frequent change in process condition.

If high controllability is important, select the PID or fuzzy control algorithm and use auto-tuning.

2) Setting for self-tuning

- ① Turn on the power and set the SV.
- ② Select SELF at "Ctrl" (control algorithm) parameter.
- ③ Turn off the power once.
- ④ Turn on the power of the whole system. The controller should be turned on at the same time with the other equipments or even later. Otherwise, the self tuning might not be performed successfully.
- ⑤ Self-tuning starts. Then the point indicator at the lower right corner starts blinking until the PID parameters are re-optimized.

Note) Whenever it is necessary to re-try the self-tuning, please set "Ctrl" = PID once, and then start the above setting procedure from the beginning.

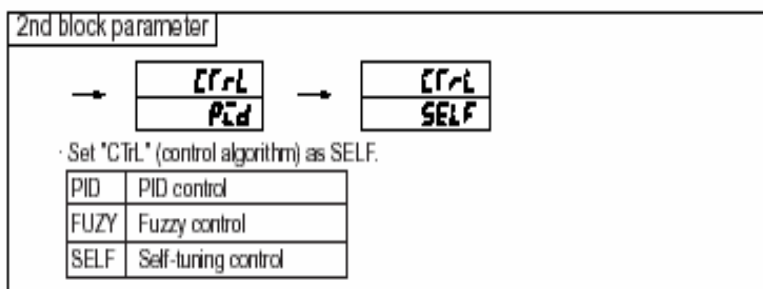

3) Self-tuning indication

SY24

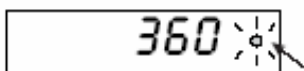

The point indicator at the lower right corner starts blinking until the PID parameters are re-optimized.

SY48-SY49-SY96

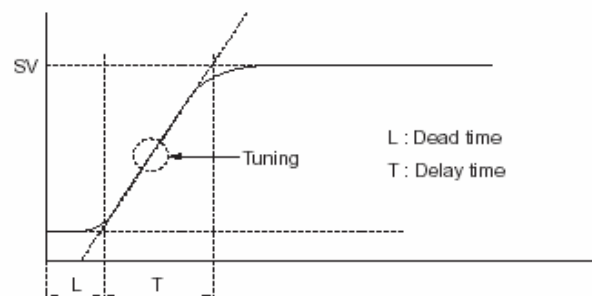

4) Self-tuning is executed by any of the following conditions.

- ① During temperature rise at power ON.
- ② During temperature rise at SV changing if necessary.
- ③ When control is out of stable condition and is judged as being out of stable condition continuously.

5) Self-tuning is not executed under the following conditions:

- ① During standby mode
- ② During ON/OFF control
- ③ During auto-tuning
- ④ During ramp/soak operation
- ⑤ During input error
- ⑥ With dual output ("P-n1" ≥ 4)
- ⑦ When P, I, D or Ar is manually set

Under the following conditions, self-tuning is canceled.

- ① When SV is changed.
- ② When Self-tuning can not be completed in about 9 hours after the start.

6) Cautions

- Turn on the power of the whole system. The controller should be turned on at the same time with the other equipments or even later. Otherwise, the self-tuning might not be performed successfully.
- Don't change the SV while the self-tuning is executing.
- Once PID parameters are optimized, the self-tuning is not executed at the next power on unless SV is changed.
- After the execution of self-tuning, if the controlability is not your expected level, please select PID or FUZZY at "Ctrl." parameter, and then, start the auto-tuning.

6-4 Alarm function (option)

1) Kinds of alarm

- Absolute value alarm, deviation alarm, combination alarm, and zone alarm are available. (For details, see Table 4, Alarm action type codes on page 4.)

ON delay function

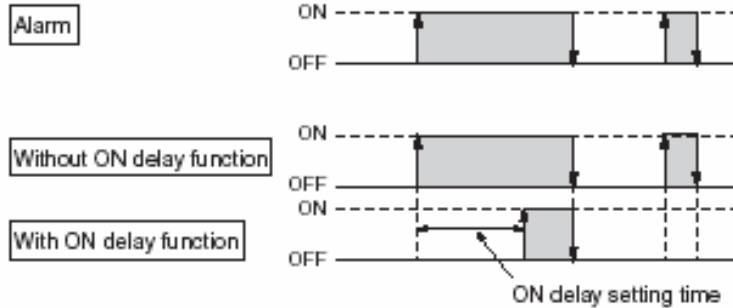

Energizing/de-energizing function

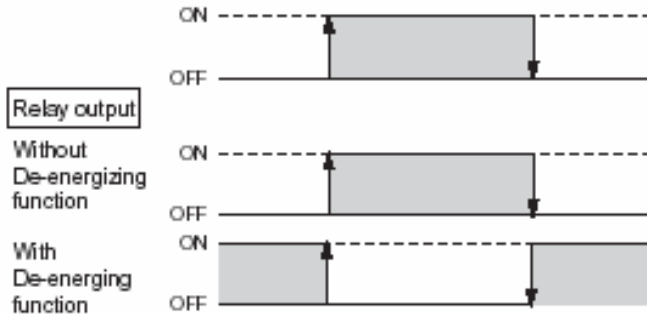

Caution When the power is turned OFF or in Standby mode, even if de-energizing function is turned ON, it cannot be output (it is kept OFF).

2) Alarm function SY24

No.	Function	Description	Parameters to set
①	Hysteresis	Set the hysteresis to avoid chattering.	Alarm 1 : A 2H Alarm 2 : A 2h
②	ON delay	The alarm is turned on with delay of a certain seconds as previously set after PV goes in the alarm band.	Alarm 1 : d 1 Alarm 2 : d 2
③	Alarm latch	Keeps the alarm ON status once an alarm is tured ON. To cancel the alarm latch, please take one of the following procedure.	
		i) Turn ON the controller again.	
		ii) Turn the alarm latch settings to OFF once.	Alarm 1 : A 1oP Alarm 2 : A 2oP
		iii) Use alarm latch cancel parameter.	LREH
		iv) Cancel by Digital input.	d 1-1, d 1-2
	v) Cancel by communication function.		
④	Error status alarm	Alarm is turned on when error indications are displayed.	Alarm 1 : A 1oP Alarm 2 : A 2oP
⑤	De-energizing	Alarm output can be de-energized.	Alarm 1 : A 1oP Alarm 2 : A 2oP

2) Alarm function SY48-SY49-SY96

No.	Function	Description	Parameters to set
①	Hysteresis	Set the hysteresis to avoid chattering.	Alarm 1 : A1hY Alarm 2 : A2hY Alarm 3 : A3hY
②	ON delay	The alarm is turned on with delay of a certain seconds as previously set after PV goes in the alarm band.	Alarm 1 : dLY1 Alarm 2 : dLY2 Alarm 3 : dLY3
③	Alarm latch	Keeps the alarm ON status once an alarm is turend ON. To cancel the alarm latch, please take one of the following procedure.	Alarm 1 : A1oP Alarm 2 : A2oP Alarm 3 : A3oP
		i) Turn ON the controller again.	
		ii) Turn the alarm latch settings to OFF once.	
		iii) Use alarm latch cancel parameter.	LACH
		iv) Cancel by Digital input.	dL-1, dL-2
v) Cancel by communication function.			
④	Error status alarm	Alarm is turned on when error indications are displayed.	Alarm 1 : A1oP Alarm 2 : A2oP Alarm 3 : A3oP
⑤	De-energizing	Alarm output can be de-energized.	Alarm 1 : A1oP Alarm 2 : A2oP Alarm 3 : A3oP

Combination of alarm functions

Please see the table as shown below.

O: Possible combination

X: Impossible combination

	Without HOLD/Timer	With HOLD	With Timer
Alarm latch	O	O	X
De-energizing	O	O	O
ON delay	O	Note 1	X
Alarm in error status	O	O	X

Note 1 If HOLD has not been canceled, the HOLD state is canceled as soon as the measured value goes out of alarm band. If HOLD has been canceled, ON delay is activated as soon as the measured value goes into the alarm band.

Cautions on alarms

No.	Cautions	Items/Classification
1	Note that the ON delay function is effective for alarm in error status.	Alarm in error status
2	Even during "Err" display, alarms in error status work.	Alarm at error indication
3	Even when "LLLL" or "UUUU" is displayed, an alarm function works normally.	
4	Alarm action type codes in No.12 to 15 are also included in No.24 to 27. It is, therefore, recommended to use No.24 to 27. In addition, please note when selecting No.12 to 15, setting in ALM2, dLY2, and A2hy are effective.	Alarm action type code
5	With the HB alarm, ON delay function, de-energizing function and latch function cannot be used.	HB alarm
6	The minimum alarm set value is -199.9.	Alarm set value
7	As the alarm action type changed, the alarm set value may also be changed accordingly.	
8	Note that all of alarm outputs are not provided at the standby condition.	Alarm at standby mode.
9	Error status alarm is not provided at the standby mode.	
10	The HOLD function is effective even if the PV value is in the hysteresis area when the power is turned ON.	
11	Select "0" for alarm action type code to use error status alarm.	

6-5 Ramp/soak function (option)

1. Function

Changes the set value (SV) as the time elapses according to a predetermined program pattern, as shown below.

Either 4 ramp/soak x 2 patterns or 8 ramp/soak x 1 pattern can be programmed. The first ramp starts from the process value (PV) just before the programming is executed.

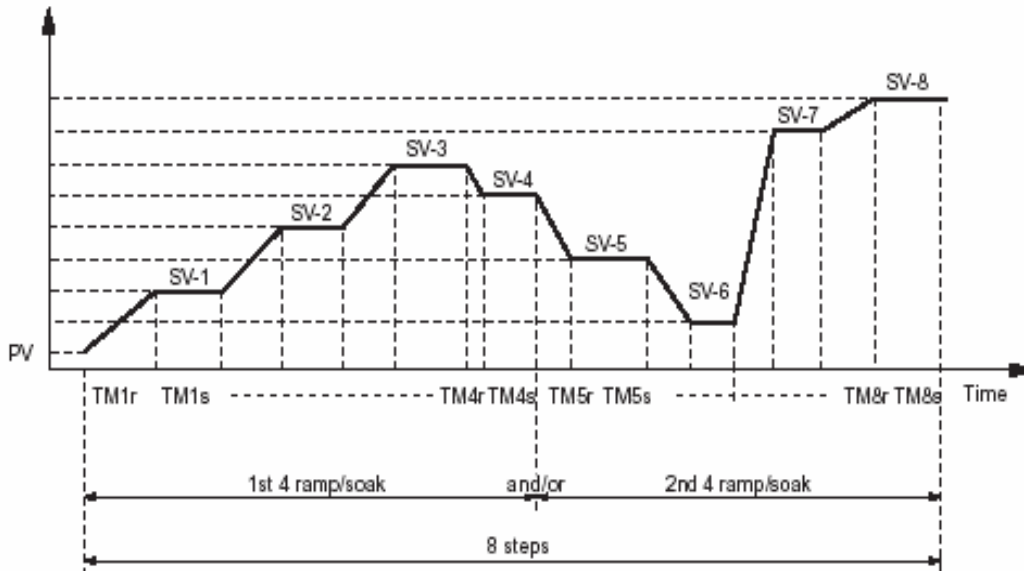

2. Setting

- Select the program pattern (PTn) and set the rUN at "ProG" parameter.
- Ramp/soak pattern can not be changed while ramp/soak program is running.

PTn	Pattern	Ramp/Soak
1	1	4
2	2	4
3	1 + 2	8

Note:

- The ramp/soak program is canceled if the controller becomes to standby mode.
Then, if the controller becomes to operation mode, the program doesn't run again.

6-6 Communication function (option)

SY24

1) Function

- Data can be written/read through the RS-485 communication.

2) Before using this function, please set related parameters as shown below.

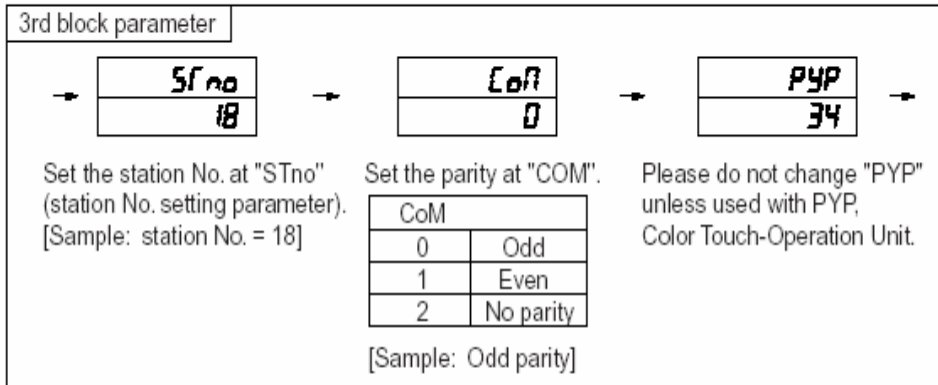

3) Caution

- Station No. can be set in the range of 0 to 255. (No communication is allowed with 0).
- After changing the setting of parity at "COM", please power off and re-start the controller.
- Baud rate is fixed to 9600 bps.
- Communication cannot be carried out with different communication protocol (such as ModbusRTU or Z-ASCII).

SY48-SY49-SY96

1) Function

- Internal data can be read/written via MODBUS or ASCII communications.

2) To use the function, the following three parameters must be set.

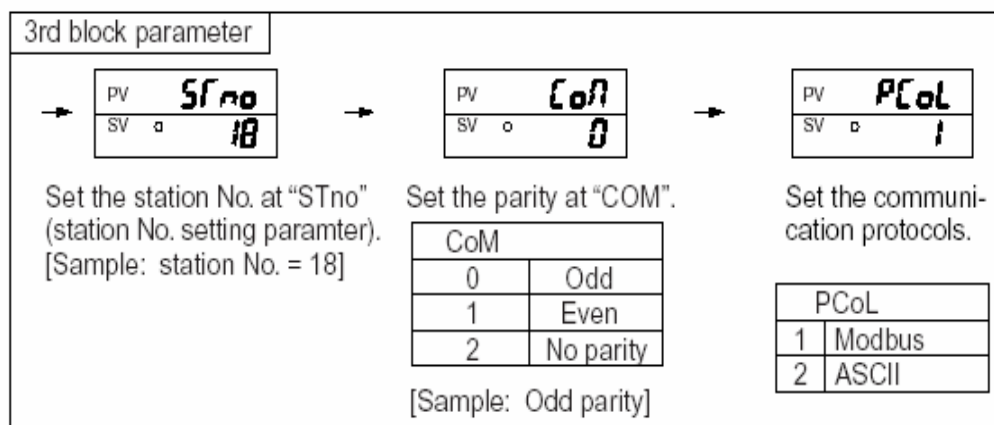

3) Caution

- Station No. can be set in the range of 0 to 255. (No communication is allowed when Modbus is selected, or Stno=0.)
- After changing the setting of parity at "COM", please power off and re-start the controller.
- Baud rate is fixed to 9600 bps.

6-7 Digital input (DI function) [option]

1) Function

- With Digital input, the following functions are available.
- ① SV switching
- ② Control mode; RUN/STANDBY selection
- ③ Ramp/soak RUN/RESET selection
- ④ Auto-tuning start/stop
- ⑤ Alarm latch cancel
- ⑥ Timer start/reset

2) To use DI function;

- Select the function with the parameter "di-1" or "di-2" referring to the Table shown below.

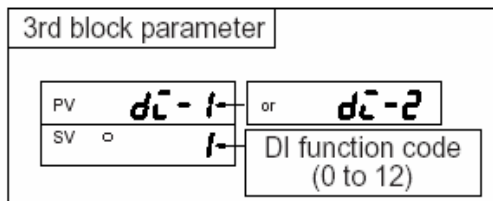

3) Table of DI function

DI function code	Function	Description
1	Set value (SV) switching	Switching between local SV and "SV-1" "SV-2" "SV-3"
2	Control mode, RUN/STANDBY	At standby mode, control is not provided and SV flickers.
3	Auto-tuning (standard) start	Start/Stop can be switched at the time of DI raising up or dropping down.
4	Auto-tuning (low PV) start	
5	All alarm latch cancel	When this function is not used, DI is not effective.
6	Alarm 1 latch cancel	
7	Alarm 2 latch cancel	
8	Alarm 3 latch cancel	
9	ALM1 timer	ON/OFF delay timer operation is available. The remaining time of the timer can be checked with timer-1 and -2 display parameters (first block).
10	ALM2 timer	
11	ALM3 timer	
12	Ramp/soak RUN/RESET	RUN/RESET of ramp/soak can be performed at the time of DI raising up or dropping down.

6-8 Other functions

The parameters "bAL" and "Ar" are masked at default setting.

If necessary to appear these parameters, please refer to the following procedure.

1) Function

- "bAL" and "Ar" are functions to suppress overshoot.
(Usually it is not necessary to change the setting.)

2) If they aren't optimum value, sometime you don't get the good control. Usually it is not necessary to set them.

3) "Ar"(Anti-reset wind-up) is automatically set by "Auto tuning".

1 bAL

MV is calculated by adding the offset (bAL) to MV', the result of PID calculation, from PV and SV.

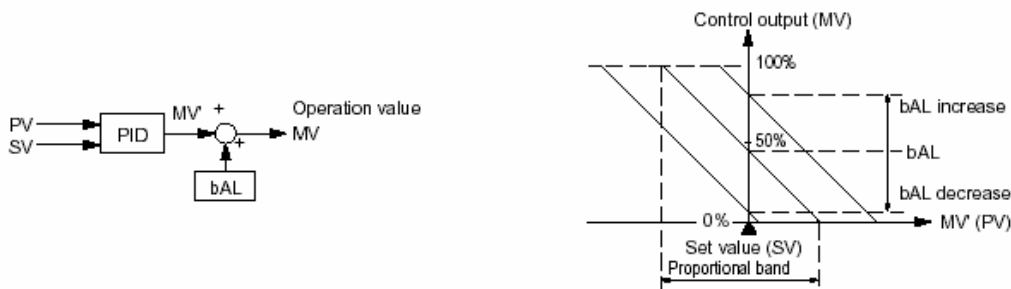

2 Ar

The integral range is $SV \pm Ar$.

Integral action don't work when PV is out of the range.

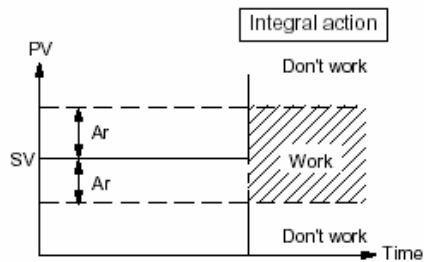

Mask/Unmask bAL and Ar

1 To unmask

- ① Display the "dSP3" in the third block parameter and then subtract 128 from current value.
- ② Display the "dSP4" in the third block parameter and then subtract 1 from current value.

2 To mask

- ① Display the "dSP3" in the third block parameter and then add 128 to current value.
- ② Display the "dSP4" in the third block parameter and then add 1 to current value.

6-9 Re-transmission output function

SY24

1) Function

It is the function that outputs one of signals as shown below with current such as 4 to 20mA dc.
Output type: PV, Setpoint, Output or Error

2) Before using this function, please set related parameters as shown below.

3rd block parameter

$\mathbf{Ao-f}$
0

→

$\mathbf{Ao-L}$
25.0

→

$\mathbf{Ao-H}$
75.0

Setting output type for
Retransmission.

Setting lower
limit scaling.

Setting upper
limit scaling.

Ao-T	
0	PV
1	SV
2	MV
3	DV

Example: Input K thermocouple, 0 ~ 800°C range
4 ~ 20mA signals are to be output when PV
values are at 200 - 600°C

Measured value

AO output

20(mA)
4(mA)

{ AO signal type PV value
600°C → 75% of input range
200°C → 25% of input range

(Setting)

$\mathbf{Ao-f}$ "0"
 $\mathbf{Ao-H}$ 75.0(%)
 $\mathbf{Ao-L}$ 25.0(%)

3) Note

- Don't set $\mathbf{Ao-L} \geq \mathbf{Ao-H}$.
- Setting unit for $\mathbf{Ao-L}$ and $\mathbf{Ao-H}$ is %FS.

SY48-SY49-SY96

1) Function

Outputs PV, SV, MV, and DV as a unified 4 to 20mA signal.

2) To use the Re-transmission output function,

(1) Set the output type to be outputted to Re-transmission output at $\mathbf{Ao-f}$.

Ao-T	Output type
0	PV
1	SV
2	MV
3	DV

(2) If output scaling is required, make the scaling setting at $\mathbf{Ao-L}$ and $\mathbf{Ao-H}$.

6-10 Remote SV function

SY48-SY49-SY96

1) Function

Controls SV (set value) by inputting 1 to 5V voltage signals by an external device.

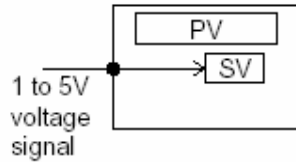

2) To perform remote operation.

(1) Connect the remote SV voltage signal to the remote SV input terminal.

(2) If required, perform zero point or span point adjustment of remote SV input.

rEN0 ... Parameter for zero point compensation of remote SV input

rENS ... Parameter for span point compensation of remote SV input

(3) Changing **ENod** parameter to **LoCL** → **rEN** switches to remote SV operation.

* **r-dF** is the setting for remote SV input filter. Use the equipment with the value set to 0.0 (set at the time of delivery) unless the change is required.

7 Setting of input type and control algorithm

1 Setting of the input type

* Skip this procedure if the input type is specified when you order.

① Please check if the input type set at "P-n2" is same as what you use.

Choose the sensor type you use from Table 1 shown below, and set the code at "P-n2".

(Example) For T thermo-couple, set "P-n2"=7.

(Note) Please refer to the following table for the modification of the input type.

TC ← → RTD (within Group I)*	Can be modified by changing "P-n2".
TC/RTD ← → 1 to 5Vdc (Group I)* 4 to 20mA dc (Group II)*	Modification not possible

TC : Thermocouple RTD : Resistance bulb (*Please refer to table 1)



② Is setting of input temperature range suitable for the sensor you use?

Standard range to each sensor is shown in Table 3. Select the temperature range suitable for the equipments you use, set lower/upper limit values to "P-SL" / "P-SU" respectively.

(Example) For temperature range 0 to 800 [°C] : Set "P-SL" and "P-SU" to 0 and 800 respectively.

(Note) If the span of setting ranges is smaller than the one of minimum standard range, the accuracy (% full scale) is influenced.

(Note) No standard range is given in case of 1 to 5VDC (4 to 20mA DC) input. Please set the range within the following limitation.

- Maximum span : 9999
- Lower limit : -1999
- Upper limit : 9999

Note:

Please set "P-n2": Input sensor type and "P-SL/P-SU/P-dP": input range setting prior to any other parameter settings. When "P-n2" and/or "P-SL/P-SU/P-dP" is changed, some other parameters may also be influenced. Please check all parameters before starting control.

2 Setting of the algorithm

* Read if the control doesn't work as you expect.

① Select the type of control output action.

	Control output action	Description	Setting procedure
Heating	Reverse	As PV increases, MV decreases. As PV decreases, MV increases.	Set parameter "P-n1" = 0 or 1. (Refer to Table 2)
Cooling	Direct	As PV increases, MV also increases. As PV decreases, MV also decreases.	Set parameter "P-n1" = 2 or 3. (Refer to Table 2)



② Control algorithm (ON/OFF, PID or fuzzy)

Type of control	Description	Setting procedure
ON/OFF control	Output is either ON (100%) or OFF (0%). (Suitable when frequent output switching is inconvenient.)	Set "P" =0.0. Refer to "6-1 ON/OFF control".
PID control	The output signal changes within the range at 0 to 100% according to PID calculation which determine the proportional of ON to OFF in each TC (cycle time).	Select PID at "CTRl". Execute auto-tuning so that optimum P.I.D can be calculated automatically. (PID parameters can be set spontaneously). *Refer to "6-2 Auto-tuning".
Fuzzy control	Fuzzy operation is added to PID providing control with less overshoot.	Select FUZY at "CTRl". Then execute the auto-tuning so that FUZZY control starts.
PID control with self-tuning.	At power on, changing a set value or the external disturbance, tuning is made automatically so that the PID parameters are re-optimized. It is useful where modification of PID parameters is required repeatably due to frequent change in process condition.	Select SELF at "CTRl". Refer to "6-3 Self-tuning".

8 Error indications

This controller has a display function to indicate several types of error code shown below. If any of the error codes is displayed, please eliminate the cause of error immediately. After the cause is eliminated, turn off the power once, and then re-start the controller.

SY24

Error code	Possible cause	Control output	Group
UUUU	① Thermocouple burnt out. ② RTD (A) leg burnt out. ③ PV value exceeds P-SU by 5% FS.	① when the burn-out control output is set as the lower limit (standard): OFF or 4 mA or less ② when the burn-out control output is set as the upper limit: ON or 20 mA or larger	I
LLLL	① The RTD leg (B or C) burnt out. ② The RTD leg (between A and B or A and C) short. ③ PV value is below P-SL by 5%FS. ④ 1 to 5 VDC or 4 to 20mADC wiring open or short.		
LLLL	① PV value < -1999. Note) In case of RTD input, "LLLL" is not displayed even if the temperature becomes below -150 °C.	Control is continued until the value reaches -5% FS or less, after which burn-out condition will occur.	II
Err (SV indication flickers)	Incorrect range setting (P-SL/P-SU).	OFF or 4mA or less	
FALF	Fault in the control.	Undefined (Stop using this controller immediately.) Contact with Fuji Electric Co.,Ltd. or the nearest representatives.	

SY48-SY49-SY96

Error code	Possible cause	Control output	Group
UUUU	① Thermocouple burnt out. ② RTD (A) line burnt out. ③ PV value exceeds P-SU by 5% FS.	① when the burn-out control output is set as the lower limit (standard): OFF or 4 mA or less ② when the burn-out control output is set as the upper limit: ON or 20 mA or larger	I
LLLL	① The RTD line (B or C) burnt out. ② The RTD line (between A and B or A and C) short. ③ PV value is below P-SL by 5%FS. ④ 1 to 5 VDC or 4 to 20mADC wiring open or short.		
LLLL	① PV value < -199.9 Note) In case of RTD input, "LLLL" is not displayed even if the temperature becomes below -150 °C.	Control is continued until the value reaches -5% FS or less, after which burn-out condition will occur.	II
AL3 lamp lit	Break of the heater (when provided with heater break alarm)	Normal control	
Err (SV indication flickers)	Incorrect range setting (P-SL/P-SU).	OFF or 4mA or less	
PV not displayed	Incorrect DP13 setting. Add 64 to set value of DP13 to display PV.	Normal control	

SY-24 MODEL

[Table 1] Input type code

Parameter : P-n2

Group	Input type	Code	Group	Input type	Code
I	RTD	1	II	1 to 5V DC, 4 to 20mA DC	16
	· Pt100 (IEC)				
	Thermocouple	In case of 4 to 20mA DC input, mount a 250Ω resistor enclosed in the package box. · Modification			
	· J			2	
	· K			3	
	· R			4	
	· B			5	
	· S			6	
	· T			7	
	· E			8	
· N	12				
· PL-II	13				

TC ↔ RTD (within Group I)	Can be modified by changing "P-n2"
TC/RTD ↔ $\begin{matrix} 1 \text{ to } 5 \text{ V DC} \\ 4 \text{ to } 20 \text{ mA DC} \end{matrix}$ (Group I) ↔ (Group II)	Modification is not possible

[Table 2] Input range (Standard range)

Parameter : P-SL, P-SU, P-dP

Input signal type		Range (°C)	Range (°F)	Input signal type		Range (°C)	Range (°F)
RTD (IEC)	Pt100 Ω	0 to 150	32 to 302	Thermo- couple	R	0 to 1600	32 to 2912
	Pt100 Ω	0 to 300	32 to 572		B	0 to 1800	32 to 3272
	Pt100 Ω	0 to 500	32 to 932		S	0 to 1600	32 to 2912
	Pt100 Ω	0 to 600	32 to 1112		T	-199 to 200	-328 to 392
	Pt100 Ω	-50 to 100	-58 to 212		T	-150 to 400	-238 to 752
	Pt100 Ω	-100 to 200	-148 to 392		E	0 to 800	32 to 1472
	Pt100 Ω	-150 to 600	-238 to 1112		E	-199 to 800	-328 to 1472
	Pt100 Ω	-150 to 850	-238 to 1562		N	0 to 1300	32 to 2372
Thermo- couple	J	0 to 400	32 to 752		PL-II	0 to 1300	32 to 2372
	J	0 to 800	32 to 1472		DC voltage	1 to 5VDC	-1999 to 9999 (Scaling is possible) • Maximum span : 9999 • Lower limit : -1999 • Upper limit : 9999
	K	0 to 400	32 to 752				
	K	0 to 800	32 to 1472				
	K	0 to 1200	32 to 2192				

Note 1) Except for the following, the input accuracy is $\pm 0.5\% \text{ FS} \pm 1 \text{ digit} \pm 1^\circ\text{C}$ (Input accuracy does not be guaranteed for the ranges of measurement other than in the table above.)
 R thermocouple 0 to 400 °C } . in these ranges, this controller may display an incorrect
 B thermocouple 0 to 500 °C } process value due to the characteristic of the sensor.

Note 2) In case a measuring range of -150 to 600 °C or -150 to 850 °C is used for resistance bulb input, temperatures below -150 °C does not be indicated correctly. Therefore, "LLLL" does not appear despite a continuous fall below -150 °C.

Note 3) If the resistance bulb or thermocouple is used at a temperature below the lowest value in the measurement range, the input accuracy cannot be guaranteed.

Note 4) Addition of decimal point is impossible if the input range or span is larger than 999.9 at the RTD/thermocouple input.

[Table 3] Alarm action type code

Parameter : P-AH, P-AL

- Standard alarm code

	ALM1	ALM2	Alarm type	Action diagram
	0	0	No alarm	
Absolute value alarm	1	1	High alarm	
	2	2	Low alarm	
	3	3	High alarm (with hold)	
	4	4	Low alarm (with hold)	
Deviation alarm	5	5	High alarm	
	6	6	Low alarm	
	7	7	High/Low alarm	
	8	8	High alarm (with hold)	
	9	9	Low alarm (with hold)	
	10	10	High/Low alarm (with hold)	
Zone alarm	11	11	High/Low deviation alarm (ALM1/2 independent action)	
	-	12	High/Low absolute alarm	
	-	13	High/Low deviation alarm	
	-	14	High absolute /Low deviation alarm	
	-	15	High deviation /Low absolute alarm	

- Alarm code with dual set value

	ALM1	ALM2	Alarm type	Action diagram	
High/Low limit alarm	16	16	High/Low absolute alarm		
	17	17	High/Low deviation alarm		
	18	18	High absolute /Low deviation alarm		
	19	19	High deviation /Low absolute alarm		
	20	20	High/Low absolute alarm (with hold)		
	21	21	High/Low deviation alarm (with hold)		
	22	22	High absolute /Low deviation alarm (with hold)		
	23	23	High deviation /Low absolute alarm (with hold)		
	Zone alarm	24	24	High/Low absolute alarm	
		25	25	High/Low deviation alarm	
26		26	High absolute /Low deviation alarm		
27		27	High deviation /Low absolute alarm		
28		28	High/Low absolute alarm (with hold)		
29		29	High/Low deviation alarm (with hold)		
30		30	High absolute /Low deviation alarm (with hold)		
31		31	High deviation /Low absolute alarm (with hold)		

- Timer code

	ALM1	ALM2	Alarm type	Action diagram
Timer	32	32	ON delay timer	
	33	33	OFF delay timer	
	34	34	ON/OFF delay timer	

Point What is alarm with hold?

The alarm is not turned ON immediately even when the process value is in the alarm band. It turns ON when it goes out the alarm band and enters again.

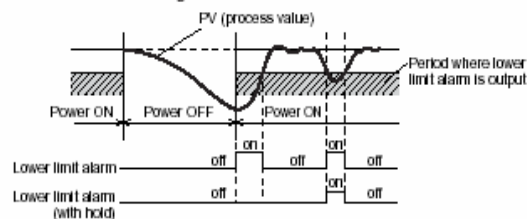

Note) · When alarm action type code is changed, alarm set value may also become different from previous settings.

Please check these parameters, turn off the power once, and then re-start the controller, before starting control.

- When selecting No.12 to 15, setting in ALM2, dLY2, and A2hy are effective, and output to the AL2 relay.

[Table 4] Control output action mode code

Parameter : P-n l

Code	Output	Control output action		Output at Burn-out*		
		Output 1	Output 2	Output 1	Output 2	
0	Single (Control output 1)	Reverse action	---	Lower limit	---	
1				Upper limit		
2		Direct action		Lower limit		
3				Upper limit		
4	Dual [Control output 1 and 2. Heating/Cooling]	Reverse action	Direct action	Lower limit	Lower limit	
5				Upper limit		
6				Lower limit	Upper limit	
7				Upper limit		
8		Direct action		Lower limit	Lower limit	
9				Upper limit		
10			Lower limit	Upper limit		
11					Upper limit	
12		Reverse action	Reverse action		Lower limit	Lower limit
13					Upper limit	
14				Lower limit	Upper limit	
15				Upper limit		
16	Direct action		Lower limit	Lower limit		
17			Upper limit			
18			Lower limit	Upper limit		
19					Upper limit	

(*) Outputs when Error Indication Group I.

Please refer to 8 (Error indications).

This is effective even in Standby mode.

Lower limit: OFF or 4mA or less

Upper limit: ON or 20mA or more

[Caution for dual output] (option)

(1) Parameter "I" and "D" can not be set separately.

(2) In case "P"=0 (ON/OFF control) for heating side, cooling side becomes ON/OFF control automatically.

(3) In case "Cool" =0.0, cooling side becomes ON/OFF control. And hysteresis is fixed at 0.5%FS.

SY-24 Specifications

Power voltage:	100 (-15%) to 240 (+10%), 50/60Hz 24V AC 50/60Hz, 24V DC
Power consumption:	6VA or less (100V AC), 8VA or less (240V AC, 24V AC/24V DC)
Relay contact output:	SPST contact, 220V AC/30V DC 3A (resistive load)
SSR/SSC driving output*1: (voltage pulse output)	ON: 15V DC (12 to 16V DC) OFF: 0.5V DC or less Maximum current: 20mA or less Resistive load: 600Ω or more
4-20mA DC output*1: Alarm output:	Allowable load resistor: 100 to 500Ω Relay contact (SPST contact) 220V AC / 30V DC 1A (resistive load)
Communication function*2: (RS-485 interface)	Transmission system: Half-duplex bit serial start-stop synchronization Transmission rate: 9600bps Transmission protocol: In conformity to Modbus RTU or Z-ASCII (PXR protocol) Transmission distance: Up to 500m (Total length) Connectable units: Up to 31units
Digital input:	Number of input: 2 inputs MAX. Input contact capacity: 5V, 2mA DC
Retransmission:	4 to 20mA DC Allowable load resistor: 500Ω or less Accuracy: ±0.3%FS (at 23°C)
Operating ambient temperature:	-10 to 50°C -10 to 45°C (for mounting close together)
Operating ambient humidity:	90%RH or less (no condensation)
Preservation temperature:	-20 to 60°C

*1: The following table shows the difference of outputs among other micro-controller SYROS Series models.

	SSR/SSC driving output		Allowable load Resistance for 4 to 20mA DC output
	Voltaje	Maximum current	
SY-24	15V DC	20mA	100 to 500Ω
SY48-SY49-SY96	24V DC	20mA	600Ω orless

*2: For the connection with a PC, communication converter is required.

SY48, SY49 and SY96 models

[Table 1] Input type code

Parameter : P-n2

Group	Input type	Code	Group	Input type	Code	
I	RTD · Pt100 (IEC)	1	II	1 to 5V DC, 4 to 20mA DC	16	
	Thermocouple · J · K · R · B · S · T · E · N · PL-II	2 3 4 5 6 7 8 12 13				
				· In case of 4 to 20mA DC input, mount a 250Ω resistor enclosed in the package box.		
				· Input signals can be selected within the same group.		
				· Modification		
				TC ↔ RTD (within Group I)	Can be modified by changing "P-n2".	
				TC/RTD ↔ (Group I)	1 to 5V DC 4 to 20 mA DC (Group II)	Modification is not possible.

[Table 2] Control output action code

Parameter : P-n1

Code	Output	Control output action		Output at Burn-out*			
		Output 1	Output 2	Output 1	Output 2		
0	Single (Control output 1)	Reverse action	---	Lower limit	---		
1				Upper limit			
2		Direct action		Lower limit			
3				Upper limit			
4	Dual [Control output 1 and 2.]	Reverse action	Direct action	Lower limit	Lower limit		
5				Upper limit	Upper limit		
6				Lower limit			
7				Upper limit			
8		Direct action		Lower limit	Lower limit		
9				Upper limit	Upper limit		
10			Lower limit				
11			Upper limit				
12		Reverse action	Reverse action	Reverse action	Lower limit	Lower limit	
13					Upper limit		
14					Lower limit		Upper limit
15					Upper limit		
16	Direct action		Lower limit		Lower limit		
17			Upper limit		Upper limit		
18			Lower limit				
19			Upper limit				

(*) Outputs when Error Indication Group I. Please refer to "8. Error indications". This is effective even in Standby mode.
Lower limit: OFF or 4mA or less
Upper limit: ON or 20mA or more

[Caution for dual output] (option)

- (1) Parameter "I" and "D" can not be set separately.
- (2) In case "P"=0 (ON/OFF control) for heating side, cooling side becomes ON/OFF control automatically.
- (3) In case "Cool" =0.0, cooling side becomes ON/OFF control. And hysteresis is fixed at 0.5%FS.

[Table 3] Input range (Standard range)

Parameter : P-SL, P-SU, P-dP

Input signal type		Range (°C)	Range (°F)	Input signal type		Range (°C)	Range (°F)
RTD (IEC)	Pt100Ω	0 to 150	32 to 302	Thermo-couple	R	0 to 1600	32 to 2912
	Pt100Ω	0 to 300	32 to 572		B	0 to 1800	32 to 3272
	Pt100Ω	0 to 500	32 to 932		S	0 to 1600	32 to 2912
	Pt100Ω	0 to 600	32 to 1112		T	-150 to 200	-238 to 392
	Pt100Ω	-50 to 100	-58 to 212		T	-150 to 400	-238 to 752
	Pt100Ω	-100 to 200	-148 to 392		E	0 to 800	32 to 1472
	Pt100Ω	-150 to 600	-238 to 1112		E	-150 to 800	-238 to 1472
	Pt100Ω	-150 to 850	-238 to 1562		N	0 to 1300	32 to 2372
					PL-II	0 to 1300	32 to 2372
Thermo-couple	J	0 to 400	32 to 752	DC voltage	1 to 5VDC	-1999 to 9999 (Scaling is possible) • Maximum span : 9999 • Lower limit : -1999 • Upper limit : 9999	
	J	0 to 800	32 to 1472				
	K	0 to 400	32 to 752				
	K	0 to 800	32 to 1472				
	K	0 to 1200	32 to 2192				

- Note 1) Except for the following, the input accuracy is $\pm 0.5\%$ FS ± 1 digit $\pm 1^\circ\text{C}$ (Input accuracy does not be guaranteed for the ranges of measurement other than in the table above.)
 R thermocouple 0 to 500 °C } , in these ranges, this controller may display an incorrect
 B thermocouple 0 to 400 °C } process value due to the characteristic of the sensor.
- Note 2) In case a measuring range of -150 to 600 °C or -150 to 850 °C is used for resistance bulb input, temperatures below -150 °C does not be indicated correctly. Therefore, "LLLL" does not appear despite a continuous fall below -150 °C.
- Note 3) If the resistance bulb or thermocouple is used at a temperature below the lowest value in the measurement range, the input accuracy cannot be guaranteed.
- Note 4) Addition of decimal point is impossible if the input range or span is larger than 999.9 at the RTD/thermocouple input.

[Table 4] Alarm action type code

Parameter : ALN1, ALN2, ALN3

Standard alarm code				Alarm code with dual set value				
ALM1	ALM2	ALM3	Alarm type	Action diagram				
0	0	0	No alarm					
Absolute value alarm	1	1	High alarm					
	2	2	Low alarm					
	3	3	High alarm (with hold)					
	4	4	Low alarm (with hold)					
Deviation alarm	5	5	High alarm					
	6	6	Low alarm					
	7	7	High/Low alarm					
	8	8	High alarm (with hold)					
	9	9	Low alarm (with hold)					
	10	10	High/Low alarm (with hold)					
Zone alarm	11	11	High/Low deviation alarm (ALM1/2 independent action)					
	-	12	High/Low absolute alarm					
	-	13	High/Low deviation alarm					
	-	14	High absolute /Low deviation alarm					
	-	15	High deviation /Low absolute alarm					
	-	-	-					
High/Low limit alarm	16	16	High/Low absolute alarm					
	17	17	High/Low deviation alarm					
	18	18	High absolute /Low deviation alarm					
	19	19	High deviation /Low absolute alarm					
	20	20	High/Low absolute alarm (with hold)					
	21	21	High/Low deviation alarm (with hold)					
	22	22	High absolute /Low deviation alarm (with hold)					
	23	23	High deviation /Low absolute alarm (with hold)					
	Zone alarm	24	24	High/Low absolute alarm				
		25	25	High/Low deviation alarm				
		26	26	High absolute /Low deviation alarm				
27		27	High deviation /Low absolute alarm					
28		28	High/Low absolute alarm (with hold)					
29		29	High/Low deviation alarm (with hold)					
30		30	High absolute /Low deviation alarm (with hold)					
31		31	High deviation /Low absolute alarm (with hold)					

Point

What is alarm with hold?
The alarm is not turned ON immediately even when the process value is in the alarm band. It turns ON when it goes out the alarm band and enters again.

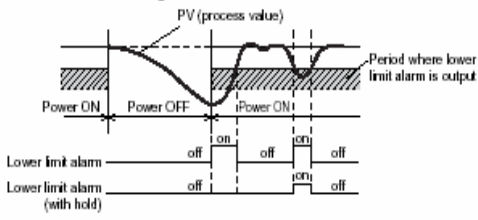

Timer code				Action diagram	
ALM1	ALM2	ALM3	Alarm type	DI	OUT
32	32	32	ON delay timer		
33	33	33	OFF delay timer		
34	34	34	ON/OFF delay timer		

- Note) · When alarm action type code is changed, alarm set value may also become different from previous settings.
Please check these parameters, turn off the power once, and then re-start the controller, before starting control.
- When selecting No.12 to 15, setting in ALM2, dLY2, and A2hy are effective, and output to the AL2 relay.
 - ALn means alarm set value (AL1, AL2 or AL3).
 - An-H means alarm set value (A1-H, A2-H or A3-H).
 - An-L means alarm set value (A1-L, A2-L or A3-L).
 - dLYn means alarm set value (dLY1, dLY2 or dLY3).

[Table 5] Control operation type code

Parameter : *Mod*

[MOD code list]

MOD	Power ON start	Output at END	Output at OFF	Repeat operation
0	Without	Control continued	Control continued	Without
1	Without	Control continued	Control continued	With
2	Without	Control continued	Standby mode	Without
3	Without	Control continued	Standby mode	With
4	Without	Standby mode	Control continued	Without
5	Without	Standby mode	Control continued	With
6	Without	Standby mode	Standby mode	Without
7	Without	Standby mode	Standby mode	With
8	With	Control continued	Control continued	Without
9	With	Control continued	Control continued	With
10	With	Control continued	Standby mode	Without
11	With	Control continued	Standby mode	With
12	With	Standby mode	Control continued	Without
13	With	Standby mode	Control continued	With
14	With	Standby mode	Standby mode	Without
15	With	Standby mode	Standby mode	With

[Description of functions]

1. Power ON start: Starts ramp/soak with the current PV value.
2. Output at END: Displays the output status at the time when ramp/soak is at END.
3. Output at OFF: Displays the output status at the time when ramp/soak is at OFF.
4. Repeat operation: After the ramp/soak step is terminated once, runs ramp/soak repeatedly.
The PV value set in the previous step is maintained in normal state (without repeat operation).

* Standby mode: Output -3%

Alarm OFF

Standby mode where no control operation is performed.





SY48, SY49 and SY96 Specifications

Power voltage:	100 (-15%) to 240V AC (+10%) 50/60Hz, 24V (±10%) AC/DC
Power consumption:	10VA or less (at 100V AC), 12VA or less (at 220V AC) 12VA or less (at 24V AC/DC)
Relay contact output:	Control output 1: SPDT contact, 220VAC /30VDC 3A (resistive load) Control output 2: SPST contact, 220VAC /30VDC 3A (resistive load)
SSR/SSC driving output *1: (voltage pulse output)	ON: 24V DC (17 to 25V DC) OFF: 0.5V DC or less Maximum current ; 20mA or less Resistive load 850Ω or more
4-20mA DC output:	Allowable load resistor 600Ω or less
Alarm output (up to 2 outputs):	Relay contact (SPST contact) 220V AC / 30V DC 1A (resistive load)
Heater disconnection alarm output:	Relay contact (SPST contact) 220V AC / 30V DC 1A (resistive load)
Communication function *2:	RS-485 interface Transmission system ; Half-dueplex bit serial start-stop synchronization Transmission rate ; 9600bps Transmission protocol ; In conformity to Modbus RTU or Z-ASCII (PXR protocol) Transmission distance ; Up to 500m (total length) Connectable units ; Up to 31units
Digital input :	Number of inputs; 2 inputs Judged as ON : 3VDC or higher Judged as OFF : 2VDC or lower Input contact capacity ; 5V, 2mA DC Input pulse width ; Min 0.5 sec
Re-transmission output:	Output accuracy ±0.3% or lower Permissible load resistance 600W or less
Remote SV input:	Input accuracy ±0.5% FS or lower (Without input break detection function) Set resolution 3000 or higher Input filtering function provided
Ambient temperature:	-10 to 50°C -10 to 45°C (when side by side mounting)
Operating ambient humidity:	90%RH or less (no condensation)
Preservation temperature:	-20 to 60°C
Time accuracy:	Within ±0.5%

*1: The following table shows the difference of outputs among other micro-controller SYROS Series models.

	SSR/SSC driving output		Allowable load Resistance for 4 to 20mA DC output
	Voltaje	Maximum current	
SY24	15V DC	20mA	100 to 500Ω
SY48-SY49-SY96	24V DC	20mA	600Ω or less

*2: For the connection with a PC, communication converter is required.

Model	SY24	SY48	SY49	SY96
Front view				
Format	24x48mm	48x48mm	48x96mm	96x96mm
Input (A)				
① Pt100/TC	SY24-1	SY48-1	SY49-1	SY96-1
② 1-5V/4-20mA	SY24-2	SY48-2	SY49-2	SY96-2
Control output 1 (B)				
① 1 Relay	SY24-1	SY48-1	SY49-1	SY96-1
② Pulse	SY24-2	SY48-2	SY49-2	SY96-2
③ 4-20mA	SY24-3	SY48-3	SY49-3	SY96-3
Control output 2 (C)				
None	SY24-0	SY48-0	SY49-0	SY96-0
① Relay	SY24-1	SY48-1	SY49-1	SY96-1
② Pulse	SY24-2	SY48-2	SY49-2	SY96-2
③ 4-20mA	SY24-3	SY48-3	SY49-3	SY96-3
④ Re-transmission (4-20mA)	-	SY48-4	SY49-4	SY96-4
Alarms/Setpoint (D)				
None	SY24-0	SY48-0	SY49-0	SY96-0
① 1 alarm	SY24-1	SY48-1	SY49-1	SY96-1
② 2 alarms	SY24-2	SY48-2	SY49-2	SY96-2
③ 3 alarms	-	SY48-3	SY49-3	SY96-3
④ Remote setpoint	-	SY48-4	SY49-4	SY96-4
⑤ Rem.setpoint+2 alarms.	-	SY48-5	SY49-5	SY96-5
Optional functions (E)				
None	SY24-0	SY48-0	SY49-0	SY96-0
① Heater break	-	SY48-1	SY49-1	SY96-1
② Ramp	SY24-2	SY48-2	SY49-2	SY96-2
③ 1 alarm+Heater break	-	SY48-3	SY49-3	SY96-3
Interface (F)				
None	SY24-0	SY48-0	SY49-0	SY96-0
① RS485 (Modbus)	SY24-1	SY48-1	SY49-1	SY96-1
② RS485 (ASCII)	SY24-2	-	-	-
③ 1 digital input	-	SY48-3	SY49-3	SY96-3
④ 2 digital inputs	SY24-4	SY48-4	SY49-4	SY96-4
⑤ 1 digital input+RS(1)	SY24-5	SY48-5	SY49-5	SY96-5
⑥ 1 digital input+RS(2)	SY24-6	SY48-6	SY49-6	SY96-6
⑦ Re-transmission (4-20mA)	SY24-7	-	-	-
⑧ Re-trans. + 1 digital input	SY24-8	-	-	-
Power supply (G)				
① 85 a 265VAC	SY24-1	SY48-1	SY49-1	SY96-1
② 24VAC/DC	SY24-2	SY48-2	SY49-2	SY96-2

Incompatibilities SY24

The options C1,C2,C3 are not available when combined with options D2.

The options F7 & F8 are not available when combined with options C1,C2,C3,D2,G2

Incompatibilities SY48

The options B2 & B3 are not available when combined with options E1 & E3.

The option C is not available when combined with options D2,D3,D5

The option D3 is not available when combined with options E1 & E3.

The option F5 are not available when combined with options D4, D5, E1 & E3.

If option F4 is selected you will have to choose between option E1 or any of the options C

Incompatibilities SY49/SY96

The options B2 & B3 are not available when combined with options E1 & E3.

The option D3 is not available when combined with options E1 & E3.

The option F5 is not available when combined with options E1 & E3, D4, D5, E1 y E3

If option F4 is selected you will have to choose between option E1 or any of the options C

WARRANTY

The instruments are warranted against defective materials and workmanship for a period of three years from date of delivery.

If a product appears to have a defect or fails during the normal use within the warranty period, please contact the distributor from which you purchased the product.

This warranty does not apply to defects resulting from action of the buyer such as mishandling or improper interfacing.

The liability under this warranty shall extend only to the repair of the instrument. No responsibility is assumed by the manufacturer for any damage which may result from its use.

DECLARATION OF CONFORMITY

<p><i>Manufacturer :</i> DITEL - Diseños y Tecnología S.A.</p> <p><i>Address :</i> Xarol 8-C P.I. Les Guixeres 08915 Badalona (Barcelona) ESPAÑA</p> <p><i>Declares, that the product :</i></p> <p>Name : Temperature regulator</p> <p>Model : SY24, SY48, SY49 and SY96</p> <p><i>Conforms with :</i> EMC 89/336/CEE LVD 73/23/CEE</p>	<p>Applicable Standards : EN61326(1997) Class A (Annex A)+A1(1998)+ A2(2001)+A3(Anenx A)</p> <p>Applicable Standards : EN61000-3-2 (2000) EN61000-3-3 (1995) + A1(2001)</p> <p>Applicable Standards : EN61010-1 Safety requirements for electrical equipment for measurement, control and laboratory use.</p>
---	---

Fecha: 18-02-2005

Signed: José M. Edo

Position: Technical Manager



NOTES

NOTES

A large, empty rectangular box with a thin black border, occupying most of the page. It is intended for the user to write their notes.

DISEÑOS Y TECNOLOGIA, S.A.

Travessera de Les Corts, 180

08028 BARCELONA - Spain

Tel : +34 - 93 339 47 58

Fax : +34 - 93 490 31 45

E-mail : dtl@ditel.es

www.ditel.es